

*Hickory Tree
Community Development District*

Meeting Agenda

September 6, 2023

AGENDA

Hickory Tree

Community Development District

219 E. Livingston St., Orlando, Florida 32801

Phone: 407-841-5524 – Fax: 407-839-1526

August 30, 2023

Board of Supervisors
Hickory Tree
Community Development District

Dear Board Members:

A meeting of the Board of Supervisors of the **Hickory Tree Community Development District** will be held on **Wednesday, September 6, 2023**, at **9:15 AM** at the **West Osceola Branch Library, 305 Campus Street, Celebration FL 34747**.

Zoom Video Link: <https://us06web.zoom.us/j/85120240522>

Zoom Call-In Number: 1-646-876-9923

Meeting ID: 851 2024 0522

Following is the advance agenda for the meeting:

Board of Supervisors Meeting

1. Roll Call
2. Public Comment Period (¹Speakers will fill out a card and submit it to the District Manager prior to the beginning of the meeting)
3. Approval of Minutes of the August 2, 2023 Board of Supervisors and Audit Committee Meetings
4. Presentation and Approval of Supplemental Engineer's Report dated September 6, 2023
5. Presentation and Approval of First Supplemental Assessment Methodology Report for Assessment Area One dated September 6, 2023
6. Consideration of Resolution 2023-07 Delegation Resolution (Series 2023 Assessment Area One Bonds)
7. Consideration of Developer Agreements (Series 2023 Assessment Area One Bonds):
 - A. True-Up Agreement
 - B. Collateral Assignment Agreement
 - C. Completion Agreement
 - D. Acquisition Agreement
 - E. Declaration of Consent

¹ Comments will be limited to three (3) minutes

- F. Consideration of Resolution 2023-08 Supplemental Delegation Assessment Resolution
- 8. Ratification of Audit Services Engagement Letter with DiBartolomeo, McBee, Hartley & Barnes, P.A.
- 9. Staff Reports
 - A. Attorney
 - B. Engineer
 - C. District Manager's Report
 - i. Approval of Check Register
 - ii. Balance Sheet & Income Statement
- 10. Other Business
- 11. Supervisors Requests and Audience Comments
- 12. Adjournment

MINUTES

**MINUTES OF MEETING
HICKORY TREE
COMMUNITY DEVELOPMENT DISTRICT**

The Audit Committee meeting of the Hickory Tree Community Development District was held Wednesday, **August 2, 2022** at 9:22 a.m. at the West Osceola Branch Library, 305 Campus Street, Celebration, Florida.

Present for the Audit Committee were:

Milton Andrade
Brian Walsh *by Zoom*
Jeff Shenefield
Garret Parkinson

Also present were:

Jill Burns	District Manager, GMS
Grace Kobitter	District Counsel, KVV Law
Rey Malave <i>via Zoom</i>	District Engineer, Dewberry

FIRST ORDER OF BUSINESS

Roll Call

Ms. Burns called the meeting to order and called the roll. Three committee members were present constituting a quorum.

SECOND ORDER OF BUSINESS

Public Comment Period

There were no members of the public members present.

THIRD ORDER OF BUSINESS

**Review of Proposals and Tally of Audit
Committee Members Rankings**

A. DiBartolomeo, McBee, Hartley & Barnes

B. Grau & Associates

Mr. Shenefield reviewed his ranking for the Board. His ranking for DiBartolomeo was 20 points for proposer's experience, 20 points for ability of personnel, 20 points for understanding scope of work, 20 points for ability to furnish required services, and 20 points for price totaling 100 points. Grau & Associates received 20 points in the first four categories and received 19 points

for price with a total of 99 points. Mr. Shenefield suggested ranking DiBartolomeo #1 and Grau & Associates #2.

On MOTION by Mr. Andrade, seconded by Mr. Parkinson, with all in favor, Ranking DiBartolomeo, McBee, Hartley & Barnes #1, was approved.

FOURTH ORDER OF BUSINESS

Adjournment

On MOTION by Mr. Andrade, seconded by Mr. Parkinson, with all in favor, the meeting was adjourned.

Secretary/Assistant Secretary

Chairman/Vice Chairman

**MINUTES OF MEETING
HICKORY TREE
COMMUNITY DEVELOPMENT DISTRICT**

The regular meeting of the Board of Supervisors of the Hickory Tree Community Development District was held Wednesday, **August 2, 2023** at 9:18 a.m. at the West Osceola Branch Library, 305 Campus Street, Celebration, Florida.

Present and constituting a quorum:

Milton Andrade	Chairman
Brian Walsh <i>via Zoom</i>	Vice Chairman
Jeff Shenefield	Assistant Secretary
Garret Parkinson	Assistant Secretary

Also present were:

Jill Burns	District Manager, GMS
Grace Kobitter	District Counsel, KVV Law
Rey Malave <i>via Zoom</i>	District Engineer, Dewberry

FIRST ORDER OF BUSINESS

Roll Call

Ms. Burns called the meeting to order and called the roll. Three Board members were present constituting a quorum.

SECOND ORDER OF BUSINESS

Public Comment Period

There were no members of the public present for the meeting.

THIRD ORDER OF BUSINESS

**Approval of Minutes of the April 5, 2023
Board of Supervisors Meeting and Audit
Committee Meeting**

Ms. Burns presented the minutes of the April 5, 2023 Board of Supervisors and Audit Committee meeting. She asked if the Board had any questions or changes to those meeting minutes. The Board had no changes to the minutes.

On MOTION by Mr. Shenefield, seconded by Mr. Parkinson, with all in favor, the Minutes of the April 5, 2023 Board of Supervisors and Audit Committee Meetings, were approved.

FOURTH ORDER OF BUSINESS

Acceptance of Rankings of the Audit Committee and Authorizing Staff to Send Notice of Intent to Award

Ms. Burns noted that the Audit Committee met prior to the Board meeting and ranked DiBartolomeo #1 and Grau & Associates #2.

On MOTION by Mr. Shenefield, seconded by Mr. Parkinson, with all in favor, Accepting the Ranking of the Audit Committee and Authorizing Staff to Send a Notice of Intent to Award to DiBartolomeo, McBee, Hartley, and Barnes, was approved.

FIFTH ORDER OF BUSINESS

Public Hearing

A. Public Hearing on the Adoption of the Fiscal Year 2024 Budget

Ms. Burns asked for a motion to open the public hearing.

On MOTION by Mr. Shenefield, seconded by Mr. Parkinson, with all in favor, Opening the Public Hearing, was approved.

Ms. Burns stated for the record that there were no members of the public present to provide public comments, and she asked for a motion to close the public hearing.

On MOTION by Mr. Shenefield, seconded by Mr. Parkinson, with all in favor, Closing the Public Hearing, was approved.

i. Consideration of Resolution 2023-04 Adopting the District’s Fiscal Year 2024 Budget and Appropriating Funds

Ms. Burns stated that this budget had no major changes since the Board saw it at the last meeting. She noted that the budget was developer funded so the costs will only be billed as incurred. She stated that they included a small field contingency based on the development timelines that were provided to management.

On MOTION by Mr. Shenefield, seconded by Mr. Andrade, with all in favor, Resolution 2023-04 Adopting the District’s Fiscal Year 2024 Budget and Appropriating Funds, was approved.

ii. Consideration of Fiscal Year 2023/2024 Developer Funding Agreement

Ms. Burns stated that this agreement is with Clayton Properties Group and that entity will fund the operations and maintenance of the District for the upcoming year.

On MOTION by Mr. Andrade, seconded by Mr. Parkinson, with all in favor, the Fiscal Year 2023/2024 Developer Funding Agreement, was approved.

SIXTH ORDER OF BUSINESS

**Consideration of Resolution 2023-05
Appointing an Assistant Treasurer**

Ms. Burns stated the this resolution will appoint Darrin Mossing, Sr. as the Assistant Treasurer.

On MOTION by Mr. Andrade, seconded by Mr. Shenefield, with all in favor, Resolution 2023-05 Appointing an Assistant Treasurer, was approved.

SEVENTH ORDER OF BUSINESS

**Consideration of Resolution 2023-06
Designation of a Regular Monthly Meeting
Date, Time, and Location for Fiscal Year
2024**

Ms. Burns stated that their regular monthly meeting date, time, and location would remain the same as the prior fiscal year.

On MOTION by Mr. Andrade, seconded by Mr. Parkinson, with all in favor, Resolution 2023-06 Designation of a Regular Monthly Meeting Date, Time, and Location for Fiscal Year 2024, was approved.

EIGHTH ORDER OF BUSINESS

Staff Reports

A. Attorney

i. Memo Regarding Ethics Training for Elected Officials

Ms. Kobitter reviewed the ethics training memo for the Board. She noted that they are only required to complete four hours no matter how many Boards the Supervisors serve on.

B. Engineer

Mr. Malave had nothing to report to the Board.

C. District Manager’s Report

i. Approval of Check Register

Ms. Burns presented the check register totaling \$15,929.32.

On MOTION by Mr. Shenefield, seconded by Mr. Andrade, with all in favor, the Check Register, was approved.

ii. Balance Sheet & Income Statement

Ms. Burns noted that the financial statements were included in the agenda package for Board review.

iii. Presentation of Number of Registered Voters – 0

Ms. Burns stated that there were zero registered voters in the District.

NINTH ORDER OF BUSINESS

Other Business

There being no comments, the next item followed.

TENTH ORDER OF BUSINESS

Supervisors Requests and Audience Comments

There being no comments, the next item followed.

ELEVENTH ORDER OF BUSINESS

Adjournment

On MOTION by Mr. Andrade, seconded by Mr. Shenefield, with all in favor, the meeting was adjourned.

Secretary/Assistant Secretary

Chairman/Vice Chairman

SECTION IV

REFERENCE NO. 50149169

.....

HICKORY TREE COMMUNITY DEVELOPMENT DISTRICT

Supplemental Engineer's Report

SEPTEMBER 6, 2023



ORIGINAL

SUBMITTED BY
Dewberry Engineers Inc.
800 North Magnolia Avenue
Orlando, Florida 32803
407.843.5120

SUBMITTED TO
Hickory Tree
Community Development District
219 East Livingston Street
Orlando, Florida 32801
407.841.5524

Supplemental Engineer’s Report

Table of Contents

1. Introduction	3
2. Purpose and Scope	4
3. The Development	4
4. Capital Improvements	4
5. Capital Improvement Plan Components	4
5.1 Stormwater Management Facilities	4
5.2 Public Roadways	5
5.3 Water and Wastewater Facilities	5
5.4 Off-Site Improvements	5
5.5 Amenities and Parks	6
5.6 Electric Utilities and Lighting	6
5.7 Entry Feature	6
5.8 Miscellaneous	6
5.9 Permitting	6
6. Recommendation	6
7. Report Modification	7
8. Summary and Conclusion	7
9. Engineer’s Certification	7

Table of Tables

Table 1.1 Land Use Summary	3
Table 1.2 Lot Types	3
Table 5.1 Permit Status	6

List of Exhibits

Aerial Location Map..... Exhibit 1
Legal Description Phases 1 and 2A Exhibit 2A
Legal Description Phases 2B and 3 Exhibit 2B
District Boundary Map Exhibit 3
Zoning Map Exhibit 4
Future Land Use Map Exhibit 5
Drainage and Utilities Map Exhibit 6
Summary of Opinion of Probable Cost Exhibit 7A
Summary of District Facilities Exhibit 7B
Phasing Map Exhibit 8
Overall Site Plan Exhibit 9

1. Introduction

Hickory Tree Community Development District (the “District” or “CDD”) is located entirely within unincorporated Osceola County (“County”), Florida. It is generally located east of Lake Gentry Road, south of Hickory Tree Road, and west of Brick Lake. The District currently contains approximately 205 acres and is expected to consist of 797 single family residential lots of various sizes with recreation/amenity areas, parks, and associated infrastructure for the development. This supplemental report includes infrastructure to support Phases 1 and 2A of the District (“Assessment Area One”).

The CDD was established pursuant to County ordinance #2022-60, which was approved by the Board of County Commissioners on June 27, 2022, and effective on June 29, 2022. The District will own and operate the public roadways and stormwater management facilities, as well as the landscape, irrigation, signage, and recreational facilities within the development.

The master developer is Clayton Properties Group, Inc. (“Developer”), which is based in Lakeland, Florida. The development is approved as a Planned Development (PD) for residential units to be constructed in two phases with an estimated timetable of 2022 to 2026. A land use summary is presented in Table 1.1. The Project Assessment Area One is defined as a portion of the infrastructure, as described herein, necessary for development of Phases 1 and 2A of the District consisting of 91.94 acres.

Public improvements and facilities financed, acquired, and/or constructed by the District will be designed and constructed to conform to regulatory criteria from the County, South Florida Water Management District (SFWMD), and other applicable agencies with regulatory jurisdiction over the development. An overall estimate of the probable cost of the public improvements are provided in Exhibit 7 of this report.

The Capital Improvement Plan (CIP) set forth in the Master Engineer’s Report reflects the present intentions of the District and the landowners with the Assessment Area One Project to include the improvements necessary for development within Phases 1 and 2A. It should be noted that the location of the proposed facilities and improvements may be adjusted during the final design, permitting, and implementation phases. It should also be noted that these modifications are not expected to diminish the benefits to the property within the District. The District reserves the right to make reasonable adjustments to the development plan to meet applicable regulatory requirements of agencies with jurisdiction over the development while maintaining a comparable level of benefits to the lands served by the improvements. Changes and modifications are expected as changes in regulatory criteria are implemented.

Table 1.1 Land Use Summary

LAND USE SUMMARY	
LAND USE	AREA (AC)
Master Stormwater System	28.36 ac
Residential Land (Single-Family)	93.83 ac
Roadways Infrastructure & Public Facilities	34.36 ac
Open Space/Conservation Areas/Parks	48.45 ac
TOTAL	205.0 ac

Table 1.2 Lot Types

LOT TYPES		
LOT WIDTH	PHASES 1 AND 2A	NUMBER OF LOTS (TOTAL PROJECT)
75-ft SFR Lots		40
70-ft SFR Lots	8	14
60-ft SFR Lots		67
50-ft SFR Lots	262	374
45-ft SFR Lots	44	80
20-ft Townhome Lots	92	222
TOTAL	406	797

Implementation of any proposed facilities or improvements outlined in this report requires written approval from the District's Board of Supervisors. Estimated costs outlined in this report are based on the best available information, which includes, but is not limited to, previous experience with similar projects. Actual costs could be different than estimates because final engineering and specific field conditions, along with market factors and inflation, may affect construction costs.

All roadway improvements including sidewalks in the right-of-way and storm drainage collection systems (from the curb inlets to their connection to the stormwater ponds) within the development will be maintained by the District. Water distribution and wastewater collection systems (gravity lines, force mains, and lift stations) will be dedicated to the City of St. Cloud for ownership and maintenance upon completion.

2. Purpose and Scope

The purpose of this supplemental report is to provide engineering support for the funding of the proposed improvements within the District for the Assessment Area One Project. This report will identify the proposed public infrastructure to be constructed or acquired by the District along with an Opinion of Probable Construction Costs. The District will finance, construct, acquire, operate, and/or maintain all or specific portions of the proposed public infrastructure as part of the Assessment Area One Project.

The predominant portion of this report provides descriptions of the proposed public infrastructure improvements, determination of estimated probable construction costs, and the corresponding benefits associated with the implementation of the described improvements. Detailed site construction plans and specifications have not yet been completed and permitted for the improvements described herein. The engineer has considered and in specific instances has relied upon, the information and documentation prepared or supplied by others to prepare this Supplemental Engineer's Report.

3. The Development

The master development will consist of 797 residential units and associated infrastructure. The development is a planned residential community consisting of 205 acres east of Lake Gentry Road, south of Hickory Tree Road, and west of Brick Lake. It located entirely within unincorporated Osceola County. The land uses and zoning for the development are LDR (low density residential). The development will be constructed in two phases. The Assessment Area One Project will encompass Phases 1 and 2A.

4. Capital Improvements

The CIP consists of public infrastructure in the development. The primary portions of the CIP will provide funding for stormwater pond construction, roadways built to an urban roadway typical section, water, and sewer infrastructure including a lift station, and off-site improvements (including turn lanes and extension of water and sewer mains to serve the development).

There will be stormwater structures and conveyance culverts within the CIP, which will outfall into the various on-site stormwater ponds. These structures and pond areas comprise the overall stormwater facilities of the CIP. Installation of the water distribution and wastewater collection system (including lift stations) are also included in the CIP. Below-ground installation of telecommunications and cable television will occur but will not be funded by the District. Installation of streetlights and the incremental cost of undergrounding of power within the public rights-of-way or easements will be funded by the District. The recreational areas will have connectivity via sidewalks to the other portions of the District. The recreational areas will be accessed by the public roadways and sidewalks.

5. Capital Improvement Plan Components

The CIP for the District includes the following:

5.1 Stormwater Management Facilities

Stormwater will be discharged via roadway curb and gutter and storm inlets. Storm culverts convey the runoff into the proposed retention ponds for water quality treatment and attenuation. The proposed stormwater systems will utilize dry and wet retention for biological pollutant assimilation to achieve water

quality treatment. The design criteria for the District's stormwater treatment systems are regulated by the County and SFWMD.

Federal Emergency Management Agency (FEMA) Flood Insurance Rate Map (FIRM) Panel Numbers 12097C0290G, dated 06/18/2013, demonstrates that the property is located within Flood Zone X and AE. The 100-year flood volumes will be compensated as required the County and FEMA.

During the construction of stormwater management facilities, utilities, and roadway improvements, the contractor will be required to adhere to a Stormwater Pollution Prevention Plan (SWPPP) as required by the Florida Department of Environmental Protection (FDEP) as delegated by the Environmental Protection Agency (EPA). The SWPPP will be prepared to depict the proposed recommended locations of required erosion control measures and staked turbidity barriers specifically along the downgradient side of any proposed construction activity. The site contractor will be required to provide the necessary reports as required by the National Pollutant Discharge Elimination System (NPDES) General Permit with erosion control, its maintenance, and any rainfall events that occur during construction activity.

5.2 Public Roadways

The proposed public roadway sections will consist of asphalt and include Miami curbs or Type F curb and gutter on both sides of 24-foot roadways with 50-foot right-of-way, 36-foot roadways (entrance streets) with 78-foot right-of-way, and 26-foot roadways with 91-foot rights-of-way including 7-foot bike lanes. The proposed roadway sections will consist of stabilized subgrade, a lime rock, crushed concrete, or cement-treated base, and asphalt type roadway wearing surface. The proposed curb is to be 2-feet wide and placed along the edge of the proposed roadway section for purposes of protecting the integrity of the pavement and to provide stormwater runoff conveyance to the proposed stormwater inlets.

The proposed roadways will also require signing and pavement markings within the public rights-of-way, as well as street signs depicting street name identifications and addressing, which will be utilized by the residents and public. As stated above, the District's funding of roadway construction will occur for all public roadways.

5.3 Water and Wastewater Facilities

A potable drinking water distribution system inclusive of a water main, gate valves, fire hydrants, and appurtenances will be installed. The water service provider will be the City of St. Cloud. The water system will be designed to provide equal distribution and redundancy. The system will be installed within the proposed public rights-of-way and will provide potable drinking water (domestic) and fire protection services to serve the entire District.

A domestic wastewater collection system inclusive of gravity sanitary sewer mains and sewer laterals will be installed. The gravity sanitary sewer mains will be a minimum of eight (8)-inch diameter PVC pipe systems. The gravity sanitary sewer lines will be placed inside of the proposed public rights-of-way, under the proposed paved roadways. Sewer laterals will branch off from these sewer lines to serve the development. Lift stations are included within the CIP. Flow from the lift station shall be connected to a proposed force main that will pump to an existing force main that will connect to the City of St. Cloud's wastewater treatment facility.

The City of St. Cloud will provide the reclaimed water to be used for all irrigation within the CDD. The reclaimed water will be funded by the District and installed onsite within the roadways to provide for irrigation within the public right-of-way and other areas determined to need irrigation. Any water, sewer, or reclaim water pipes or facilities placed on private property will not be publicly funded.

5.4 Off-Site Improvements

The District will provide funding for the anticipated turn lanes, to be owned by Osceola County, at the development entrances. The site construction activities associated with the CIP are anticipated to be completed in four years. Upon completion, the required inspections will be performed, and final certifications of completion will be obtained from the County, SFWMD, and FDEP (water distribution and wastewater collection systems).

5.5 Amenities and Parks

The District will provide funding for an amenity center that is open to the residents and the public, consistent with rates, rules and policies to be adopted by the District, and to include the following: parking areas, restroom facilities, pool, all-purpose playfields, and walking trails to provide connectivity to the various amenity centers within the CDD. In addition, there will be passive parks throughout the development, which will include benches and walking trails.

5.6 Electric Utilities and Lighting

The electric distribution system thru the District is currently planned to be underground, The District presently intends to fund and construct the incremental cost of undergrounding of the electric conduits, transformer/cabinet pads, and electric manholes required by the Orlando utilities Commission (OUC), with OUC providing underground electrical service to the development. The CDD presently intends to fund the cost to purchase and install the street lighting along the internal roadways within the CDD. The District will retain ownership of the electric distribution system and streetlights and the OUC will provide the electrical service.

5.7 Entry Feature

Landscaping, irrigation, entry features, and walls where required as a buffer at the entrances and along the outside boundary of the development, will be provided by the District. Landscaping for the roadways will consist of sod, perennial flowers, shrubs, ground cover, and trees for the internal roadways within the CDD. Perimeter fencing will be provided at the site entrances and perimeters where required as a buffer. These items will be funded, owned, and maintained by the CDD.

5.8 Miscellaneous

The stormwater improvements, landscaping and irrigation, recreational improvements, street lighting, and certain permits and professional fees as described in this report are being financed by the District to benefit all the developable real property within the District. The construction and maintenance of the proposed public improvements will benefit the development for the intended use as a single-family/residential planned development such that all components of the CIP are interrelated and benefit all land uses within the District.

5.9 Permitting

Construction permits for all phases are required and include the County, SFWMD ERP, FDEP.

Following is a summary of required permits obtained or pending approval for the construction of the public infrastructure improvements for the District.

Table 5.1 Permit Status

PERMIT STATUS	
PERMITS/APPROVALS	APPROVAL/EXPECTED APPROVAL DATE
Zoning Approval	Residential Planned Unit Development (RPUD)
Preliminary Plat/Site Development Plan	Approved 07/13/2023
SFWMD ERP	Approved 02/13/2023
Construction Permits	Approved 08/23/2023
FDEP Sanitary Sewer General Permit	In process
FDEP Water Distribution General Permit	To be obtained
FDEP NOI	To be obtained

6. Recommendation

As previously described, the public infrastructure, as described, is necessary for the development and functional operation as required by the County. The site planning, engineering design, and construction plans for the infrastructure are in accordance with the applicable requirements of the County, SFWMD, and FDEP. It should be noted that the infrastructure will provide its intended use and function so long as

the construction and installation are in substantial conformance with the design construction plans and regulatory permits.

Items utilized in the Opinion of Probable Costs for this report are based upon the proposed plan infrastructure as shown on construction drawings incorporating specifications in the most current County, SFWMD, and FDEP regulations.

7. Report Modification

During the development and implementation of the designed public infrastructure improvements, it may be necessary to make modifications and/or deviations to the plans. However, if such deviations and/or revisions do not change the overall primary objective of the plan for such improvements, then the cost differences would not materially affect the proposed construction cost estimates.

8. Summary and Conclusion

The improvements, as outlined, are necessary for the functional development of the CDD and Phases 1 and 2A. The CDD is being designed in accordance with current government regulatory requirements. The development will serve its intended function provided the construction is in substantial compliance with the design. Construction of the development is based upon current development plans.

9. Engineer's Certification

It is our professional opinion that the public infrastructure costs for the CIP provided in this report are reasonable to complete the construction of the public infrastructure improvements. Furthermore, the public infrastructure improvements will benefit and add value to lands within the District and the value is at least the same as the costs for said improvements. Assets will be purchased by the District at the lesser of fair market value or actual cost. All improvements financed by the District will be on land owned by, or subject to a permanent easement in favor of, the District or another governmental entity.

The Opinion of Probable Costs for the public infrastructure improvements is only an estimate and is not a guaranteed maximum price. The estimated costs are based upon current unit prices and on our experience with ongoing and similar projects and basis in the County. However, labor market, future costs of equipment; materials, changes to the regulatory permitting agencies' activities, and the actual construction processes employed by the chosen site contractor are beyond the engineer's control. Due to this inherent opportunity for changes (upward or downward) in the construction costs, the total, final construction cost may be more or less than this estimate.

Based upon the presumption that the CIP construction continues in a timely manner, it is our opinion that the costs of the CIP proposed represent a system of improvements benefitting all developable property located within the District, are fair and reasonable, and that the District-funded improvements are assessable improvements within the meaning of Chapter 190, F.S. We have no reason to believe that the CIP improvements cannot be constructed at the cost described in this report. We expect the improvements to be constructed or acquired by the District with bond proceeds, as indicated within this report. We believe that the District will be well served by the improvements discussed in this report.

I hereby certify that the foregoing is a true and correct copy of the engineer's report for Hickory Tree Community Development District.



Reinardo Malavé, P.E.
Florida License No. 31588



ALLIGATOR LAKE

BRICK LAKE

LAKE GENTRY

Legend

 CDD BOUNDARY

SECT 4, T27S, R31E

APPROX. CDD BOUNDARY
AREA - 205.00 AC.

**EXHIBIT 1 - LOCATION MAP
HICKORY TREE CDD**

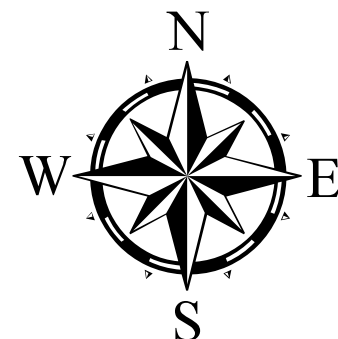

0 1,450 2,900

Feet

DATE: August 31, 2023

SKETCH OF DESCRIPTION

LEGAL DESCRIPTION

A parcel of land being all of Lots 3 through 6, 12 through 14, 19 and 30 and a portion of Lots 2, 11, 15, 18, 20, 21, 22, 29, 31, 34, 35, 36, 46 through 51, 63 and 64, SEMINOLE LAND AND INVESTMENT COMPANY'S SUBDIVISION of Section 4, Township 27 South, Range 31 East, according to the plat thereof, as recorded in Plat Book B, Page 30 of the Public Records of Osceola County, Florida, being more particularly described as follows:

Commence at the North $\frac{1}{4}$ corner of Section 4, Township 27 South, Range 31 East, Osceola County, Florida; thence S00°03'15"E, a distance of 30.00 feet to a point on the South Right of Way line of Hickory Tree Road, said point also being the Point of Beginning; thence the following four (4) courses and distances along said South Right of Way line: thence N89°28'01"E, a distance of 111.20 feet; thence N89°44'31"E, a distance of 18.43 feet; thence N00°15'29"W, a distance of 10.00 feet; thence N89°44'31"E, a distance of 1,763.26 feet; thence departing said South Right of Way line, run S00°28'07"E, a distance of 228.96 feet; thence S89°31'53"W, a distance of 22.96 feet; thence S00°32'00"E, a distance of 523.00 feet; thence S89°31'53"W, a distance of 120.00 feet; thence S00°32'00"E, a distance of 762.00 feet; thence S89°31'53"W, a distance of 442.15 feet; thence S00°00'13"W, a distance of 295.01 feet; thence N89°31'53"E, a distance of 414.92 feet; thence N00°28'07"W, a distance of 120.00 feet; thence N89°31'53"E, a distance of 30.00 feet; thence S00°28'07"E, a distance of 120.00 feet; thence N89°31'53"E, a distance of 409.91 feet; thence S00°32'00"E, a distance of 202.52 feet to the Point of Curvature of a curve, Concave to the West, having a Radius of 50.00 feet and a Central Angle of 35°00'00"; thence run Southerly along the Arc of said curve, a distance of 30.54 feet (Chord Bearing = S16°58'00"W, Chord = 30.07 feet) to a Point of Tangency; thence S34°28'00"W, a distance of 385.25 feet to the Point of Curvature of a curve, Concave to the Northwest, having a Radius of 50.00 feet and a Central Angle of 55°32'00"; thence run Southwesterly along the Arc of said curve, a distance of 48.46 feet (Chord Bearing = S62°14'00"W, Chord = 46.59 feet) to a Point of Tangency; thence N90°00'00"W, a distance of 477.39 feet to the Point of Curvature of a curve, Concave to the Northeast, having a Radius of 50.00 feet and a Central Angle of 57°23'59"; thence run Northwesterly along the Arc of said curve, a

ABBREVIATIONS/LEGEND

SEC.	SECTION	O.R.B.	OFFICIAL RECORDS BOOK
TWP.	TOWNSHIP	PGS.	PAGES
RNG.	RANGE	P.B.	PLAT BOOK
N.	NORTH	R/W	RIGHT OF WAY
S.	SOUTH	CHD.	CHORD
E.	EAST	NO./#	NUMBER
W.	WEST	●	DESCRIPTIVE POINT

NOTES
 BEARINGS AS SHOWN HEREON ARE BASED ON THE FLORIDA STATE PLANE COORDINATE SYSTEM, EAST ZONE, (NAD 83, 2007 ADJUSTMENT). THIS SURVEYOR HAS NOT MADE A SEARCH OF THE PUBLIC RECORDS FOR EASEMENTS, RESTRICTIONS, RESERVATIONS AND/OR RIGHT OF WAYS. THIS SKETCH IS NOT INTENDED TO REPRESENT A BOUNDARY SURVEY. NO CORNERS WERE SET AS A PART OF THIS SKETCH.

REQUESTED BY: **CLAYTON PROPERTIES GROUP**



DATE OF SKETCH	8/24/2023	REVISIONS	 900 Cross Prairie Parkway, Kissimmee, Florida 34744 Tel. (407) 847-2179 Fax (407) 847-6140  8/28/2023 RICHARD D. BROWN, P.S.M #5700 (DATE) <small>NOTE: NOT VALID WITHOUT RAISED SURVEYOR'S SEAL.</small>
SCALE	1" = 500'/200'		
F.B.	PAGE		
SECTION	4		
TWP.	27 S., RNG. 31 E.		
JOB NO.	21-094		

EXHIBIT 2A LEGAL DESCRIPTION HICKORY TREE CDD PHASES 1 & 2A



SKETCH OF DESCRIPTION

LEGAL DESCRIPTION (continued)

distance of 50.09 feet (Chord Bearing = N61°18'00"W, Chord = 48.02 feet) to a Point of Tangency; thence N32°36'01"W, a distance of 164.56 feet to the Point of Curvature of a curve, Concave to the Southwest, having a Radius of 245.00 feet and a Central Angle of 10°13'25"; thence run Northwesterly along the Arc of said curve, a distance of 43.72 feet (Chord Bearing = N37°42'43"W, Chord = 43.66 feet) to a Point of Non Tangency; thence N42°52'14"W, a distance of 254.23 feet; thence N01°16'58"E, a distance of 179.33 feet; thence N00°25'31"W, a distance of 120.00 feet; thence N89°31'53"E, a distance of 30.00 feet; thence S00°28'07"E, a distance of 120.00 feet; thence N89°31'53"E, a distance of 185.08 feet; thence N00°00'13"E, a distance of 295.01 feet; thence S89°31'53"W, a distance of 139.35 feet; thence N00°28'07"W, a distance of 100.00 feet; thence S87°07'14"W, a distance of 64.06 feet; thence S00°28'07"E, a distance of 97.31 feet; thence S89°31'53"W, a distance of 514.50 feet; thence S00°32'00"E, a distance of 100.03 feet; thence S89°21'26"W, a distance of 57.00 feet; thence S00°32'00"E, a distance of 6.23 feet; thence S89°28'00"W, a distance of 120.00 feet; thence N13°29'44"W, a distance of 124.35 feet; thence S77°24'23"W, a distance of 19.10 feet; thence N32°12'54"W, a distance of 59.70 feet; thence N84°31'17"W, a distance of 78.06 feet; thence N00°03'31"E, a distance of 85.38 feet; thence N27°16'38"E, a distance of 59.34 feet; thence N00°32'00"W, a distance of 465.71 feet to a Point on a Non-Tangent Curve, Concave to the Southwest, having a Radius of 25.09 feet and a Central Angle of 89°30'52"; thence run Northwesterly along the arc of said curve, a distance of 39.20 feet (Chord Bearing = N45°30'03"W, Chord = 35.34 feet) to a Point of Non Tangency; thence S89°31'53"W, a distance of 565.00 feet; thence N86°16'03"W, a distance of 107.33 feet; thence S89°31'53"W, a distance of 455.02 feet; thence N00°32'17"W, a distance of 243.60 feet; thence S89°28'29"W, a distance of 413.97 feet to a point on the East Right of Way line of Lake Gentry Road; thence N00°50'25"W, along said East Right of Way line, a distance of 562.96 feet to a point on the South Right of Way line of Hickory Tree Road; thence the following two (2) courses and distances along said South Right of Way line: thence N89°53'31"E, a distance of 414.69 feet; thence N89°28'01"E, a distance of 868.66 feet to the Point of Beginning.

Containing 91.94 acres, more or less.

JOHNSTON'S
SURVEYING INC.
900 Cross Prairie Parkway, Kissimmee, Florida 34744
Tel. (407) 847-2179 Fax (407) 847-6140



**EXHIBIT 2A
LEGAL DESCRIPTION
HICKORY TREE CDD
PHASES 1 & 2A**

SHEET 2 OF 7

SKETCH OF DESCRIPTION

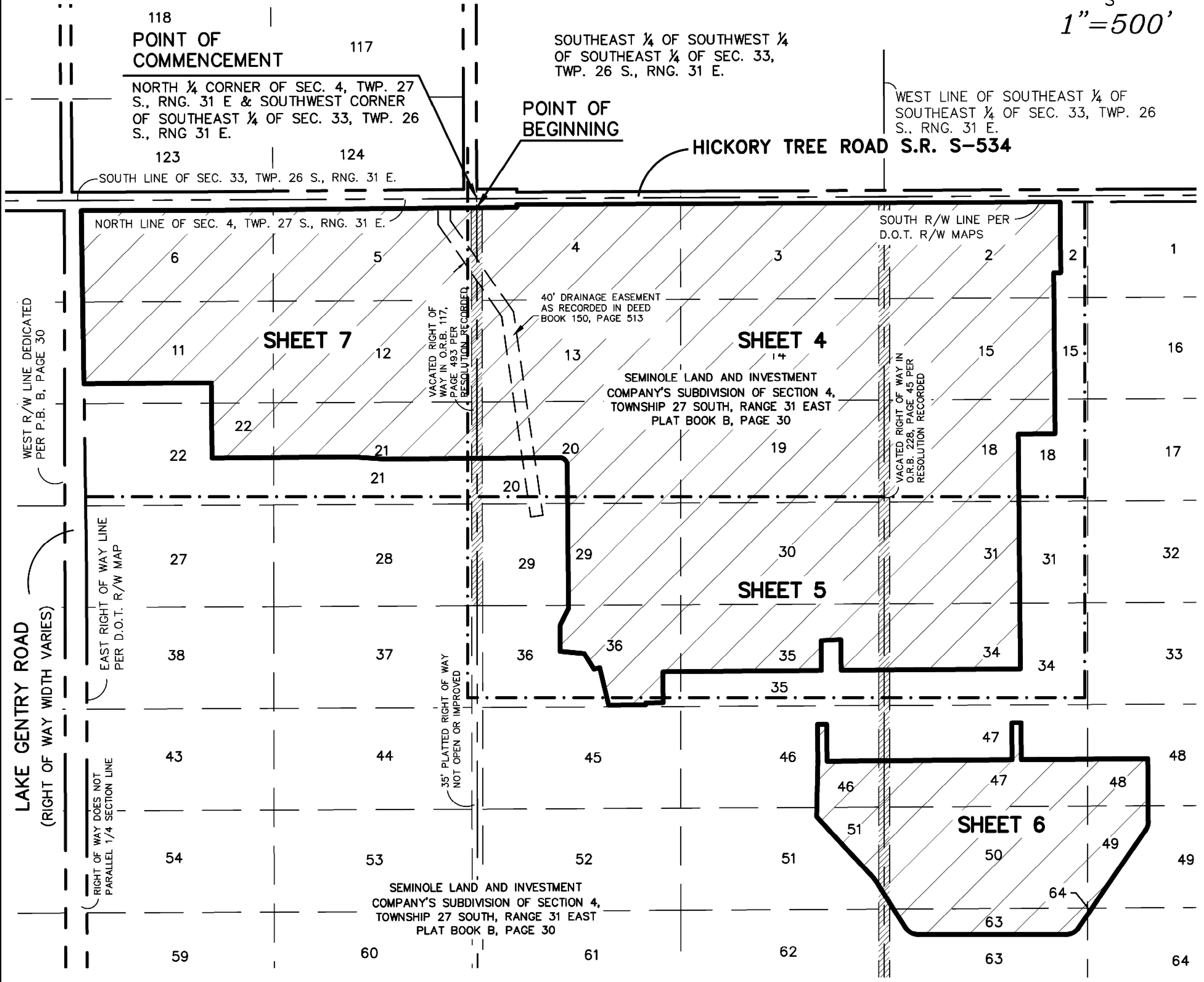
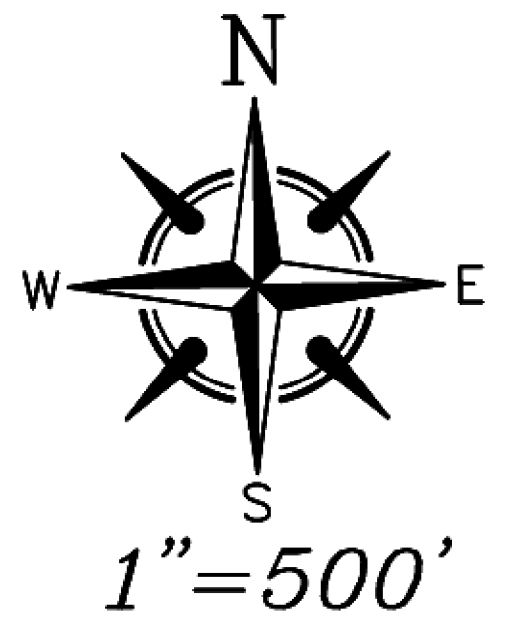

JOHNSTON'S
SURVEYING INC.
 900 Cross Prairie Parkway, Kissimmee, Florida 34744
 Tel. (407) 847-2179 Fax (407) 847-6140

EXHIBIT 2A
LEGAL DESCRIPTION
HICKORY TREE CDD
PHASES 1 & 2A



SKETCH OF DESCRIPTION

POINT OF COMMENCEMENT

NORTH 1/4 CORNER OF SEC. 4,
TWP. 27 S., RNG. 31 E
& SOUTHWEST CORNER OF
SOUTHEAST 1/4 OF SEC. 33,
TWP. 26 S., RNG. 31 E.

RIGHT OF WAY DOES NOT
PARALLEL SECTION LINE

SOUTH R/W LINE PER
D.O.T. R/W MAPS

HICKORY TREE ROAD
S.R. S-534

VACATED RIGHT OF WAY
PER RESOLUTION RECORDED
IN O.R.B. 117, PAGE 493

40' DRAINAGE EASEMENT
AS RECORDED IN DEED
BOOK 150, PAGE 513

SEMINOLE LAND AND
INVESTMENT COMPANY'S
SUBDIVISION OF SECTION 4,
TOWNSHIP 27 SOUTH, RANGE 31
EAST PLAT BOOK B, PAGE 30

VACATED RIGHT OF WAY
PER RESOLUTION RECORDED
IN O.R.B. 228, PAGE 45

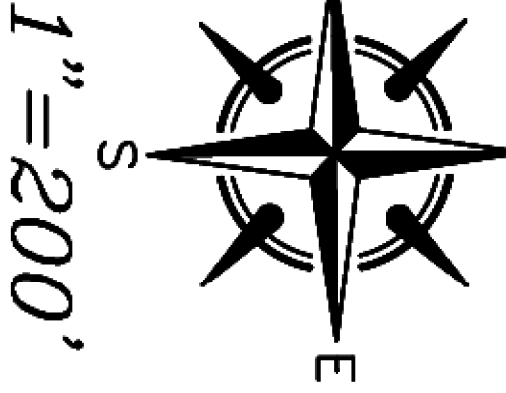
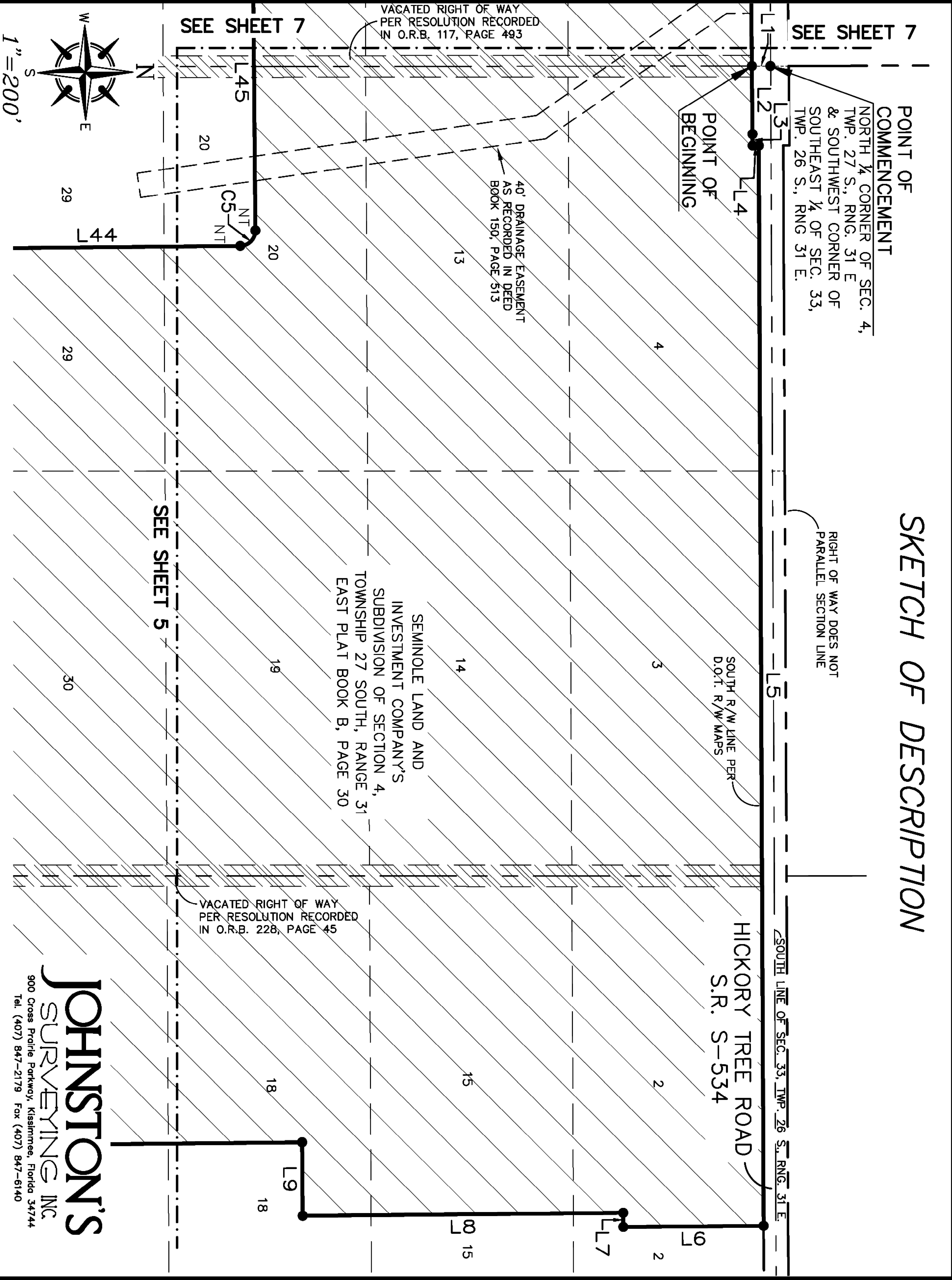

EXHIBIT 2A
LEGAL DESCRIPTION
HICKORY TREE CDD
PHASES 1 & 2A

JOHNSTON'S
SURVEYING INC.
900 Cross Prairie Parkway, Kissimmee, Florida 34744
Tel. (407) 847-2179 Fax (407) 847-6140



SKETCH OF DESCRIPTION

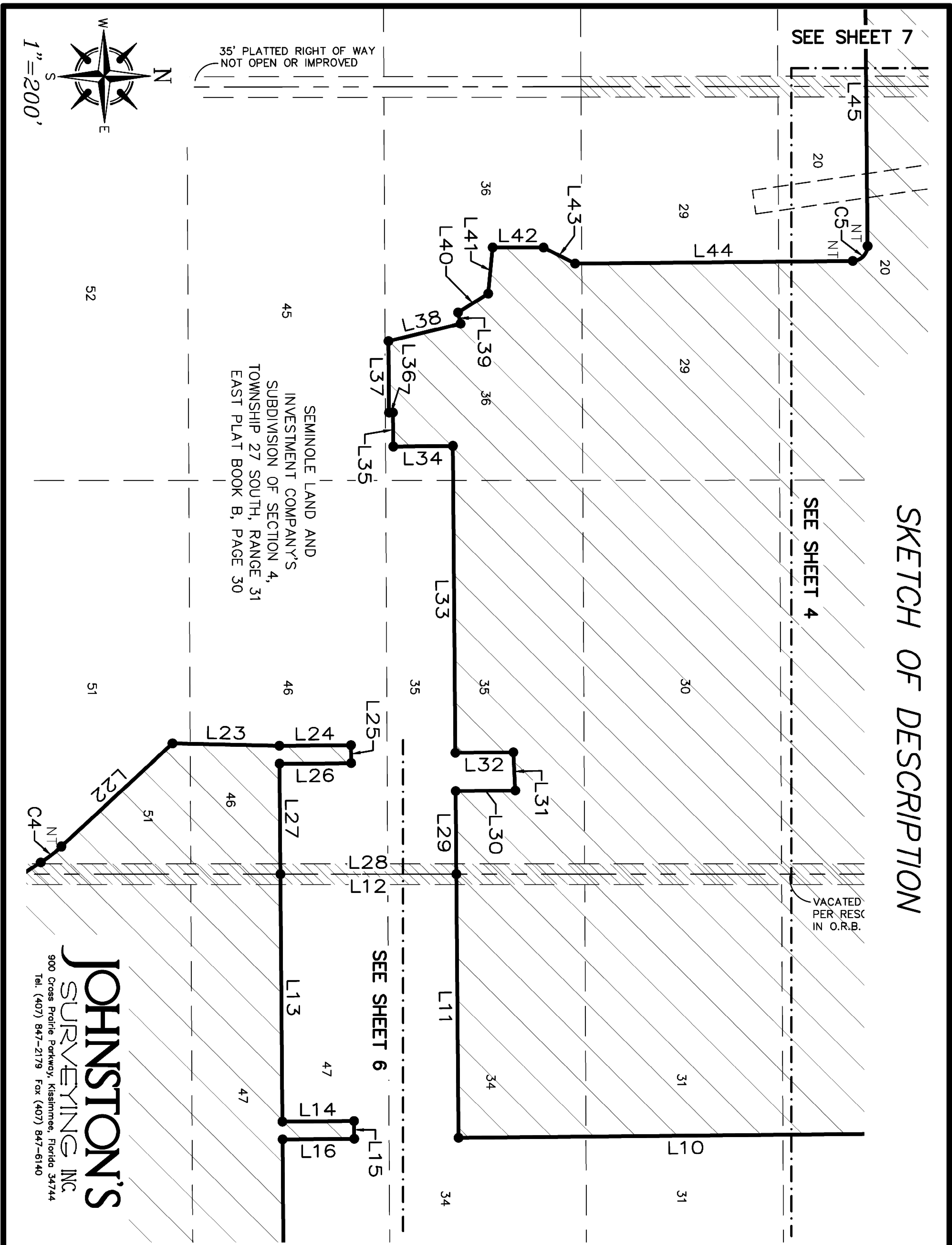

EXHIBIT 2A
 LEGAL DESCRIPTION
 HICKORY TREE CDD
 PHASES 1 & 2A

JOHNSTON'S
 SURVEYING INC.
 900 Cross Prairie Parkway, Kissimmee, Florida 34744
 Tel. (407) 847-2179 Fax (407) 847-6140



SKETCH OF DESCRIPTION

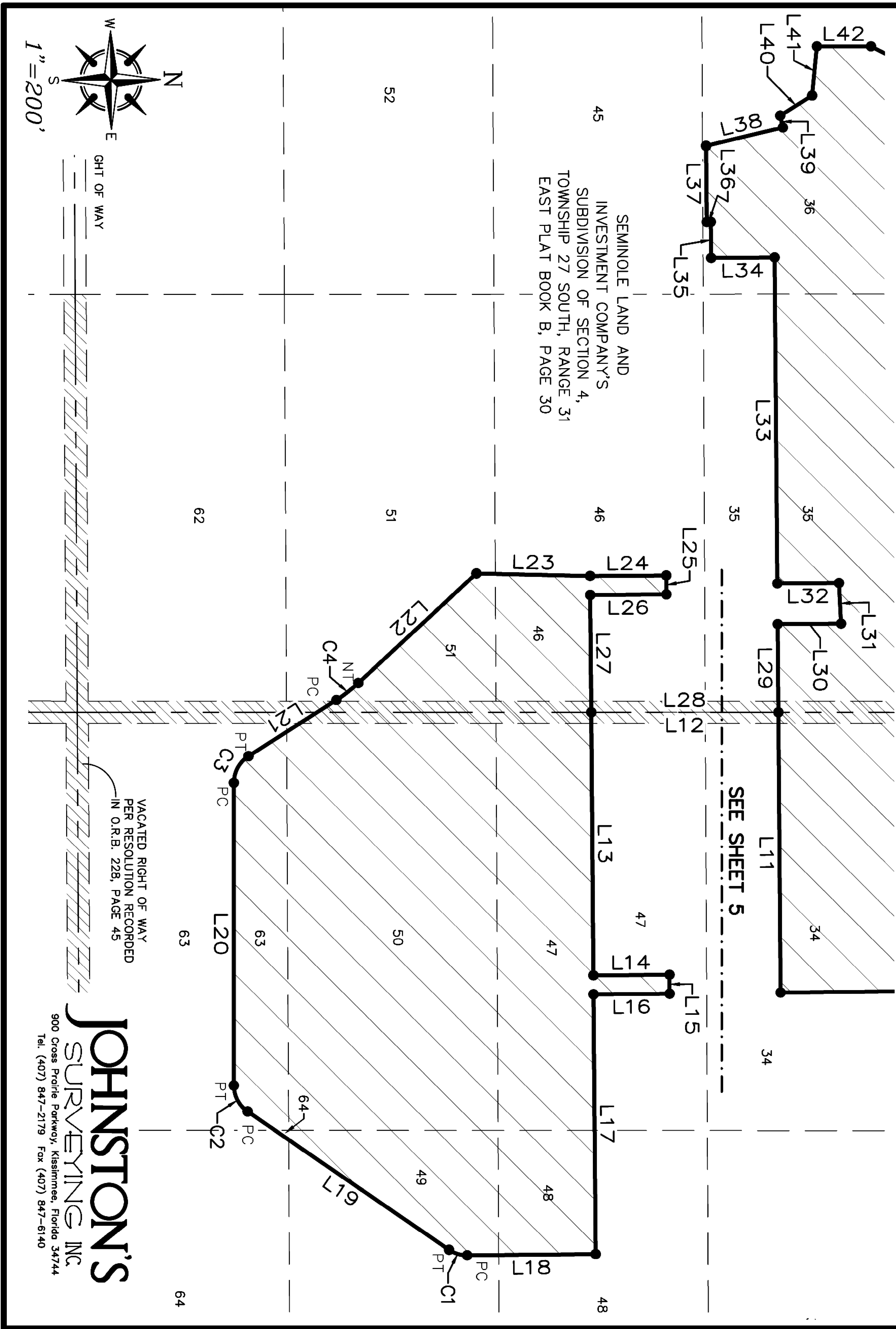
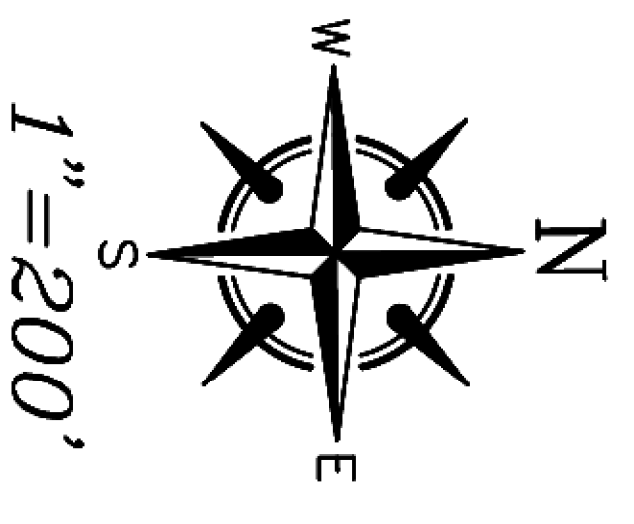

EXHIBIT 2A
 LEGAL DESCRIPTION
 HICKORY TREE CDD
 PHASES 1 & 2A

VACATED RIGHT OF WAY
 PER RESOLUTION RECORDED
 IN O.R.B. 228, PAGE 45



GHT OF WAY

SKETCH OF DESCRIPTION

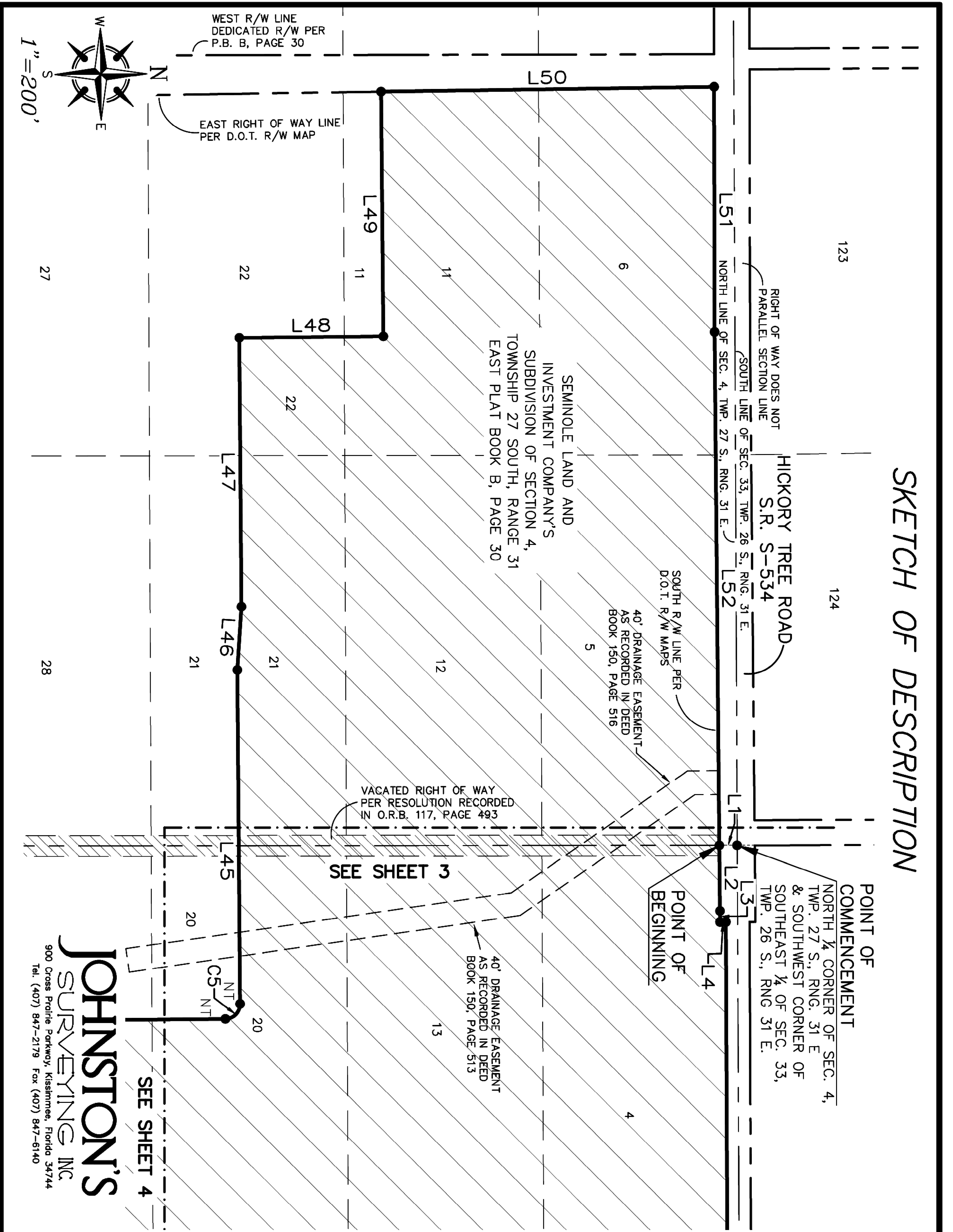

JOHNSTON'S
SURVEYING INC.
900 Cross Prairie Parkway, Kissimmee, Florida 34744
Tel. (407) 847-2179 Fax (407) 847-6140

**EXHIBIT 2A
LEGAL DESCRIPTION
HICKORY TREE CDD
PHASES 1 & 2A**

SKETCH OF DESCRIPTION

LEGAL DESCRIPTION

A parcel of land being all of Lots 1, 16, 17, 32, 33, 45, 52, 62, 65, 66 and 67 and a portion of Lots 2, 11, 15, 18, 20, 21, 22, 29, 31, 34, 35, 36, 46 through 51, 63 and 64, SEMINOLE LAND AND INVESTMENT COMPANY'S SUBDIVISION of Section 4, Township 27 South, Range 31 East, according to the plat thereof, as recorded in Plat Book B, Page 30 of the Public Records of Osceola County, Florida, being more particularly described as follows:

Commence at the North $\frac{1}{4}$ corner of Section 4, Township 27 South, Range 31 East, Osceola County, Florida; thence $S00^{\circ}03'15''E$, a distance of 30.00 feet to a point on the South Right of Way line of Hickory Tree Road; thence the following nine (9) courses and distances along said South Right of Way line: thence $N89^{\circ}28'01''E$, a distance of 111.20 feet; thence $N89^{\circ}44'31''E$, a distance of 18.43 feet; thence $N00^{\circ}15'29''W$, a distance of 10.00 feet; thence $N89^{\circ}44'31''E$, a distance of 1,763.26 feet to the Point of Beginning; thence continue $N89^{\circ}44'31''E$, a distance of 533.16 feet to the Point of Curvature of a curve concave to the North, having a Radius of 430.27 feet and a Central Angle of $14^{\circ}28'10''$; thence run Easterly along the Arc of said curve, a distance of 108.66 feet (Chord Bearing = $N82^{\circ}30'26''E$, Chord = 108.37 feet) to a Point of Non Tangency; thence $S14^{\circ}43'39''E$, a distance of 10.00 feet to a Point on a Non-Tangent Curve, Concave to the North, having a Radius of 440.27 feet and a Central Angle of $15^{\circ}08'15''$; thence run Easterly along the arc of said curve, a distance of 116.32 feet (Chord Bearing = $N67^{\circ}42'14''E$, Chord = 115.98 feet) to a Point of Non Tangency; thence departing said South Right of Way line, run $S00^{\circ}08'19''E$, a distance of 27.51 feet to the Northeast corner of Section 4, Township 27 South, Range 31 East; thence the following two (2) courses and distances along the East line of said Section 4: thence $S00^{\circ}03'41''W$, a distance of 2,640.95 feet; thence $S00^{\circ}03'22''W$, a distance of 329.93 feet; thence departing said East line, run $S89^{\circ}43'07''W$, a distance of 1,978.72 feet; thence $N00^{\circ}05'05''E$, a distance of 329.55 feet; thence $N00^{\circ}01'31''W$, a distance of 330.28 feet; thence $S89^{\circ}42'42''W$, a distance of 642.18 feet; thence $N00^{\circ}03'15''W$, a distance of 990.89 feet; thence $S89^{\circ}43'25''W$, a distance of 17.50 feet; thence $S89^{\circ}45'06''W$, a distance of 1,267.28 feet to a point on the East Right of Way line of Lake Gentry Road; thence the following two (2) courses and distances along said East Right of Way line: thence $N00^{\circ}04'25''W$, a distance of 120.95 feet; thence $N00^{\circ}50'25''W$,

ABBREVIATIONS/LEGEND

SEC.	SECTION	O.R.B.	OFFICIAL RECORDS BOOK
TWP.	TOWNSHIP	PGS.	PAGES
RNG.	RANGE	P.B.	PLAT BOOK
N.	NORTH	R/W	RIGHT OF WAY
S.	SOUTH	CHD.	CHORD
E.	EAST	NO./#	NUMBER
W.	WEST	●	DESCRIPTIVE POINT

NOTES

BEARINGS AS SHOWN HEREON ARE BASED ON THE FLORIDA STATE PLANE COORDINATE SYSTEM, EAST ZONE, (NAD 83, 2007 ADJUSTMENT). THIS SURVEYOR HAS NOT MADE A SEARCH OF THE PUBLIC RECORDS FOR EASEMENTS, RESTRICTIONS, RESERVATIONS AND/OR RIGHT OF WAYS. THIS SKETCH IS NOT INTENDED TO REPRESENT A BOUNDARY SURVEY. NO CORNERS WERE SET AS A PART OF THIS SKETCH.

REQUESTED BY: **CLAYTON PROPERTIES GROUP**

DATE OF SKETCH	8/25/2023	REVISIONS	 <p>900 Cross Prairie Parkway, Kissimmee, Florida 34744 Tel. (407) 847-2179 Fax (407) 847-6140</p> <p><i>R.D.B.</i> 8/28/2023</p> <p>RICHARD D. BROWN, P.S.M #5700 (DATE)</p> <p><small>NOTE: NOT VALID WITHOUT RAISED SURVEYOR'S SEAL.</small></p>
SCALE	1" = 500'/200'		
F.B.	PAGE		
SECTION	4		
TWP.	27 S., RNG. 31 E.		
JOB NO.	21-094		

EXHIBIT 2B LEGAL DESCRIPTION HICKORY TREE CDD PHASES 2B & 3



SKETCH OF DESCRIPTION

LEGAL DESCRIPTION (continued)

a distance of 603.62 feet; thence departing said East Right of Way line, run N89°28'29"E, a distance of 413.97 feet; thence S00°32'17"E, a distance of 243.60 feet; thence N89°31'53"E, a distance of 455.02 feet; thence S86°16'03"E, a distance of 107.33 feet; thence N89°31'53"E, a distance of 565.00 feet to a Point on a Non-Tangent Curve, Concave to the Southwest, having a Radius of 25.09 feet and a Central Angle of 89°30'52"; thence run Southeasterly along the arc of said curve, a distance of 39.20 feet (Chord Bearing = S45°30'03"E, Chord = 35.34 feet) to a Point of Non Tangency; thence S00°32'00"E, a distance of 465.71 feet; thence S27°16'38"W, a distance of 59.34 feet; thence S00°03'31"W, a distance of 85.38 feet; thence S84°31'17"E, a distance of 78.06 feet; thence S32°12'54"E, a distance of 59.70 feet; thence N77°24'23"E, a distance of 19.10 feet; thence S13°29'44"E, a distance of 124.35 feet; thence N89°28'00"E, a distance of 120.00 feet; thence N00°32'00"W, a distance of 6.23 feet; thence N89°21'26"E, a distance of 57.00 feet; thence N00°32'00"W, a distance of 100.03 feet; thence N89°31'53"E, a distance of 514.50 feet; thence N00°28'07"W, a distance of 97.31 feet; thence N87°07'14"E, a distance of 64.06 feet; thence S00°28'07"E, a distance of 100.00 feet; thence N89°31'53"E, a distance of 139.35 feet; thence S00°00'13"W, a distance of 295.01 feet; thence N89°31'53"E, a distance of 414.92 feet; thence N00°28'07"W, a distance of 120.00 feet; thence N89°31'53"E, a distance of 30.00 feet; thence S00°28'07"E, a distance of 120.00 feet; thence N89°31'53"E, a distance of 409.91 feet; thence S00°32'00"E, a distance of 202.52 feet to the Point of Curvature of a curve, Concave to the West, having a Radius of 50.00 feet and a Central Angle of 35°00'00"; thence run Southerly along the Arc of said curve, a distance of 30.54 feet (Chord Bearing = S16°58'00"W, Chord = 30.07 feet) to a Point of Tangency; thence S34°28'00"W, a distance of 385.25 feet to the Point of Curvature of a curve, Concave to the Northwest, having a Radius of 50.00 feet and a Central Angle of 55°32'00"; thence run Southwesterly along the Arc of said curve, a distance of 48.46 feet (Chord Bearing = S62°14'00"W, Chord = 46.59 feet) to a Point of Tangency; thence N90°00'00"W, a distance of 477.39 feet to the Point of Curvature of a curve, Concave to the Northeast, having a Radius of 50.00 feet and a Central Angle of 57°23'59"; thence run Northwesterly along the Arc of said curve, a distance of 50.09 feet (Chord Bearing = N61°18'00"W, Chord = 48.02 feet) to a Point of Tangency; thence N32°36'01"W, a distance of 164.56 feet to the Point of Curvature of a curve, Concave to the Southwest, having a Radius of 245.00 feet and a Central Angle of 10°13'25"; thence run Northwesterly along the Arc of said curve, a distance of 43.72 feet (Chord Bearing = N37°42'43"W, Chord = 43.66 feet) to a Point of Non Tangency; thence N42°52'14"W, a distance of 254.23 feet; thence N01°16'58"E, a distance of 179.33 feet; thence N00°25'31"W, a distance of 120.00 feet; thence N89°31'53"E, a distance of 30.00 feet; thence S00°28'07"E, a distance of 120.00 feet; thence N89°31'53"E, a distance of 185.08 feet; thence N00°00'13"E, a distance of 295.01 feet; thence N89°31'53"E, a distance of 442.15 feet; thence N00°32'00"W, a distance of 762.00 feet; thence N89°31'53"E, a distance of 120.00 feet; thence N00°32'00"W, a distance of 523.00 feet; thence N89°31'53"E, a distance of 22.96 feet; thence N00°28'07"W, a distance of 228.96 feet to the Point of Beginning.

Containing 114.30 acres, more or less.

JOHNSTON'S
SURVEYING INC.
900 Cross Prairie Parkway, Kissimmee, Florida 34744
Tel. (407) 847-2179 Fax (407) 847-6140

EXHIBIT 2B
LEGAL DESCRIPTION
HICKORY TREE CDD
PHASES 2B & 3



SKETCH OF DESCRIPTION

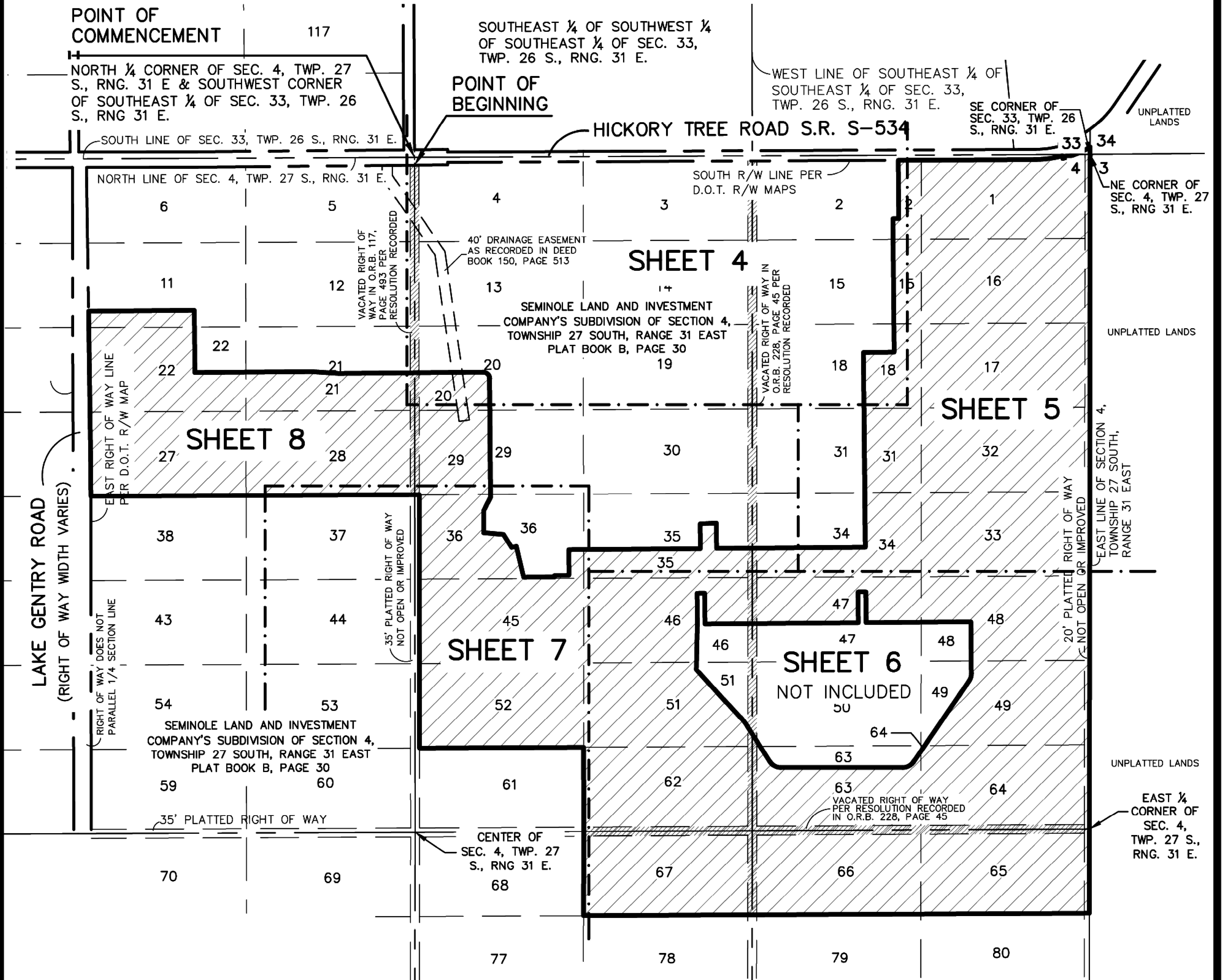
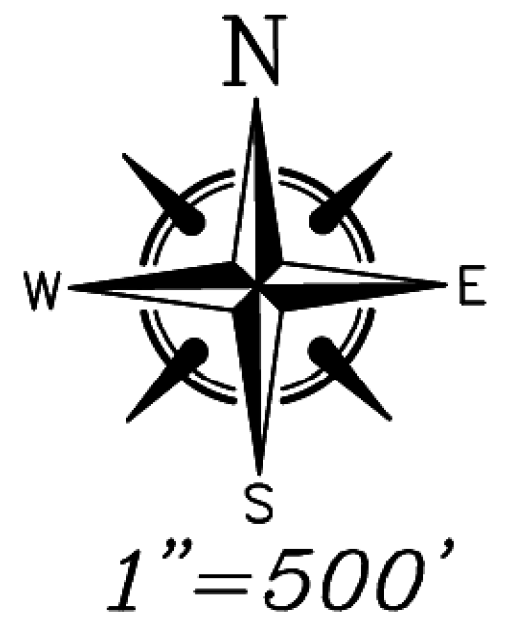

JOHNSTON'S
SURVEYING INC.
900 Cross Prairie Parkway, Kissimmee, Florida 34744
Tel. (407) 847-2179 Fax (407) 847-6140

**EXHIBIT 2B
LEGAL DESCRIPTION
HICKORY TREE CDD
PHASES 2B & 3**



SKETCH OF DESCRIPTION

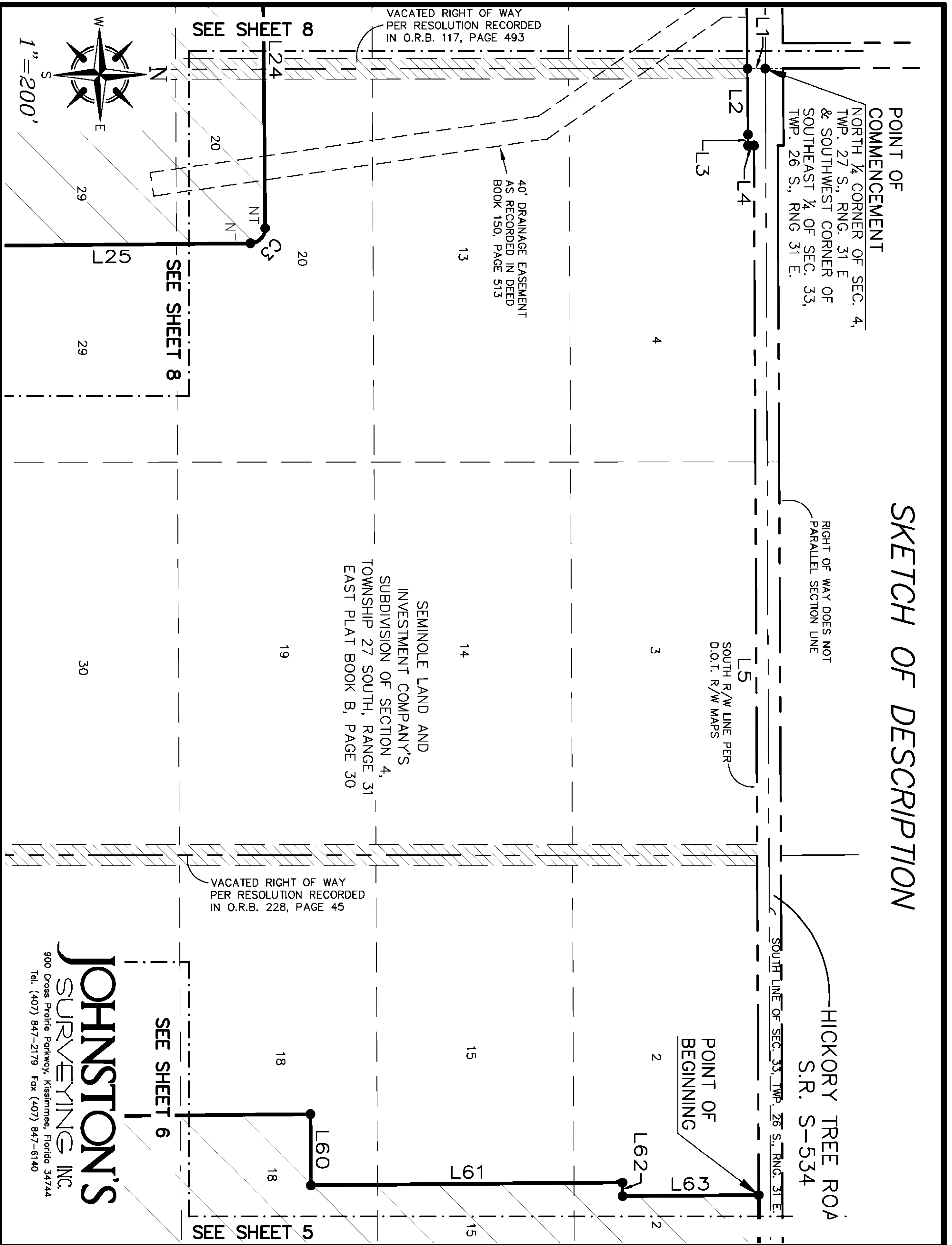

**EXHIBIT 2B
 LEGAL DESCRIPTION
 HICKORY TREE CDD
 PHASES 2B & 3**

JOHNSTON'S
 SURVEYING INC.
 900 Cross Prairie Parkway, Kissimmee, Florida 34744
 Tel. (407) 847-2179 Fax (407) 847-6140

SKETCH OF DESCRIPTION

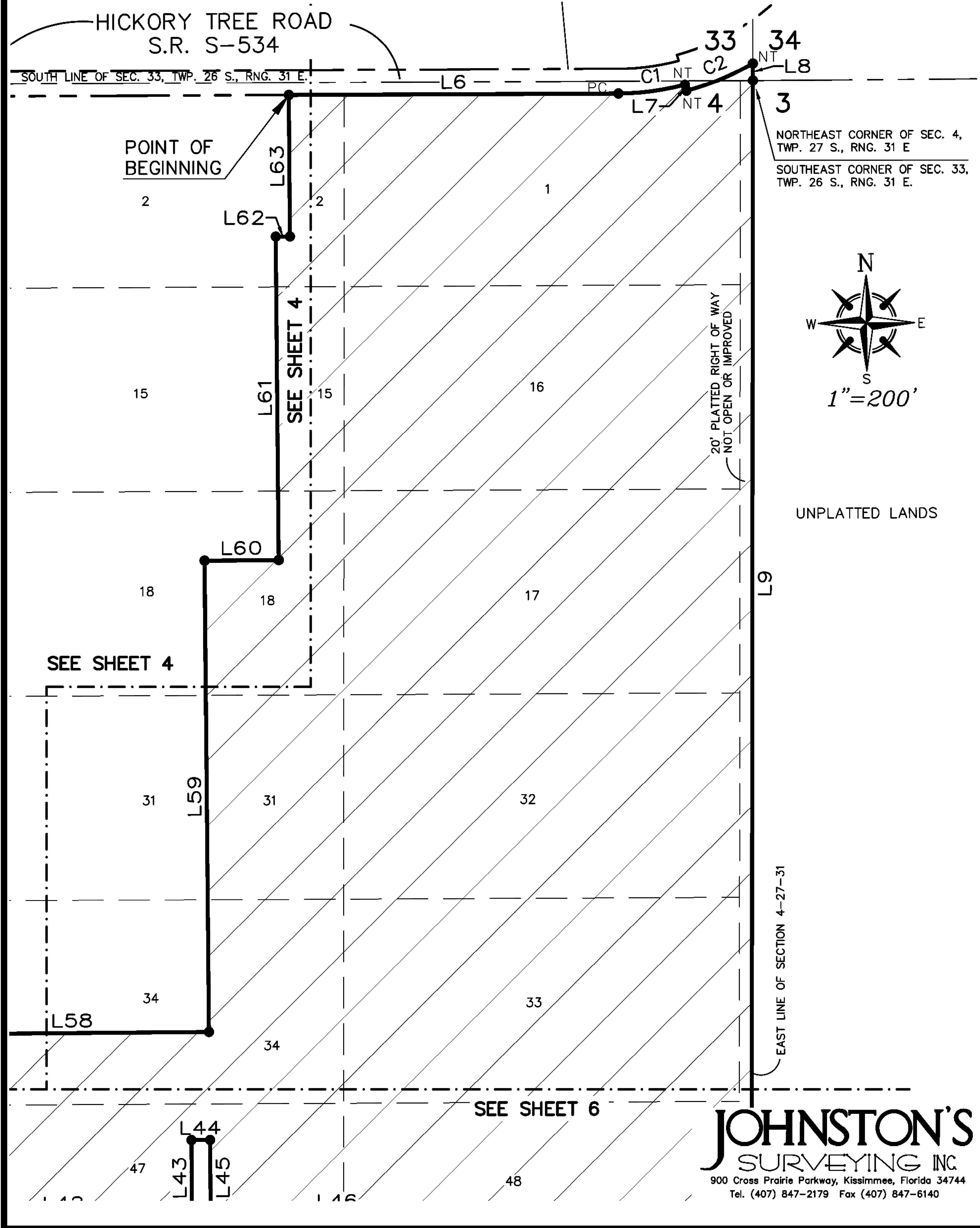

**EXHIBIT 2B
LEGAL DESCRIPTION
HICKORY TREE CDD
PHASES 2B & 3**



SKETCH OF DESCRIPTION

SEE SHEET 5

SEE SHEET 7

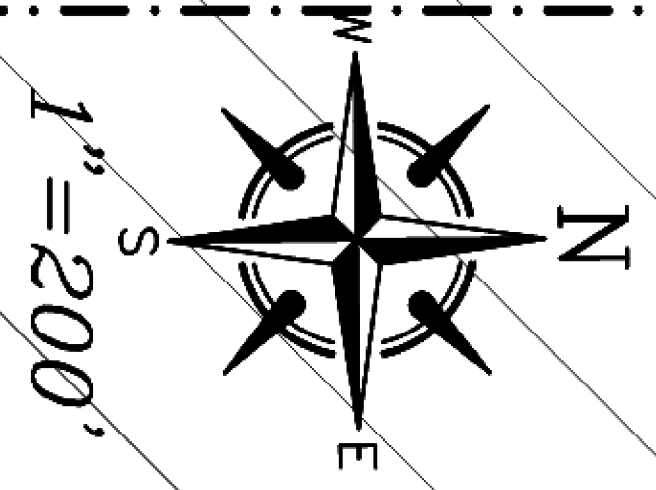

SEMINOLE LAND AND INVESTMENT COMPANY'S SUBDIVISION OF SECTION 4, TOWNSHIP 27 SOUTH, RANGE 31 EAST PLAT BOOK B, PAGE 30

VACATED RIGHT OF WAY PER RESOLUTION RECORDED IN O.R.B. 228, PAGE 45

EAST 1/4 CORNER OF SEC. 4, TWP. 27 S., RNG. 31 E.

20' PLATTED RIGHT OF WAY NOT OPEN OR IMPROVED

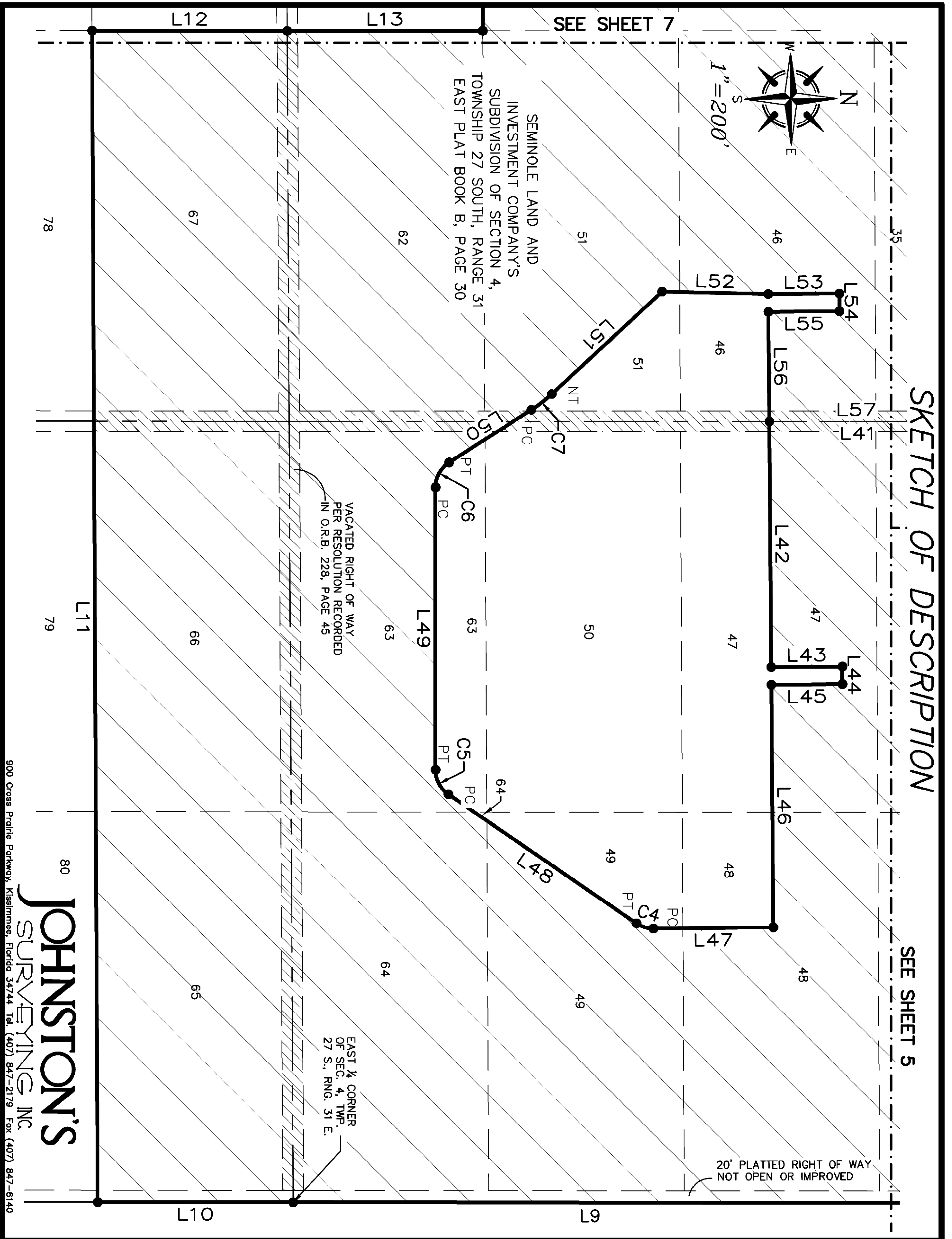
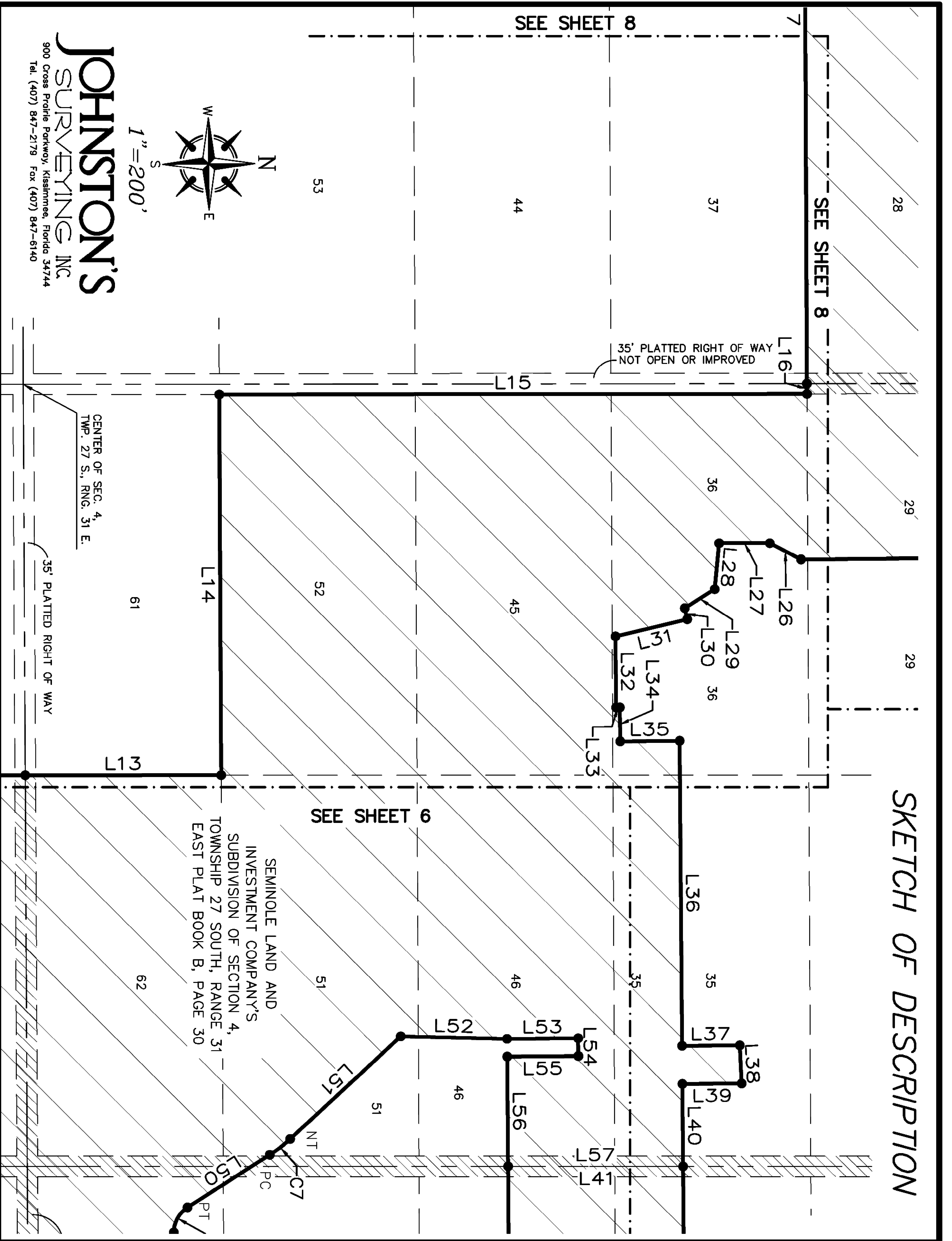

EXHIBIT 2B
LEGAL DESCRIPTION
HICKORY TREE CDD
PHASES 2B & 3

JOHNSTON'S SURVEYING INC.
900 Cross Prairie Parkway, Kissimmee, Florida 34744 Tel: (407) 847-2179 Fax (407) 847-6140



SKETCH OF DESCRIPTION



JOHNSTON'S
SURVEYING, INC.
900 Cross Prairie Parkway, Kissimmee, Florida 34744
Tel: (407) 847-2179 Fax (407) 847-6140

1"=200'

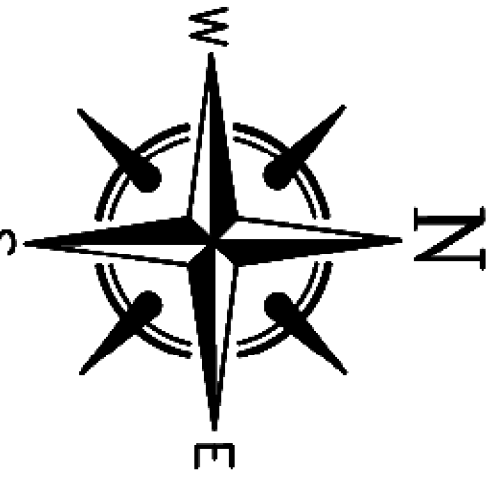
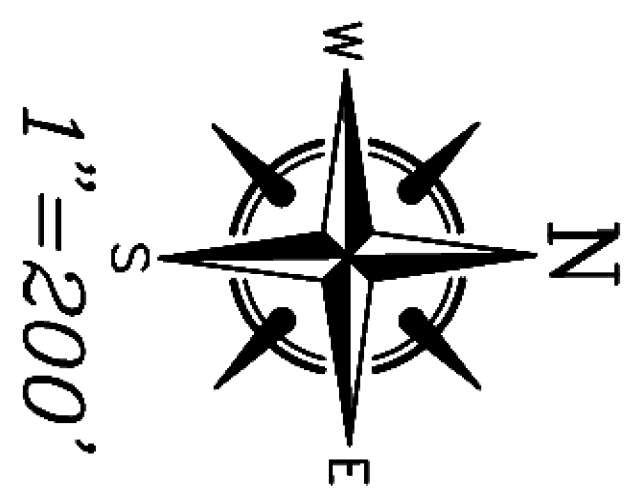

**EXHIBIT 2B
LEGAL DESCRIPTION
HICKORY TREE CDD
PHASES 2B & 3**



SKETCH OF DESCRIPTION

SEE SHEET 8



WEST R/W LINE
DEDICATED R/W PER
P.B. B, PAGE 30

LAKE GENTRY ROAD
(RIGHT OF WAY WIDTH VARIES)

EAST RIGHT OF WAY LINE
PER D.O.T. R/W MAP

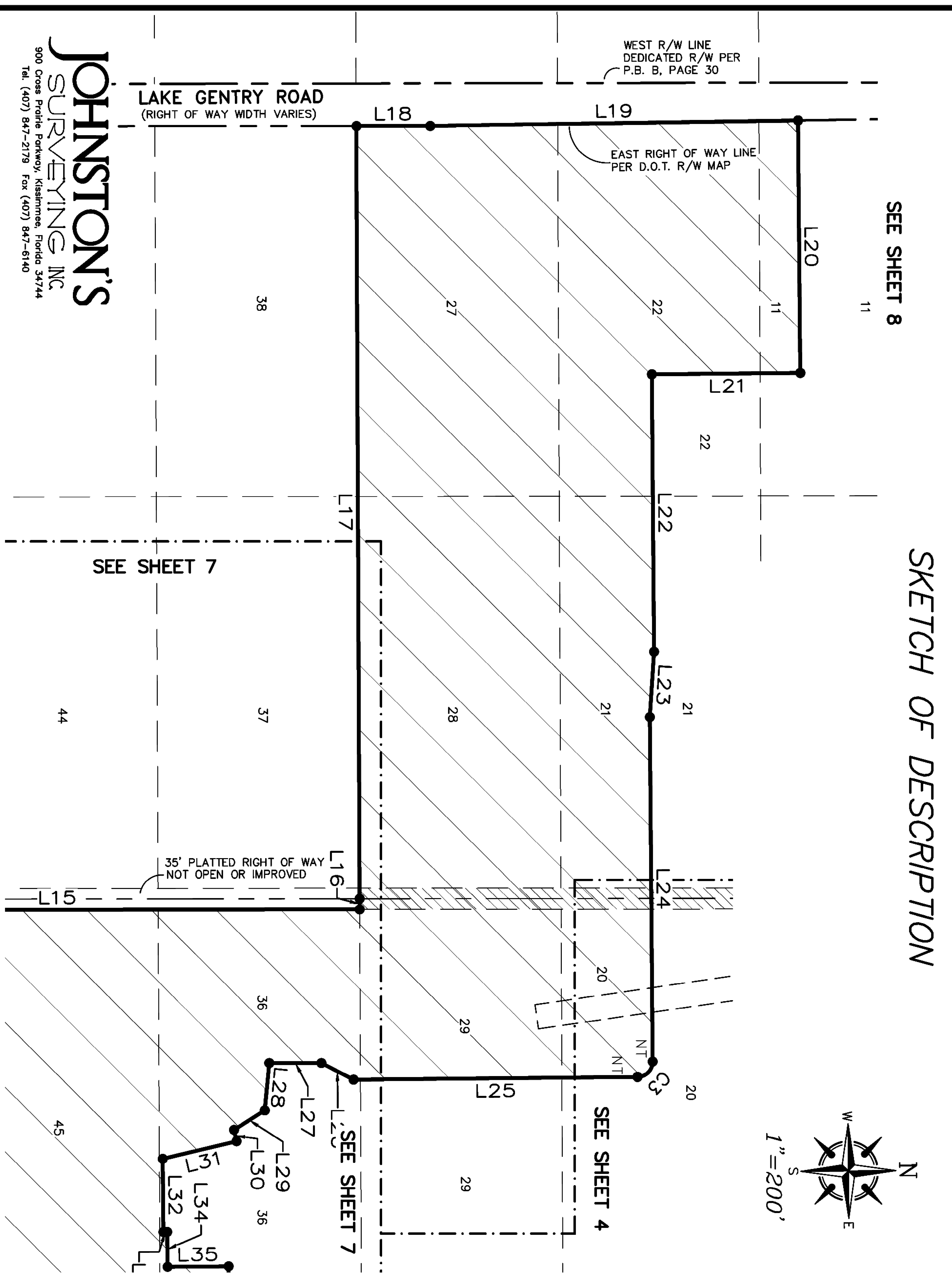

JOHNSTON'S
SURVEYING INC
900 Cross Prairie Parkway, Kissimmee, Florida 34744
Tel. (407) 847-2179 Fax (407) 847-6140

EXHIBIT 2B
LEGAL DESCRIPTION
HICKORY TREE CDD
PHASES 2B & 3



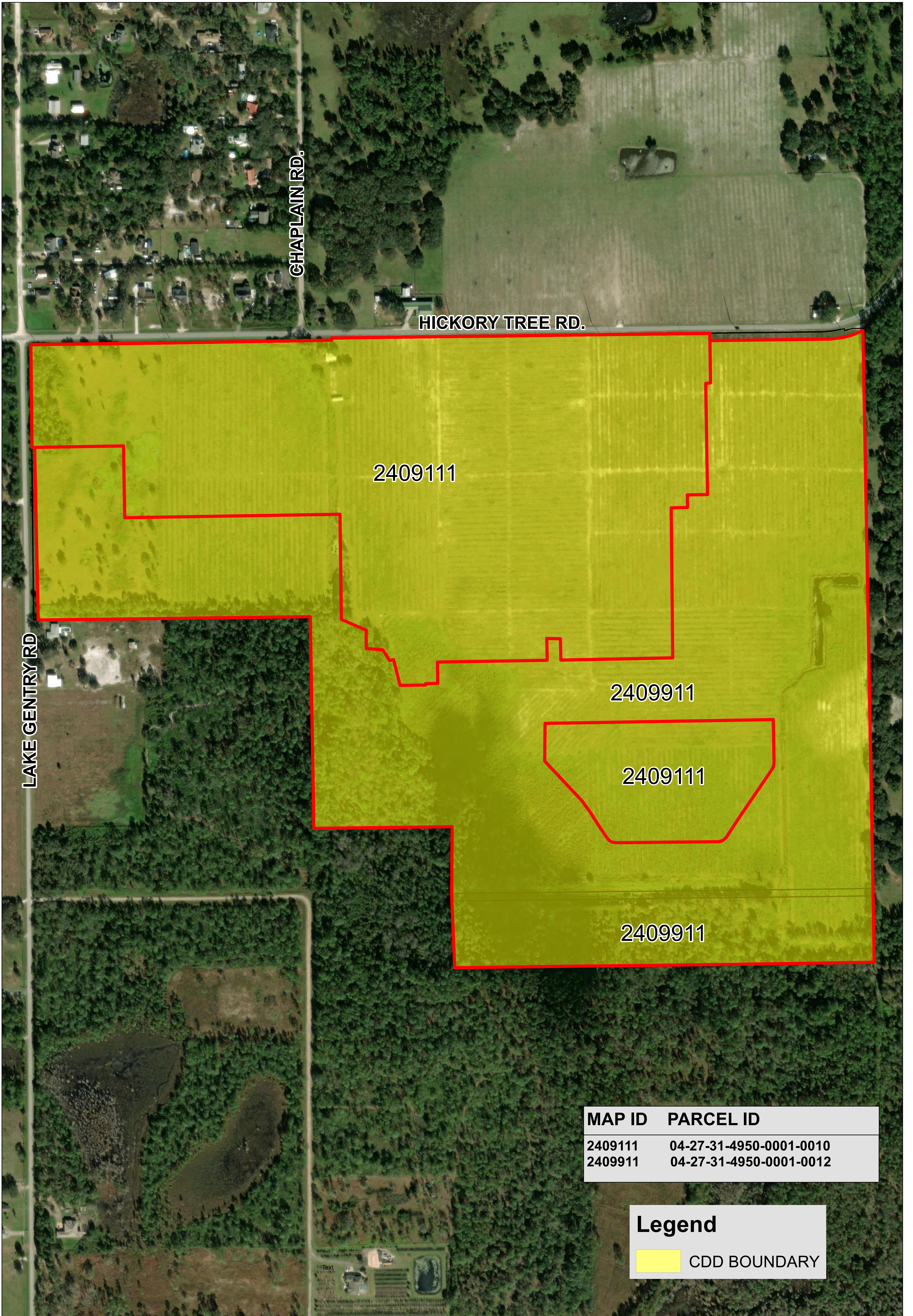

MAP ID	PARCEL ID
2409111	04-27-31-4950-0001-0010
2409911	04-27-31-4950-0001-0012

Legend

CDD BOUNDARY

SECT 4, T27S, R31E

EXHIBIT 3 - BOUNDARY MAP HICKORY TREE CDD

APPROX. CDD BOUNDARY
AREA - 205.00 AC.



0 205 410

Feet

DATE: August 31, 2023

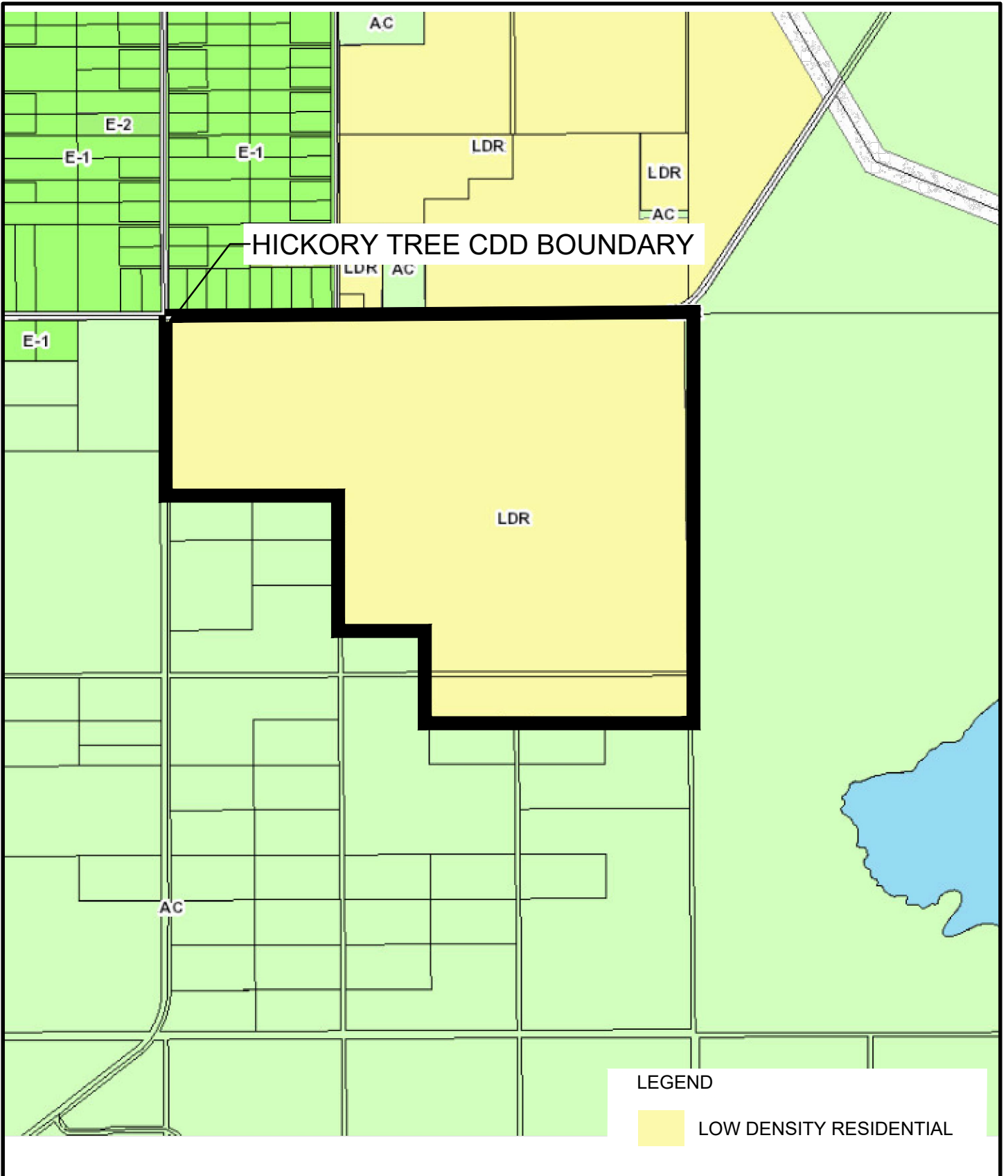

SECT 4, T27S, R31E

APPROX. CDD BOUNDARY
AREA - 205.00 ± AC.

EXHIBITS 4 - ZONING MAP HICKORY TREE CDD

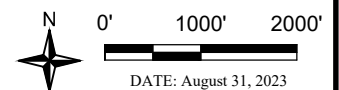

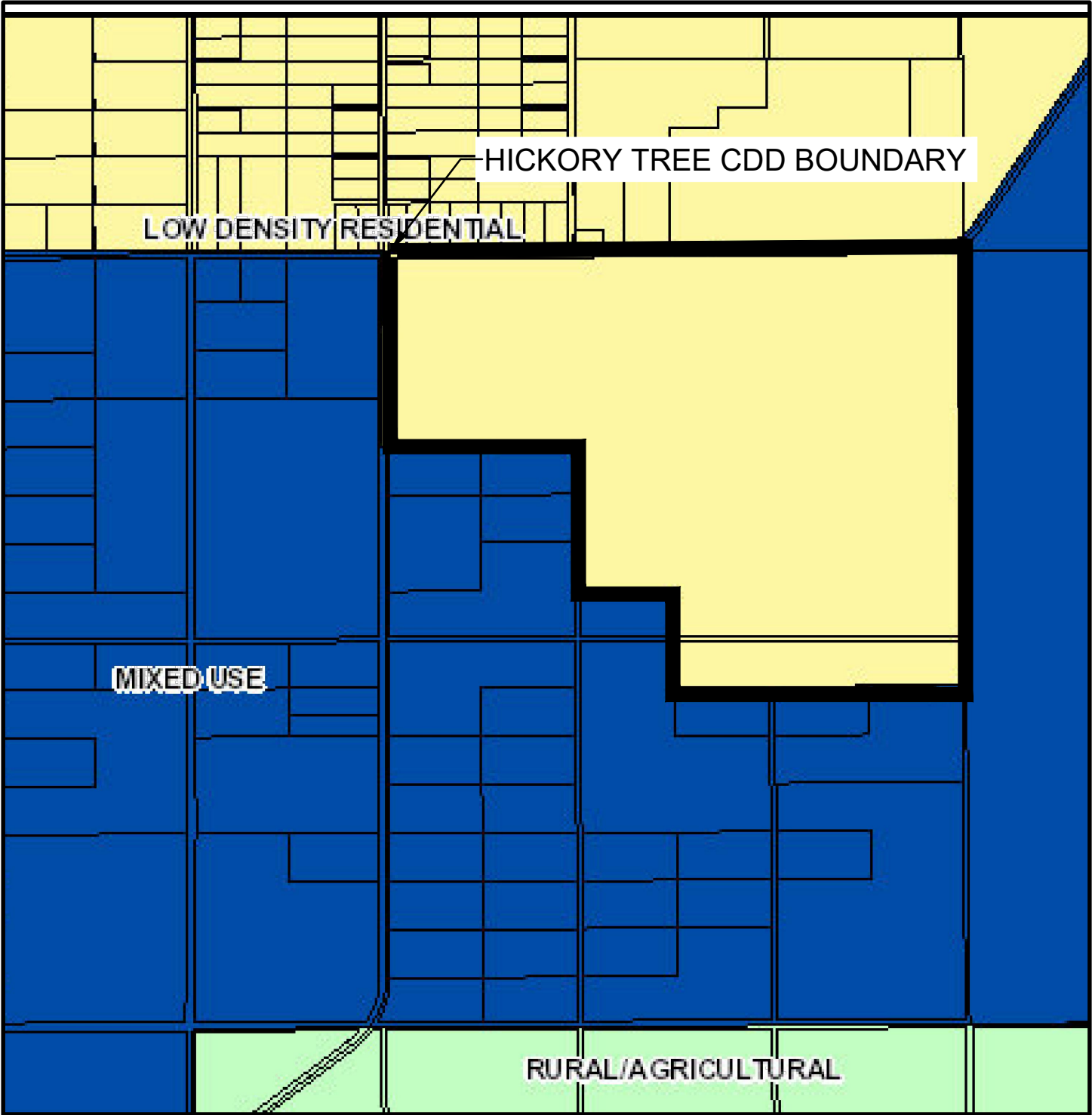

HICKORY TREE CDD BOUNDARY

LOW DENSITY RESIDENTIAL

MIXED USE

RURAL/AGRICULTURAL

LEGEND

 LOW DENSITY RESIDENTIAL

SECT 4, T27S, R31E

**EXHIBIT 5 - FUTURE LAND
USE MAP
HICKORY TREE CDD**

APPROX. CDD BOUNDARY
AREA - 205.00 ± AC.

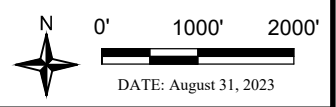

HICKORY TREE ROAD

HICKORY TREE BOUNDARY

HICKORY TREE ROAD

LAKE GENTRY ROAD

AREA OF MINIMAL FLOOD HAZARD
Zone X

OSCEOLA COUNTY
120189

12097C0290G
eff. 6/18/2013

Zone AE
(LL 66 Feet)

SPECIAL FLOOD HAZARD AREAS		Without Base Flood Elevation (BFE) Zone A, V, A99
		With BFE or Depth Zone AE, AO, AH, VE, AR
		Regulatory Floodway
OTHER AREAS OF FLOOD HAZARD		0.2% Annual Chance Flood Hazard, Areas of 1% annual chance flood with average depth less than one foot or with drainage areas of less than one square mile Zone X
		Future Conditions 1% Annual Chance Flood Hazard Zone X
		Area with Reduced Flood Risk due to Levee. See Notes. Zone X
		Area with Flood Risk due to Levee Zone D
OTHER AREAS		NO SCREEN Area of Minimal Flood Hazard Zone X
		Effective LOMRs
GENERAL STRUCTURES		Area of Undetermined Flood Hazard Zone D
		Channel, Culvert, or Storm Sewer
OTHER FEATURES		Levee, Dike, or Floodwall
		Cross Sections with 1% Annual Chance
		Water Surface Elevation
		Coastal Transect
		Base Flood Elevation Line (BFE)
		Limit of Study
		Jurisdiction Boundary
	Coastal Transect Baseline	
	Profile Baseline	
	Hydrographic Feature	

NOTES

1. Water, Reclaim and Sewer to be provided by the City of St. Cloud.
2. Tie-in connection point of utilities are located approximately 1-mile from CDD.

SECT 4, T27S, R31E

EXHIBIT 6 - DRAINAGE AND UTILITIES
HICKORY TREE CDD

APPROX. CDD BOUNDARY
AREA - 205.00 ± AC.

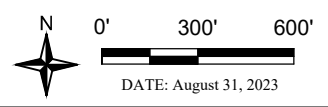

Exhibit 7A

SUMMARY OF PROPOSED DISTRICT FACILITIES				
DISTRICT INFRASTRUCTURE	CONSTRUCTION	OWNERSHIP	CAPITAL FINANCING	OPERATION AND MAINTENANCE
Stormwater Facilities	District	District	District Bonds	District
Lift Stations/Water/Sewer	District	City of St. Cloud	District Bonds	City of St. Cloud
Street Lighting**	District	District	District Bonds	OUC
Onsite Road Construction	District	District	District Bonds	District
Offsite Road Construction	District	Osceola County	District Bonds	Osceola County
Entry Feature & Signage	District	District	District Bonds	District
Recreation Facilities/Amenities	District	District	District Bonds	District

*Costs not funded by bonds will be funded by the developer.

** Only includes the incremental cost of undergrounding the electric conduit.

Exhibit 7B

COST ESTIMATE			
FACILITY TYPE	PHASES 1 & 2A 2023-2025 (406 LOTS)	"PHASES 2B & 3 2024-2027 (391 LOTS)"	TOTAL (797 LOTS)
Offsite Improvements ⁽¹⁾⁽⁵⁾⁽⁷⁾⁽¹¹⁾	\$4,265,923	\$1,711,798	\$5,977,721
Stormwater Management ⁽¹⁾⁽²⁾⁽³⁾⁽⁵⁾⁽⁶⁾⁽⁷⁾	\$9,184,694	\$3,378,436	\$12,563,130
Utilities (Water, Sewer, & Street Lighting) ^{(1) (5)(7) (9) (11)}	\$8,234,070	\$3,028,764	\$11,262,834
Roadway ⁽¹⁾⁽⁴⁾⁽⁵⁾⁽⁷⁾	\$4,104,173	\$1,509,651	\$5,613,824
Entry Feature ⁽¹⁾⁽⁷⁾⁽⁸⁾⁽⁹⁾⁽¹¹⁾	\$250,000	\$250,000	\$500,000
Parks and Amenities ⁽¹⁾⁽⁷⁾⁽¹¹⁾	\$2,500,000	\$1,500,000	
Subtotal	\$28,538,860	\$11,378,649	\$39,917,509
Professional Fees (10%)			\$3,991,751
Subtotal			\$43,909,260
Contingency (10%)			\$4,390,926
Total			\$48,300,186

Notes:

1. Infrastructure consists of public roadway improvements, Stormwater management facilities, master sanitary sewer lift station and utilities, entry feature, landscaping and signage, and public neighborhood parks, all of which will be located on land owned by or subject to a permanent easement in favor of the District or another governmental entity.
2. Excludes grading of each lot in conjunction with home construction, which will be provided by home builder.
3. Includes stormwater pond excavation. Does not include the cost of transportation of fill for use of private lots.
4. Includes sub-grade, base, asphalt paving, curbing, and civil/site engineering.
5. Includes subdivision infrastructure and civil/site engineering.
6. Stormwater does not include grading associated with building pads.
7. Estimates are based on 2023 cost.
8. Includes entry features, signage, hardscape, landscape, irrigation, and fencing.
9. CDD will enter into a Lighting Agreement with OUC for the street light poles and lighting service. Includes only the incremental cost of undergrounding.
10. Estimates based on 797 lots.
11. The costs associated with the infrastructure are a master cost and is effectively shared by the entire project (all phases).

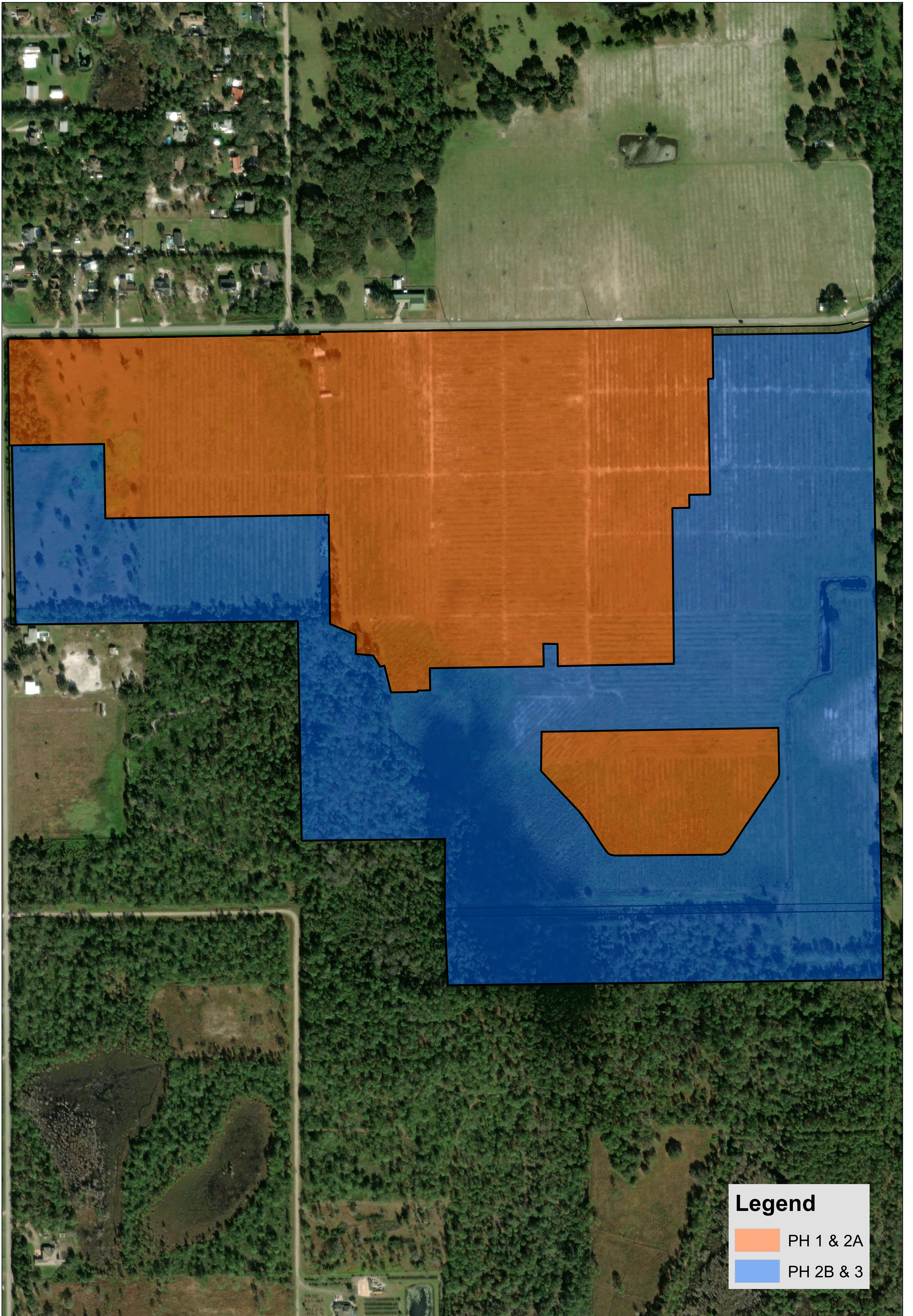

Legend

- PH 1 & 2A
- PH 2B & 3

SECT 4, T27S, R31E

EXHIBIT 8 - PHASING MAP HICKORY TREE CDD

APPROX. CDD BOUNDARY
AREA - 205.00 AC.



0 200 400 Feet
DATE: August 31, 2023

NOTE
ELEVATIONS SHOWN HEREON
ARE BASED ON THE NATIONAL
GEODETIC VERTICAL DATUM
OF 1929

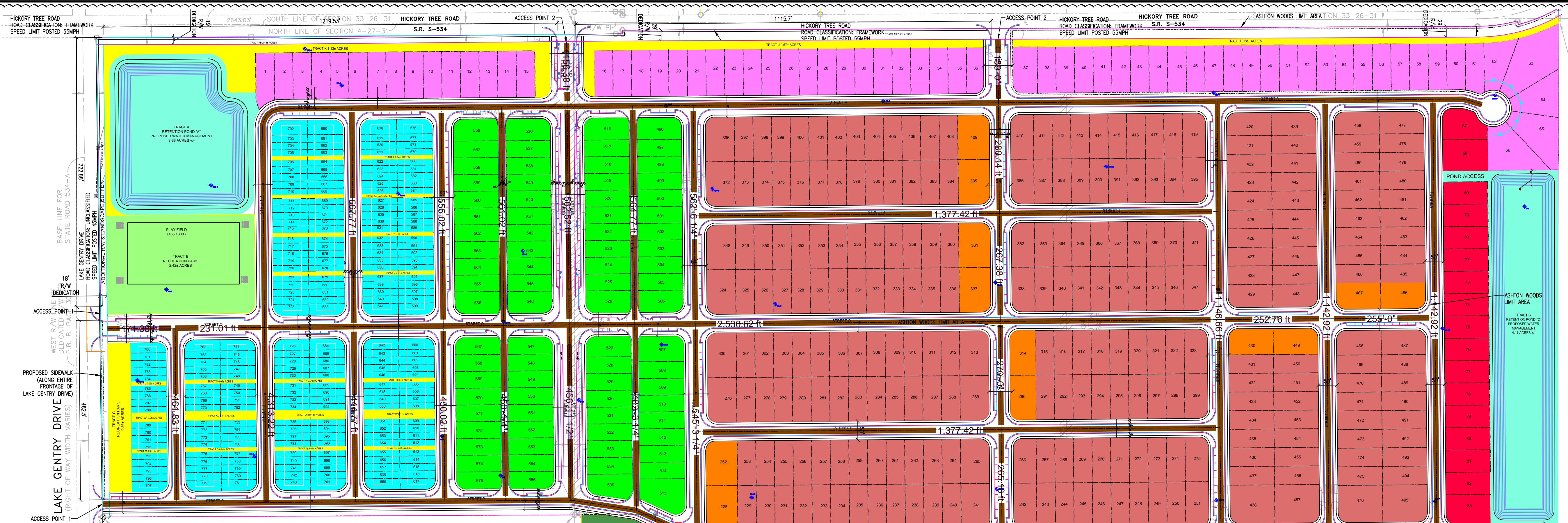
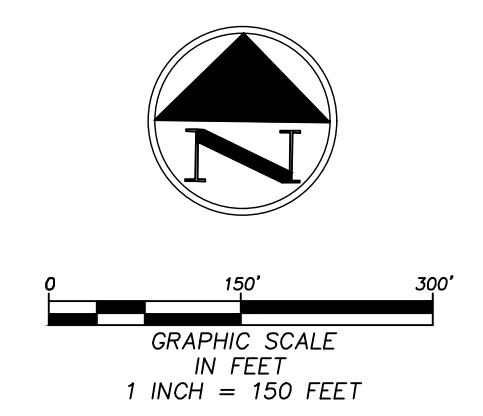

OPEN SPACE CALCULATION	Name	Area (ac)	Credit Allocation	Open Space Credit (ac)	Maintenance Responsibility
Tract A - Stormwater Pond "A"		3.53	40% of Pond Area	1.41	HOA
Tract B - Recreation Park		2.42	1:1 ratio	2.42	HOA
Tract C - Recreation Park		0.56	1:1 ratio	0.56	HOA
Tract D - Recreation Park		6.12	1:1 ratio	6.12	HOA
Tract E - Recreation Park		1.53	1:1 ratio	1.53	HOA
Tract F - Stormwater Pond "B"		11.53	40% of Pond Area	4.61	HOA
Tract G - Stormwater Pond "C"		4.11	40% of Pond Area	1.64	HOA
Tract H - Stormwater Pond "D"		9.09	40% of Pond Area	3.64	HOA
Tract I - Open Space		0.88	1:1 ratio	0.88	HOA
Tract J - Open Space		0.57	1:1 ratio	0.57	HOA
Tract K - Open Space		0.86	1:1 ratio	0.86	HOA
Tract L - Open Space		0.02	1:1 ratio	0.02	HOA
Tract M - Open Space		0.02	1:1 ratio	0.02	HOA
Tract N - Open Space		0.04	1:1 ratio	0.04	HOA
Tract O - Open Space		0.04	1:1 ratio	0.04	HOA
Tract P - Open Space		0.04	1:1 ratio	0.04	HOA
Tract Q - Open Space		0.04	1:1 ratio	0.04	HOA
Tract R - Open Space		0.04	1:1 ratio	0.04	HOA
Tract S - Open Space		0.04	1:1 ratio	0.04	HOA
Tract T - Open Space		0.04	1:1 ratio	0.04	HOA
Tract U - Open Space		0.04	1:1 ratio	0.04	HOA
Tract V - Open Space		0.04	1:1 ratio	0.04	HOA
Tract W - Open Space		0.11	1:1 ratio	0.11	HOA
Tract X - Open Space		0.04	1:1 ratio	0.04	HOA
Tract Y - Open Space		0.04	1:1 ratio	0.04	HOA
Tract Z - Open Space		0.04	1:1 ratio	0.04	HOA
Tract AA - Wetland / Conservation		22.48	40% of Wetland Area	8.99	HOA/Oceola County
Tract AB - Open Space (Reserved Future Right of Way, Hickory Trail)		2.43	1:1 ratio	2.43	HOA/Oceola County
Tract AC - Open Space (Reserved Future Right of Way, Lake Gentry)		0.54	1:1 ratio	0.54	HOA/Oceola County
Tract AD - Open Space		0.12	1:1 ratio	0.12	HOA
Tract AE - Open Space		0.12	1:1 ratio	0.12	HOA
Tract AF - Open Space		0.05	1:1 ratio	0.05	HOA
Tract AG - Open Space		0.11	1:1 ratio	0.11	HOA
Tract AH - Open Space		0.11	1:1 ratio	0.11	HOA
Excess Recreational Space		4.02	2:1 ratio	8.04	
Total Open Space Provided				45.22	
Open Space Required per LDC 4.10.2 (100% of Project Area)				41.22	

SITE TABULATION	Total
Project Area	206.1
Preserved Wetland (Tract AA)	22.48
Right of Way Dedication - Hickory Tree (Tract AB)	2.43
Right of Way Dedication - Lake Gentry (Tract AC)	0.54
Net Developable Acreage	180.65
Lots	797
Density (Lot / Net Developable Acreage)	4.41

PARKING	Provided
Lots	797
4 Spaces per Lot ⁽¹⁾	3,188
1 Space for every 2 Dwelling Units ⁽²⁾	399
Total Parking (Required)	3,587
40' - Front Load: 75'x20'	169
14' - Side Loaded Dwelling: 70'x120' (2 Car Garage + 2 Car Driveway)	56
25' - Front Loaded Dwelling: 50'x120' (2 Car Garage + 2 Car Driveway)	1,024
118' - Front Loaded Dwelling: 50'x120' (2 Car Garage + 2 Car Driveway)	472
67' - Front Loaded Dwelling: 60'x120' (2 Car Garage + 2 Car Driveway)	208
222' - Front Loaded Townhome: 20'x95' (2 Car Garage + 2 Car Driveway)	888
80' - Rear Loaded Bungalow: 45'x120' (2 Car Garage + 2 Car Driveway)	328
Off-Street Parking and Parking lot	5,724
Total (Parking Provided)	9,724
1:1 Parking Requirement based upon LDC 4.7.9	

RECREATION CALCULATION	Name	Area (ac)	Credit Allocation	Rec. Credit (ac)	Maintenance Responsibility
Tract A - Stormwater Pond "A"		3.63	25% of Pond Area	0.91	HOA
Tract B - Recreation Park		2.05	1:1 ratio	2.05	HOA
Tract C - Recreation Park		0.62	1:1 ratio	0.62	HOA
Tract D - Recreation Park		6.12	1:1 ratio	6.12	HOA
Tract E - Recreation Park		1.53	1:1 ratio	1.53	HOA
Tract F - Stormwater Pond "B"		11.53	25% of Pond Area	2.88	HOA
Tract G - Stormwater Pond "C"		4.11	25% of Pond Area	1.03	HOA
Tract H - Stormwater Pond "D"		9.09	25% of Pond Area	2.27	HOA
Adjusted Recreation Credit (Non-Building Amenity) (Tract B: Play Field)		40,500 sq-ft	1 acre for 25,000-sf Non-Building Amenity	1.58	HOA
Adjusted Recreation Credit (Non-Building Amenity) (Tract C: Dog Park)		10,000 sq-ft	1 acre for 25,000-sf Non-Building Amenity	0.40	HOA
Adjusted Recreation Credit (Building Amenity) (Tract D: Cabana)		3,000 sq-ft	1 acre for 5,000-sf Building Amenity	0.60	HOA
Adjusted Recreation Credit (Building Amenity) (Tract E: Pool)		4,500 sq-ft	1 acre for 5,000-sf Building Amenity	0.90	HOA
Adjusted Recreation Credit (Non-Building Amenity) (Tract B: Play Field)		4,200 sq-ft	1 acre for 25,000-sf Non-Building Amenity	0.17	HOA
Adjusted Recreation Credit (Non-Building Amenity) (Tract E: Dog Park)		3,100 sq-ft	1 acre for 25,000-sf Non-Building Amenity	0.12	HOA
Adjusted Recreation Credit (Non-Building Amenity) (Tract E)		1,888 sq-ft	1 acre for 25,000-sf Non-Building Amenity	0.08	HOA
Total Recreation Provided				21.66	
Recreation Required per LDC 4.10.2 (1 acre per 50 lots)				17.64	
Additional Area of Recreation Above Requirement (LDC 4.10.2 & 4.6)			2:1 ratio towards open space	4.02	

- NOTES:
- MINIMUM LOT WIDTH IS DEFINED AS A STRAIGHT LINE DISTANCE BETWEEN THE SIDE LOT LINES WHICH IS PARALLEL TO THE FRONT LOT LINE AND MEASURED FROM THE MID POINT OF THE SIDE LOT LINE.
 - WHERE THE FRONT LOT LINE IS A CURVE, THE LOT WIDTH SHALL BE MEASURED PARALLEL WITH THE CHORD OF SAID CURVE.
 - WHERE THE SIDE LOT LINES DIFFER IN LENGTH, THE LOT WIDTH SHALL BE MEASURED FROM THE SIDE LOT LINE MIDPOINT WHICH IS CLOSEST TO THE EXTREME FRONT LOT CORNER.
 - MINIMUM LOT WIDTH FOR CUL-DE-SAC LOTS SHALL BE MEASURED FROM THE MID-POINT AND AT A RIGHT ANGLE TO THE RADIAL SIDE LOT LINE. WHERE NO RADIAL SIDE LOT LINES EXIST, THE PRELIMINARY PLAT SHALL GRAPHICALLY REPRESENT COMPLIANCE WITH MINIMUM LOT WIDTH STANDARDS.
 - WHERE AN IRREGULAR SHAPED LOT EXISTS OR WHERE ANY DEVIATION FROM THESE STANDARDS ARE PROPOSED, THE PRELIMINARY PLAT SHALL GRAPHICALLY REPRESENT COMPLIANCE WITH MINIMUM LOT WIDTH STANDARDS.

Legend	Description	Count
[Blue Box]	75'x120' FRONT LOAD LOTS	= 40
[Orange Box]	50'x120' FRONT LOAD LOTS	= 14
[Purple Box]	50'x125' FRONT LOAD LOTS	= 256
[Red Box]	60'x120' FRONT LOAD LOTS	= 67
[Cyan Box]	20'x95' TOWNHOMES LOTS	= 222
[Green Box]	45'x120' REAR LOAD LOTS	= 80
	TOTAL LOTS	= 797

DESIGN	F.B. NO.	SEC.	###
DRAWN	PAGE	TWP.	####
CHECKED	SCALE AS SHOWN	RANGE	####
CAD# (see stamp)	DATE 11/3/21	DATE	BY

8 BROADWAY, SUITE 104, KISSIMMEE, FLORIDA 34741-5708
PHONE: (407) 847-9433
ENGINEERING FAX: (321) 442-1045 SURVEY FAX: (407) 847-2499
ENG. CERT. OF AUTHOR. No. 3265/SUR. CERT. OF AUTHOR. No. 3270
ENGINEERING, SURVEYING AND PLANNING
HWA
Hanson, Walter & Associates, Inc.

TRIPLE H RANCH SOUTH
PRELIMINARY SITE PLAN
SHEET No. 03 of XX
JOB No. 5437

I:\5437\ENGINEERING\CADD\PLANS\PRELIMINARY\PLANS\5-5437-OVERALL PRELIMINARY SITE PLAN.dwg * Nov 17, 2021 8:31am * plotted by: Alogras

SECTION V

**FIRST SUPPLEMENTAL
ASSESSMENT METHODOLOGY
FOR
ASSESSMENT AREA ONE**

**HICKORY TREE
COMMUNITY DEVELOPMENT DISTRICT**

Date: September 6, 2023

Prepared by

**Governmental Management Services - Central Florida, LLC
219 E. Livingston St.
Orlando, FL 32801**



Table of Contents

1.0 Introduction..... **3**
 1.1 Purpose..... **3**
 1.2 Background..... **3**
 1.3 Special Benefits and General Benefits **4**
 1.4 Requirements of a Valid Assessment Methodology **5**
 1.5 Special Benefits Exceed the Costs Allocated **5**

2.0 Assessment Methodology **5**
 2.1 Overview **5**
 2.2 Allocation of Debt..... **6**
 2.3 Allocation of Benefit **6**
 2.4 Lienability Test: Special and Peculiar Benefit to the Property **7**
 2.5 Lienability Test: Reasonable and Fair Apportionment of the Duty to Pay
 Non-Ad Valorem Assessments **7**

3.0 True-Up Mechanism..... **8**

4.0 Assessment Roll..... **8**

5.0 Appendix **9**
 Table 1: Development Program **9**
 Table 2: Capital Improvement Cost Estimates..... **10**
 Table 3: Bond Sizing..... **11**
 Table 4: Allocation of Improvement Costs **12**
 Table 5: Allocation of Total Par Debt to Each Product Type..... **13**
 Table 6: Par Debt and Annual Assessments **14**
 Table 7: Preliminary Assessment Roll **15**

GMS-CF, LLC does not represent the Hickory Tree Community
Development District as a Municipal Advisor or Securities Broker nor is GMS-CF, LLC registered to
provide such services as described in Section 15B of the
Securities and Exchange Act of 1934, as amended. Similarly, GMS-CF, LLC
does not provide the Hickory Tree Community Development District with financial
advisory services or offer investment advice in any form.

1.0 Introduction

The Hickory Tree Community Development District (the “District”) is a local unit of special-purpose government organized and existing under Chapter 190, Florida Statutes, as amended. The District plans to issue approximately \$14,860,000 of tax exempt Special Assessment Bonds, Series 2023 (the “Bonds”) for the purpose of financing a portion of certain infrastructure improvements (herein the “Assessment Area One Project” or “AA1 CIP”) within Phase 1 and Phase 2A of the District (collectively “Assessment Area One”) as more specifically described in the Supplemental Engineer’s Report dated September 6, 2023, prepared by Dewberry Engineer’s, Inc., as may be amended and supplemented from time to time (the “Engineer’s Report”).

1.1 Purpose

This First Supplemental Assessment Methodology (the “Supplemental Methodology”) supplements the Master Assessment Methodology dated June 28, 2022 (the “Master Report”). This Supplemental Methodology provides for an assessment methodology that allocates the debt to be incurred by the District to benefiting properties within Assessment Area One of the District. This Supplemental Methodology allocates the debt to properties within Assessment Area One based on the special benefits received from the AA1 CIP. This Supplemental Methodology will be supplemented to reflect the actual terms and conditions at the time of the issuance of the Bonds. This Supplemental Methodology is designed to conform to the requirements of Chapters 190 and 170, Florida Statutes as amended, with respect to special assessments and is consistent with our understanding of case law on this subject.

The District has imposed non ad valorem special assessments on the benefited lands within Assessment Area One of the District based on the Master Report and this Supplemental Methodology. It is anticipated that upon platting all of the proposed special assessments will be collected through the Uniform Method of Collection described in Chapter 197.3632, Florida Statutes, as amended. However, the decision to collect Assessment Area One Assessments by any particular method – e.g., on the tax roll or by direct bill – does not mean that such method will be used to collect the Assessment Area One Assessments in future years, and the District reserves the right in its sole discretion to select collection methods in any given year, regardless of past practices.

It is not the intent of this Supplemental Methodology to address any other assessments, if applicable, that may be levied by the District, a homeowner’s association, or any other unit of government.

1.2 Background

The District currently includes approximately 205.00 acres in Osceola County, Florida. The development program for the District's Assessment Area One currently envisions approximately 406 residential units and comprises approximately 91.94 acres. The proposed development program is depicted in Table 1. It is recognized that such land use plan may change, and this Supplemental Methodology will be modified or supplemented accordingly.

The public improvements contemplated by the District in the AA1 CIP will provide facilities that benefit the assessable property within Assessment Area One of the District. Specifically, the District will construct and/or acquire certain improvements including offsite improvements, stormwater management, utilities (water, sewer, & street lighting), roadway, entry feature, parks and amenities, professional fees, and contingency. The acquisition and construction costs are summarized in Table 2.

The assessment methodology is a four-step process.

1. The District Engineer must first determine the expected public infrastructure improvements to be provided by the District and the costs to implement the AA1 CIP.
2. The District Engineer determines the assessable acres that benefit from the District's AA1 CIP.
3. A calculation is made to determine the funding amounts necessary to acquire and/or construct the AA1 CIP.
4. This amount is initially divided equally among the benefited properties within Assessment Area One on a prorated assessable acreage basis. Ultimately, as land is platted, this amount will be assigned to each of the benefited properties based on the number of platted units.

1.3 Special Benefits and General Benefits

Improvements undertaken by the District create special and peculiar benefits to the property, different in kind and degree than general benefits, for properties within its borders as well as general benefits to the public at large.

However, as discussed within this Supplemental Methodology, these general benefits are incidental in nature and are readily distinguishable from the special and peculiar benefits that accrue to property within Assessment Area One of the District. The implementation of the AA1 CIP enables properties within the boundaries of Assessment Area One of the District to be developed. Without the District's AA1 CIP, there would be no infrastructure to support development of land within Assessment

Area One of the District. Without these improvements, development of the property within Assessment Area One of the District would be prohibited by law.

There is no doubt that the general public and property owners outside of the District will benefit from the provision of the AA1 CIP. However, these benefits will be incidental for the purpose of the AA1 CIP, which is designed solely to meet the needs of property within the District, and in particular Assessment Area One. Properties outside of the District boundaries do not depend upon the District's AA1 CIP. The property owners within the District are therefore receiving special benefits not received by those outside the District's boundaries.

1.4 Requirements of a Valid Assessment Methodology

There are two requirements under Florida law for a valid special assessment:

- 1) The properties must receive a special benefit from the improvements being paid for and constructed.
- 2) The assessments must be fairly and reasonably allocated to the properties being assessed based on the special benefit such properties receive.

Florida law provides for a wide application of special assessments that meet these two characteristics of special assessments.

1.5 Special Benefits Exceed the Costs Allocated

The special benefits provided to the property owners within Assessment Area One of the District will be equal to or greater than the costs associated with providing these benefits. The District Engineer estimates that the District's AA1 CIP that is necessary to support full development of property within Assessment Area One of the District will cost approximately \$34,532,021. FMSbonds, Inc. as the District's underwriter (the "Underwriter") has projected that financing costs required to fund a portion of the AA1 CIP, the cost of issuance of the Bonds, capitalized interest, and the funding of a debt service reserve account will be approximately \$14,860,000. The developer(s) of Assessment Area One will contribute funds or convey to the District the remaining infrastructure to complete the AA1 CIP. Without the Assessment Area One Project, the property within Assessment Area One of the District would not be able to be developed and occupied by future residents of the community.

2.0 Assessment Methodology

2.1 Overview

The District plans to issue approximately \$14,860,000 in Bonds to fund a portion of the District's AA1 CIP, a debt service reserve account, capitalized interest, and pay cost of

issuance. It is the purpose of this Supplemental Methodology to allocate the \$14,860,000 in debt to the properties within Assessment Area One of the District benefiting from the AA1 CIP.

Table 1 identifies the land uses as identified in the District Engineer's Report within Assessment Area One of the District. The District Engineer's Report includes estimated construction costs for the AA1 CIP needed to support the development of Assessment Area One, which construction costs are outlined in Table 2. The improvements needed to support the development of Assessment Area One are described in detail in the Engineer's Report and are estimated to cost \$34,532,021. Based on the estimated costs, the size of the bond issue under current market conditions needed to generate funds to pay for a portion of the AA1 CIP and related costs was determined by the Underwriter to total \$14,860,000. Table 3 shows the breakdown of the bond sizing.

2.2 Allocation of Debt

Allocation of debt is a continuous process until the development plan for Assessment Area One of the District is completed. Until the platting process occurs, the AA1 CIP funded by the Bonds benefits all acres within Assessment Area One of the District.

The initial assessments will be levied on an equal acreage basis to all acres within Assessment Area One. A fair and reasonable methodology allocates the debt incurred by the District proportionately to the properties receiving the special benefits. At this point all of the lands within Assessment Area One of the District are benefiting from the improvements.

Once platting or the recording of a declaration of condominium of any portion of Assessment Area One of the District into individual lots or units ("Assigned Properties") has begun, the assessments will be levied to the Assigned Properties based on the benefits they receive, on a first platted, first assigned basis. The "Unassigned Properties" defined as property that has not been platted or subjected to a declaration of condominium, will continue to be assessed on a per acre basis. Eventually the development plan of Assessment Area One will be completed and the debt relating to the Bonds will be allocated to the platted units within Assessment Area One of the District, which are the beneficiaries of the AA1 CIP, as depicted in Table 5, Table 6, and Table 7. If there are changes to development plan, a true up of the assessment will be calculated to determine if a debt reduction or true-up payment from the developer is required. The process is outlined in Section 3.0.

In order for debt service assessment levels to be consistent with market conditions, developer contributions are recognized. This is reflected on Table 5. Based on the product type and number of units anticipated to absorb a certain amount of the Bond

principal, it is estimated that the CDD will recognize a developer contribution equal to \$2,110,000 in eligible infrastructure.

The assignment of debt in this Supplemental Methodology sets forth the process by which debt is apportioned. As mentioned herein, this Supplemental Methodology may be supplemented from time to time if the number of planned units should change.

2.3 Allocation of Benefit

The AA1 CIP consists of offsite improvements, stormwater management, utilities (water, sewer, & street lighting), roadway, entry feature, parks and amenities, professional fees, and contingency. There are 4 product types within the planned development. The single family 50' home has been set as the base unit and has been assigned one equivalent residential unit ("ERU"). Table 4 shows the allocation of benefit to the particular land uses. It is important to note that the benefit derived from the AA1 CIP exceeds the cost that the units will be paying for such benefits.

2.4 Lienability Test: Special and Peculiar Benefit to the Property

Construction and/or acquisition by the District of its proposed AA1 CIP will provide several types of systems, facilities and services for the residents within Assessment Area One. These include offsite improvements, stormwater management, utilities (water, sewer, & street lighting), roadway, entry feature, parks and amenities, professional fees, and contingency. These improvements accrue in differing amounts and are somewhat dependent on the type of land use receiving the special benefits peculiar to those properties, which flow from the logical relationship of the improvements to the properties.

Once these determinations are made, they are reviewed in the light of the special benefits peculiar to the property, which flow to the properties as a result of their logical connection from the improvements in fact actually provided.

For the provision of the AA1 CIP, the special and peculiar benefits are:

- 1) the added use of the property,
- 2) added enjoyment of the property, and
- 3) the probability of increased marketability and value of the property.

These special and peculiar benefits are real and ascertainable but are not yet capable of being calculated as to value with mathematical certainty. However, each is more valuable than either the cost of, or the actual non-ad valorem special assessment levied for the improvement or the debt as allocated.

2.5 Lienability Test: Reasonable and Fair Apportionment of the Duty to Pay Non-Ad Valorem Assessments

A reasonable estimate of the proportion of special and peculiar benefits received from the public improvements described in the Engineer's Report relating to Assessment Area One is delineated in Table 5 (expressed as Allocation of Par Debt per Product Type). This is also shown on Table 6 depicting Allocation of Par Debt per Product Type.

The determination has been made that the duty to pay the non-ad valorem special assessments is fairly and reasonably apportioned because the special and peculiar benefits to the property derived from the acquisition and/or construction of the AA1 CIP have been apportioned to the property within Assessment Area One of the District according to reasonable estimates of the special and peculiar benefits provided consistent with the land use categories.

Accordingly, no acre or parcel of property within the boundaries of Assessment Area One of the District will have a lien for the payment of any non-ad valorem special assessment more than the determined special benefit peculiar to that property and therefore, the debt allocation will not be increased more than the debt allocation set forth in this Supplemental Methodology.

In accordance with the benefit allocation suggested for the product types in Table 4, a total debt per unit and an annual assessment per unit have been calculated for each product type (Table 6). These amounts represent the per unit debt allocation assuming \$14,860,000 in Bonds are issued, all anticipated units are built and sold as planned, and the entire proposed AA1 CIP is constructed.

3.0 True Up Mechanism

Although the District does not process plats, declaration of condominiums, site plans or revisions thereto for the developer, it does have an important role to play during the course of platting and site planning. Whenever a plat, declaration of condominium or site plan is processed, the District must allocate a portion of its debt to the property within Assessment Area One according to this Supplemental Methodology outlined herein. In addition, the District must also prevent any buildup of debt on Unassigned Properties. Otherwise, the land could be fully conveyed and/or platted without all of the debt being allocated. To preclude this, when platting for 25%, 50%, 75% and 100% of the units planned for platting has occurred within Assessment Area One of the District, the District will determine the amount of anticipated assessment revenue that remains on the Unassigned Properties, taking into account the full development plan of the District within Assessment Area One. If the total anticipated assessment revenue to be generated from the Assigned and Unassigned Properties is greater than or equal to the maximum annual debt service then no debt reduction or true-up payment is

required. In the case that the revenue generated is less than the required amount then a debt reduction or true-up payment by the landowner/developer, as applicable in the amount necessary to reduce the par amount of the outstanding bonds plus accrued interest to a level that will be supported by the new net annual debt service assessments will be required. If a true-up payment is made less than 45 days prior to an interest payment date, the amount of accrued interest will be calculated to the next succeeding interest payment date.

4.0 Assessment Roll

The District will initially distribute the liens across the property within Assessment Area One of the District boundaries on an equal acreage basis. As Assigned Properties becomes known with certainty, the District will refine its allocation of debt from a per acre basis to a per unit basis as shown in Table 6. If the land use plan changes, then the District will update Table 6 to reflect the changes as part of the foregoing true-up process. As a result, the assessment liens are neither fixed nor are they determinable with certainty on any acre of land within Assessment Area One of the District prior to the time final Assigned Properties become known. The current assessment roll is attached as Table 7.

TABLE 1
 HICKORY TREE COMMUNITY DEVELOPMENT DISTRICT
 DEVELOPMENT PROGRAM
 SUPPLEMENTAL ASSESSMENT METHODOLOGY FOR ASSESSMENT AREA ONE

Product Types	No. of Units *	Totals	ERUs per Unit (1)	Total ERUs
Townhome	92	92	0.75	69
45' Single Family	44	44	0.90	40
50' Single Family	262	262	1.00	262
70' Single Family	8	8	1.40	11
Total Units	406	406		382

(1) Benefit is allocated on an ERU basis; based on density of planned development, with a 50' Single Family unit equal to 1 ERU

* Unit mix is subject to change based on marketing and other factors

Prepared by: Governmental Management Services - Central Florida, LLC

TABLE 2
HICKORY TREE COMMUNITY DEVELOPMENT DISTRICT
INFRASTRUCTURE COST ESTIMATES
SUPPLEMENTAL ASSESSMENT METHODOLOGY FOR ASSESSMENT AREA ONE

Assessment Area One Project ("AA1 CIP") (1)	Total Cost Estimate
Offsite Improvements	\$4,265,923
Stormwater Management	\$9,184,694
Utilities (Water, Sewer, & Street Lighting)	\$8,234,070
Roadway	\$4,104,173
Entry Feature	\$250,000
Parks and Amenities	\$2,500,000
Professional Fees	\$2,853,886
Contingency	\$3,139,275
Total	\$34,532,021

(1) A detailed description of these improvements is provided in the Supplemental Engineer's Report dated September 6, 2023

Prepared by: Governmental Management Services - Central Florida, LLC

TABLE 3
HICKORY TREE COMMUNITY DEVELOPMENT DISTRICT
BOND SIZING
SUPPLEMENTAL ASSESSMENT METHODOLOGY FOR ASSESSMENT AREA ONE

Description	Total
Construction Funds	\$12,391,637
Debt Service Reserve	\$1,079,563
Capitalized Interest	\$891,600
Underwriters Discount	\$297,200
Cost of Issuance	\$200,000
Par Amount*	\$14,860,000

Bond Assumptions:

Average Coupon	6.00%
Amortization	30 years
Capitalized Interest	12 months
Debt Service Reserve	Max Annual D/S
Underwriters Discount	2%

* Par amount is subject to change based on the actual terms at the sale of the Bonds

Prepared by: Governmental Management Services - Central Florida, LLC

TABLE 4
HICKORY TREE COMMUNITY DEVELOPMENT DISTRICT
ALLOCATION OF BENEFIT
SUPPLEMENTAL ASSESSMENT METHODOLOGY FOR ASSESSMENT AREA ONE

Product Types	No. of Units *	ERU Factor	Total ERUs	% of Total ERUs	Total Improvements	
					Costs Per Product Type	Improvement Costs Per Unit
Townhome	92	0.75	69	18.07%	\$6,240,727	\$67,834
45' Single Family	44	0.90	40	10.37%	\$3,581,634	\$81,401
50' Single Family	262	1.00	262	68.62%	\$23,696,672	\$90,445
70' Single Family	8	1.40	11	2.93%	\$1,012,988	\$126,623
Totals	406		382	100.00%	\$34,532,021	

* Unit mix is subject to change based on marketing and other factors

Prepared by: Governmental Management Services - Central Florida, LLC

TABLE 5
HICKORY TREE COMMUNITY DEVELOPMENT DISTRICT
ALLOCATION OF TOTAL BENEFIT/PAR DEBT TO EACH PRODUCT TYPE
SUPPLEMENTAL ASSESSMENT METHODOLOGY FOR ASSESSMENT AREA ONE

Product Types	No. of Units *	Total Improvements Costs Per Product Type	Potential Allocation of Par Debt Per Product Type	Developer Contributions**	Allocation of Par Debt Per Product Type	Par Debt Per Unit
Townhome	92	\$6,240,727	\$3,066,867	(\$766,873)	\$2,299,995	\$24,999.94
45' Single Family	44	\$3,581,634	\$1,760,115	(\$114)	\$1,760,001	\$40,000.02
50' Single Family	262	\$23,696,672	\$11,645,207	(\$1,165,202)	\$10,480,004	\$40,000.02
70' Single Family	8	\$1,012,988	\$497,810	(\$177,810)	\$320,000	\$40,000.02
Totals	406	\$34,532,021	\$16,970,000	(\$2,110,000)	\$14,860,000	

* Unit mix is subject to change based on marketing and other factors

** In order for debt service assessment levels to be consistent with market conditions, developer contributions are recognized. Based on the product type and number of units anticipated to absorb the Bond Principal, it is estimated that the CDD will recognize a developer contribution equal to \$2,110,000 in eligible infrastructure.

Prepared by: Governmental Management Services - Central Florida, LLC

TABLE 6
HICKORY TREE COMMUNITY DEVELOPMENT DISTRICT
PAR DEBT AND ANNUAL ASSESSMENTS FOR EACH PRODUCT TYPE
SUPPLEMENTAL ASSESSMENT METHODOLOGY FOR ASSESSMENT AREA ONE

Product Types	No. of Units *	Allocation of Par Debt Per Product Type	Total Par Debt Per Unit	Maximum Annual Debt Service	Net Annual Debt Assessment Per Unit	Gross Annual Debt Assessment Per Unit (1)
Townhome	92	\$2,299,995	\$24,999.94	\$167,092.24	\$1,816.22	\$1,932.15
45' Single Family	44	\$1,760,001	\$40,000.02	\$127,862.24	\$2,905.96	\$3,091.45
50' Single Family	262	\$10,480,004	\$40,000.02	\$761,361.52	\$2,905.96	\$3,091.45
70' Single Family	8	\$320,000	\$40,000.02	\$23,247.68	\$2,905.96	\$3,091.45
Totals	406	\$14,860,000		\$1,079,564		

(1) This amount includes collection fees and early payment discounts when collected on the County Tax Bill

* Unit mix is subject to change based on marketing and other factors

Prepared by: Governmental Management Services - Central Florida, LLC

TABLE 7
HICKORY TREE COMMUNITY DEVELOPMENT DISTRICT
PRELIMINARY ASSESSMENT ROLL
SUPPLEMENTAL ASSESSMENT METHODOLOGY FOR ASSESSMENT AREA ONE

Owner	Property*	Net Acres	Total Par Debt Allocation Per Acre	Total Par Debt Allocated	Net Annual Debt Assessment Allocation	Gross Annual Debt Assessment Allocation (1)
Clayton Properties Group, Inc	Assessment Area One	91.94	\$161,627	\$14,860,000	\$1,079,563	\$1,148,471
Totals		91.94		\$14,860,000	\$1,079,563	\$1,148,471

(1) This amount includes 6% to cover collection fees and early payment discounts when collected utilizing the uniform method.

Annual Assessment Periods	30
Average Coupon Rate (%)	6.00%
Maximum Annual Debt Service	\$1,079,563

* - See Metes and Bounds, attached as Exhibit A

Prepared by: Governmental Management Services - Central Florida, LLC

Exhibit A

SKETCH OF DESCRIPTION

LEGAL DESCRIPTION

A parcel of land being all of Lots 3 through 6, 12 through 14, 19 and 30 and a portion of Lots 2, 11, 15, 18, 20, 21, 22, 29, 31, 34, 35, 36, 46 through 51, 63 and 64, SEMINOLE LAND AND INVESTMENT COMPANY'S SUBDIVISION of Section 4, Township 27 South, Range 31 East, according to the plat thereof, as recorded in Plat Book B, Page 30 of the Public Records of Osceola County, Florida, being more particularly described as follows:

Commence at the North $\frac{1}{4}$ corner of Section 4, Township 27 South, Range 31 East, Osceola County, Florida; thence $S00^{\circ}03'15''E$, a distance of 30.00 feet to a point on the South Right of Way line of Hickory Tree Road, said point also being the Point of Beginning; thence the following four (4) courses and distances along said South Right of Way line: thence $N89^{\circ}28'01''E$, a distance of 111.20 feet; thence $N89^{\circ}44'31''E$, a distance of 18.43 feet; thence $N00^{\circ}15'29''W$, a distance of 10.00 feet; thence $N89^{\circ}44'31''E$, a distance of 1,763.26 feet; thence departing said South Right of Way line, run $S00^{\circ}28'07''E$, a distance of 228.96 feet; thence $S89^{\circ}31'53''W$, a distance of 22.96 feet; thence $S00^{\circ}32'00''E$, a distance of 523.00 feet; thence $S89^{\circ}31'53''W$, a distance of 120.00 feet; thence $S00^{\circ}32'00''E$, a distance of 762.00 feet; thence $S89^{\circ}31'53''W$, a distance of 442.15 feet; thence $S00^{\circ}00'13''W$, a distance of 295.01 feet; thence $N89^{\circ}31'53''E$, a distance of 414.92 feet; thence $N00^{\circ}28'07''W$, a distance of 120.00 feet; thence $N89^{\circ}31'53''E$, a distance of 30.00 feet; thence $S00^{\circ}28'07''E$, a distance of 120.00 feet; thence $N89^{\circ}31'53''E$, a distance of 409.91 feet; thence $S00^{\circ}32'00''E$, a distance of 202.52 feet to the Point of Curvature of a curve, Concave to the West, having a Radius of 50.00 feet and a Central Angle of $35^{\circ}00'00''$; thence run Southerly along the Arc of said curve, a distance of 30.54 feet (Chord Bearing = $S16^{\circ}58'00''W$, Chord = 30.07 feet) to a Point of Tangency; thence $S34^{\circ}28'00''W$, a distance of 385.25 feet to the Point of Curvature of a curve, Concave to the Northwest, having a Radius of 50.00 feet and a Central Angle of $55^{\circ}32'00''$; thence run Southwesterly along the Arc of said curve, a distance of 48.46 feet (Chord Bearing = $S62^{\circ}14'00''W$, Chord = 46.59 feet) to a Point of Tangency; thence $N90^{\circ}00'00''W$, a distance of 477.39 feet to the Point of Curvature of a curve, Concave to the Northeast, having a Radius of 50.00 feet and a Central Angle of $57^{\circ}23'59''$; thence run Northwesterly along the Arc of said curve, a

ABBREVIATIONS/LEGEND

SEC.	SECTION	O.R.B.	OFFICIAL RECORDS BOOK
TWP.	TOWNSHIP	PGS.	PAGES
RNG.	RANGE	P.B.	PLAT BOOK
N.	NORTH	R/W	RIGHT OF WAY
S.	SOUTH	CHD.	CHORD
E.	EAST	NO./#	NUMBER
W.	WEST	●	DESCRIPTIVE POINT

NOTES
 BEARINGS AS SHOWN HEREON ARE BASED ON THE FLORIDA STATE PLANE COORDINATE SYSTEM, EAST ZONE, (NAD 83, 2007 ADJUSTMENT). THIS SURVEYOR HAS NOT MADE A SEARCH OF THE PUBLIC RECORDS FOR EASEMENTS, RESTRICTIONS, RESERVATIONS AND/OR RIGHT OF WAYS. THIS SKETCH IS NOT INTENDED TO REPRESENT A BOUNDARY SURVEY. NO CORNERS WERE SET AS A PART OF THIS SKETCH.

REQUESTED BY: **CLAYTON PROPERTIES GROUP**

DATE OF SKETCH	8/24/2023	REVISIONS	 900 Cross Prairie Parkway, Kissimmee, Florida 34744 Tel. (407) 847-2179 Fax (407) 847-6140  8/28/2023 RICHARD D. BROWN, P.S.M #5700 (DATE) NOTE: NOT VALID WITHOUT RAISED SURVEYOR'S SEAL.
SCALE	1" = 500'/200'		
F.B.	PAGE		
SECTION	4		
TWP.	27 S., RNG. 31 E.		
JOB NO.	21-094		

EXHIBIT 2A LEGAL DESCRIPTION HICKORY TREE CDD PHASES 1 & 2A



SKETCH OF DESCRIPTION

LEGAL DESCRIPTION (continued)

distance of 50.09 feet (Chord Bearing = N61°18'00"W, Chord = 48.02 feet) to a Point of Tangency; thence N32°36'01"W, a distance of 164.56 feet to the Point of Curvature of a curve, Concave to the Southwest, having a Radius of 245.00 feet and a Central Angle of 10°13'25"; thence run Northwesterly along the Arc of said curve, a distance of 43.72 feet (Chord Bearing = N37°42'43"W, Chord = 43.66 feet) to a Point of Non Tangency; thence N42°52'14"W, a distance of 254.23 feet; thence N01°16'58"E, a distance of 179.33 feet; thence N00°25'31"W, a distance of 120.00 feet; thence N89°31'53"E, a distance of 30.00 feet; thence S00°28'07"E, a distance of 120.00 feet; thence N89°31'53"E, a distance of 185.08 feet; thence N00°00'13"E, a distance of 295.01 feet; thence S89°31'53"W, a distance of 139.35 feet; thence N00°28'07"W, a distance of 100.00 feet; thence S87°07'14"W, a distance of 64.06 feet; thence S00°28'07"E, a distance of 97.31 feet; thence S89°31'53"W, a distance of 514.50 feet; thence S00°32'00"E, a distance of 100.03 feet; thence S89°21'26"W, a distance of 57.00 feet; thence S00°32'00"E, a distance of 6.23 feet; thence S89°28'00"W, a distance of 120.00 feet; thence N13°29'44"W, a distance of 124.35 feet; thence S77°24'23"W, a distance of 19.10 feet; thence N32°12'54"W, a distance of 59.70 feet; thence N84°31'17"W, a distance of 78.06 feet; thence N00°03'31"E, a distance of 85.38 feet; thence N27°16'38"E, a distance of 59.34 feet; thence N00°32'00"W, a distance of 465.71 feet to a Point on a Non-Tangent Curve, Concave to the Southwest, having a Radius of 25.09 feet and a Central Angle of 89°30'52"; thence run Northwesterly along the arc of said curve, a distance of 39.20 feet (Chord Bearing = N45°30'03"W, Chord = 35.34 feet) to a Point of Non Tangency; thence S89°31'53"W, a distance of 565.00 feet; thence N86°16'03"W, a distance of 107.33 feet; thence S89°31'53"W, a distance of 455.02 feet; thence N00°32'17"W, a distance of 243.60 feet; thence S89°28'29"W, a distance of 413.97 feet to a point on the East Right of Way line of Lake Gentry Road; thence N00°50'25"W, along said East Right of Way line, a distance of 562.96 feet to a point on the South Right of Way line of Hickory Tree Road; thence the following two (2) courses and distances along said South Right of Way line: thence N89°53'31"E, a distance of 414.69 feet; thence N89°28'01"E, a distance of 868.66 feet to the Point of Beginning.

Containing 91.94 acres, more or less.

JOHNSTON'S
SURVEYING INC.
900 Cross Prairie Parkway, Kissimmee, Florida 34744
Tel. (407) 847-2179 Fax (407) 847-6140



**EXHIBIT 2A
LEGAL DESCRIPTION
HICKORY TREE CDD
PHASES 1 & 2A**

SHEET 2 OF 7

SECTION VI

RESOLUTION 2023-07

A RESOLUTION OF THE BOARD OF SUPERVISORS OF HICKORY TREE COMMUNITY DEVELOPMENT DISTRICT AUTHORIZING THE ISSUANCE OF ITS HICKORY TREE COMMUNITY DEVELOPMENT DISTRICT SPECIAL ASSESSMENT BONDS, SERIES 2023 (ASSESSMENT AREA ONE PROJECT) (THE "ASSESSMENT AREA ONE BONDS"); DETERMINING CERTAIN DETAILS OF THE ASSESSMENT AREA ONE BONDS AND ESTABLISHING CERTAIN PARAMETERS FOR THE SALE THEREOF; APPROVING THE FORM OF AND AUTHORIZING THE EXECUTION AND DELIVERY OF A FIRST SUPPLEMENTAL TRUST INDENTURE; AUTHORIZING THE NEGOTIATED SALE OF THE ASSESSMENT AREA ONE BONDS; APPROVING THE FORM OF AND AUTHORIZING THE EXECUTION AND DELIVERY OF A BOND PURCHASE CONTRACT WITH RESPECT TO THE ASSESSMENT AREA ONE BONDS AND AWARDING THE ASSESSMENT AREA ONE BONDS TO THE UNDERWRITER NAMED THEREIN; APPROVING THE FORM OF AND AUTHORIZING THE DISTRIBUTION OF A PRELIMINARY LIMITED OFFERING MEMORANDUM RELATING TO THE ASSESSMENT AREA ONE BONDS AND ITS USE BY THE UNDERWRITER IN CONNECTION WITH THE OFFERING FOR SALE OF THE ASSESSMENT AREA ONE BONDS; APPROVING THE EXECUTION AND DELIVERY OF A FINAL LIMITED OFFERING MEMORANDUM RELATING TO THE ASSESSMENT AREA ONE BONDS; APPROVING THE FORM OF AND AUTHORIZING THE EXECUTION AND DELIVERY OF A CONTINUING DISCLOSURE AGREEMENT; PROVIDING FOR THE APPLICATION OF ASSESSMENT AREA ONE BOND PROCEEDS; AUTHORIZING THE PROPER OFFICIALS TO DO ALL THINGS DEEMED NECESSARY IN CONNECTION WITH THE ISSUANCE, SALE AND DELIVERY OF THE ASSESSMENT AREA ONE BONDS; MAKING CERTAIN DECLARATIONS; PROVIDING FOR SEVERABILITY AND AN EFFECTIVE DATE AND FOR OTHER PURPOSES.

WHEREAS, Hickory Tree Community Development District (the "District") is a local unit of special purpose government duly organized and existing under the provisions of the Uniform Community Development District Act of 1980, Chapter 190, Florida Statutes, as amended (the "Act") and created by Ordinance No. 2022-60 enacted by the Board of County Commissioners of Osceola County, Florida on June 27, 2022, which became effective on June 29, 2022; and

WHEREAS, the District was created for the purpose of delivering certain community development services and facilities within and outside its jurisdiction, and the District has decided to undertake the planning, financing, construction and/or acquisition of public infrastructure improvements including, but not limited to, entry features and signage, stormwater management facilities, water and sewer facilities, street lighting, parks and recreational facilities, and roadways,

and associated professional fees and incidental costs related thereto pursuant to the Act (the "Project"); and

WHEREAS, pursuant to the Act and Resolution No. 2022-26 duly adopted by the Board of Supervisors of the District (the "Board of Supervisors") on July 14, 2022 (the "Bond Resolution"), the Board of Supervisors has approved the form of a Master Trust Indenture (the "Master Indenture"), between the District and U.S. Bank Trust Company, National Association, as Trustee (the "Trustee"); and

WHEREAS, the District previously approved the Master Assessment Methodology dated June 28, 2022 (the "Master Assessment Methodology Report"), prepared by Governmental Management Services – Central Florida, LLC, setting forth the District's methodology for allocating debt to property within the District; and

WHEREAS, the District duly adopted Resolution No. 2022-27 on July 14, 2022, declaring the levy and collection of special assessments (the "Special Assessments") pursuant to the Act and Chapter 170, Florida Statutes, indicating the location, nature and estimated cost of the improvements which cost is to be defrayed by the Special Assessments, providing the manner in which the Special Assessments will be made, designating the lands upon which the Special Assessments will be levied, authorizing the preparation of a preliminary assessment roll and fixing the time and place of a public hearing; and

WHEREAS, the District duly adopted Resolution No. 2022-28 on July 14, 2022 setting a public hearing to be held on September 8, 2022, for the purpose of hearing public comment on imposing the Special Assessments; and

WHEREAS, the District duly adopted Resolution No. 2022-36 on September 8, 2022, authorizing the undertaking of the Project, the first portion of which is to be financed with the proceeds of the Assessment Area One Bonds (as hereinafter defined), as described more particularly in the Hickory Tree Community Development District Engineer's Report dated June 28, 2022, as supplemented by the Supplemental Engineer's Report dated September 6, 2023, each prepared by Dewberry Engineer's Inc. and equalizing, approving, confirming and levying the Special Assessments on the property within the District benefited by the Project; and

WHEREAS, the District has determined it to be in the best interest of the landowners of the District, for the District to issue, and the District has determined to issue its first Series of Bonds designated as the "Hickory Tree Community Development District Special Assessment Bonds, Series 2023 (Assessment Area One Project)" (the "Assessment Area One Bonds") for the primary purpose of providing funds to pay all or a portion of the costs of the planning, financing, acquisition, construction, equipping and installation of public infrastructure comprising the first phase of the Project and expected to include 406 homesites (the "Assessment Area One Project"), as summarized in Schedule I, attached hereto; and

WHEREAS, the District obtained a final judgment in the Ninth Judicial Circuit Court in and for Osceola County, Florida on December 20, 2022 validating Bonds to be issued under the Indenture (as defined herein), with no timely appeals filed; and

WHEREAS, the Assessment Area One Bonds will be secured by Special Assessments levied and imposed on assessable land within the District in accordance with the Master Assessment Methodology as supplemented by the Supplemental Assessment Methodology for Assessment Area One dated September 6, 2023; and

WHEREAS, there has been submitted to this meeting with respect to the issuance and sale of the Assessment Area One Bonds and submitted to the Board:

- (i) a form of First Supplemental Trust Indenture between the Trustee and the District attached as Exhibit A hereto (the "First Supplemental Indenture" and, together with the Master Indenture, the "Indenture");
- (ii) a form of Bond Purchase Contract with respect to the Assessment Area One Bonds between FMSbonds, Inc. (the "Underwriter") and the District attached as Exhibit B hereto (the "Bond Purchase Contract"), together with the form of a disclosure statement attached to the Bond Purchase Contract in accordance with Section 218.385, Florida Statutes;
- (iii) a form of Preliminary Limited Offering Memorandum relating to the Assessment Area One Bonds, attached as Exhibit C hereto (the "Preliminary Limited Offering Memorandum");
- (iv) a form of Rule 15c2-12 Certificate of the District relating to the Preliminary Limited Offering Memorandum, attached as Exhibit D hereto (the "Rule 15c2-12 Certificate"); and
- (v) a form of the Continuing Disclosure Agreement (the "Continuing Disclosure Agreement") to be entered into among the District, the dissemination agent named therein (the "Dissemination Agent"), and any landowner constituting an "Obligated Person" under the terms of the Continuing Disclosure Agreement, attached as Exhibit E hereto;

WHEREAS, any capitalized term used herein and not otherwise expressly defined herein shall have the meaning ascribed thereto in the Indenture; and

NOW, THEREFORE, BE IT RESOLVED by the Board of Supervisors of Hickory Tree Community Development District, as follows:

Section 1. Authorization of Issuance of Assessment Area One Bonds. There are hereby authorized and directed to be issued: the Hickory Tree Community Development District Special Assessment Bonds, Series 2023 (the "Assessment Area One Bonds") in an aggregate principal amount not to exceed \$16,000,000, for the purposes of (i) providing funds to pay all or a portion of the costs of the planning, financing, acquisition, construction, equipping and installation of the Assessment Area One Project, (ii) making a deposit to the Assessment Area One Reserve Account in an amount equal to the Assessment Area One Reserve Requirement, (iii) funding a portion of the interest coming due on the Assessment Area One Bonds, and (iv) paying certain costs of issuance in respect of the Assessment Area One Bonds. The Assessment Area One Bonds

shall be issued under and secured by the Indenture, the form of which by reference is hereby incorporated into this resolution as if set forth in full herein.

Section 2. Details of the Assessment Area One Bonds. The District hereby determines that the Assessment Area One Bonds shall mature in the amounts and at the times, shall bear interest at the rates, be redeemable at the redemption prices and in the manner as determined by the Chairperson of the Board of Supervisors of the District (the "Chairperson") or any member of the Board of Supervisors designated by the Chairperson (a "Designated Member"), prior to the sale of said Assessment Area One Bonds, all in a manner consistent with the requirements of the Bond Resolution and within the parameters set forth in Section 5 hereof.

Section 3. First Supplemental Indenture. The District hereby approves and authorizes the execution of the First Supplemental Indenture by the Chairperson or any Designated Member and the Secretary or any Assistant Secretary of the Board of Supervisors (the "Secretary") and the delivery of the First Supplemental Indenture in substantially the form thereof attached as Exhibit A hereto, with such changes therein as shall be approved by the Chairperson or Designated Member executing the same, with such execution to constitute conclusive evidence of such officer's approval and the District's approval of any changes therein from the form of First Supplemental Indenture attached hereto.

Section 4. Negotiated Sale. The Assessment Area One Bonds shall be sold by a negotiated sale to the Underwriter. It is hereby determined by the District that a negotiated sale of the Assessment Area One Bonds to the Underwriter will best effectuate the purposes of the Act, is in the best interests of the District and is necessitated by, in general, the characteristics of the issues and prevailing market conditions and specifically, the following additional reasons:

(i) because of the complexity of the financing structure of the Assessment Area One Bonds, including the pledge of Special Assessments as security for the Assessment Area One Bonds, it is desirable to sell the Assessment Area One Bonds pursuant to a negotiated sale so as to have an underwriter involved from the outset of the financing to assist in these matters;

(ii) because of changing market conditions for tax-exempt bonds and the necessity of being able to adjust the terms of the Assessment Area One Bonds, it is in the best interests of the District to sell the Assessment Area One Bonds by a negotiated sale;

(iii) the Underwriter has participated in structuring the issuance of the Assessment Area One Bonds and can assist the District in attempting to obtain the most attractive financing for the District;

(iv) the Assessment Area One Bonds do not bear a credit rating and will be offered initially only to accredited investors within the meaning of Chapter 517, Florida Statutes, and the rules of the Florida Department of Financial Services promulgated thereunder; and

(v) the District will not be adversely affected if the Assessment Area One Bonds are not sold pursuant to a competitive sale.

Section 5. Bond Purchase Contract. The District hereby approves the form of the Bond Purchase Contract submitted by the Underwriter and attached as Exhibit B hereto, and the sale of the Assessment Area One Bonds by the District upon the terms and conditions set forth in the Bond Purchase Contract is hereby approved. The Chairperson or a Designated Member are each hereby authorized, acting individually, to execute the Bond Purchase Contract and to deliver the Bond Purchase Contract to the Underwriter. The Bond Purchase Contract shall be in substantially the form of the Bond Purchase Contract attached as Exhibit B hereto with such changes, amendments, modifications, omissions and additions as may be approved by the Chairperson or the Designated Member; provided, however,

(i) If the Assessment Area One Bonds are subject to optional redemption, which determination will be made on or before the sale date of the Assessment Area One Bonds, the first optional call date and the redemption price shall be determined on or before the Bond Purchase Contract is executed;

(ii) The interest rate on the Assessment Area One Bonds shall not exceed an average net interest cost rate, which shall be computed by adding 300 basis points to The Bond Buyer "20 Bond Index" published immediately preceding the first day of the calendar month in which the bonds are sold, as provided in Section 215.84(3), Florida Statutes, as amended;

(iii) The aggregate principal amount of the Assessment Area One Bonds shall not exceed \$16,000,000;

(iv) The Assessment Area One Bonds shall have a final maturity not later than the maximum term allowed by Florida law, with a principal amortization period of no longer than thirty (30) years; and

(v) The price at which the Assessment Area One Bonds shall be sold to the Underwriter shall not be less than 98.0% of the aggregate face amount of the Assessment Area One Bonds, exclusive of original issue discount.

Execution by the Chairperson or a Designated Member of the Bond Purchase Contract shall be deemed to be conclusive evidence of approval of such changes.

Section 6. Preliminary Limited Offering Memorandum; Final Limited Offering Memorandum. The District hereby approves the form of the Preliminary Limited Offering Memorandum submitted to this meeting and attached as Exhibit C hereto and authorizes its distribution and use in connection with the limited offering for sale of the Assessment Area One Bonds. The preparation of a final Limited Offering Memorandum relating to the Assessment Area One Bonds (the "Limited Offering Memorandum") is hereby approved and the Chairperson or any Designated Member is hereby authorized to execute such final Limited Offering Memorandum to be dated the date of the award of the Assessment Area One Bonds and, upon such award, to deliver the same to the Underwriter for use by it in connection with the sale and distribution of the Assessment Area One Bonds. The Limited Offering Memorandum shall be substantially in the form of the Preliminary Limited Offering Memorandum attached as Exhibit C hereto, with such changes as shall be approved by the Chairperson or Designated Member as necessary to conform

the details of the Assessment Area One Bonds and such other insertions, modifications and changes as may be approved by the Chairperson or Designated Member. The execution and delivery of the Limited Offering Memorandum by the Chairperson or Designated Member shall constitute evidence of the approval thereof. The District hereby authorizes the use of the Limited Offering Memorandum and the information contained therein in connection with the offering and sale of the Assessment Area One Bonds. The Chairperson is further authorized to deem the Preliminary Limited Offering Memorandum "final" within the meaning of Rule 15c2-12 of the Securities and Exchange Commission under the Securities Exchange Act of 1934, in the form as mailed, and in furtherance thereof to execute the Rule 15c2-12 Certificate evidencing the same substantially in the forms attached as Exhibit D hereto.

Section 7. Continuing Disclosure. The District hereby authorizes and approves the execution and delivery of the Continuing Disclosure Agreement by and among the District, the Dissemination Agent and any landowner constituting an "Obligated Person" under the Continuing Disclosure Agreement, by the Chairperson or a Designated Member substantially in the form presented to this meeting and attached as Exhibit E hereto, with such changes therein as shall be approved by the Chairperson or Designated Member executing the same, with such execution to constitute conclusive evidence of such officer's approval and the District's approval of any changes therein from the form of Continuing Disclosure Agreement attached hereto. The Continuing Disclosure Agreement is being executed by the District in order to assist the Underwriter in complying with Rule 15c2-12(b)(5) promulgated by the U.S. Securities and Exchange Commission.

Section 8. Application of Bond Proceeds. The proceeds of the Assessment Area One Bonds shall be applied in the manner required in the First Supplemental Indenture.

Section 9. Further Official Action; Ratification of Prior and Subsequent Acts. The Chairperson, the Secretary and each member of the Board of Supervisors of the District and any other proper official of the District are each hereby authorized and directed to execute and deliver any and all documents and instruments (including, without limitation, any documents required by the Trustee to evidence its rights and obligations with respect to the Assessment Area One Bonds, any documents required in connection with implementation of a book-entry system of registration, and investment agreements relating to the investment of the proceeds of the Assessment Area One Bonds and any agreements in connection with maintaining the exclusion of interest on the Assessment Area One Bonds from gross income of the holders thereof) and to do and cause to be done any and all acts and things necessary or desirable for carrying out the transactions contemplated by this Resolution. In the event that the Chairperson or the Secretary is unable to execute and deliver the documents herein contemplated, such documents shall be executed and delivered by the respective designee of such officer or official or any other duly authorized officer or official of the District. The Secretary or any Assistant Secretary is hereby authorized and directed to apply and attest the official seal of the District to any agreement or instrument authorized or approved herein that requires such a seal and attestation. The Chairperson or any Designated Member may, among other things, change the date of any document accompanying this Resolution as an exhibit. Execution by the Chairperson or a Designated Member of such document shall be deemed to be conclusive evidence of approval of such change of date. All of the acts and doings of such members of the Board, the officers of the District, and

the agents and employees of the District, which are in conformity with the intent and purposes of this Resolution, whether heretofore or hereafter taken or done, shall be and are hereby ratified, confirmed and approved.

Section 10. Severability. If any section, paragraph, clause or provision of this Resolution shall be held to be invalid or ineffective for any reason, the remainder of this Resolution shall continue in full force and effect, it being expressly hereby found and declared that the remainder of this Resolution would have been adopted despite the invalidity or ineffectiveness of such section, paragraph, clause or provision.

Section 11. Inconsistent Proceedings. All resolutions or proceedings, or parts thereof, in conflict with the provisions hereof are to the extent of such conflict hereby repealed or amended to the extent of such inconsistency.

Section 12. Ratification of Prior Acts. All actions previously taken by or on behalf of the District in connection with the issuance of the Assessment Area One Bonds are hereby authorized, ratified and confirmed.

Section 13. Public Meetings. It is hereby found and determined that all formal actions of the District concerning and relating to the adoption of this Resolution and the consummation of the transactions contemplated by this Resolution were adopted in open meetings of the District, and that all deliberations of the District that resulted in such formal action were in meetings open to the public, in compliance with all legal requirements.

Section 14. Effective Date. This Resolution shall take effect immediately upon its adoption.

[REMAINDER OF PAGE INTENTIONALLY LEFT BLANK – SIGNATURE PAGE
FOLLOWS]

SCHEDULE I

DESCRIPTION OF ASSESSMENT AREA ONE PROJECT

The Assessment Area One Project includes, but is not limited to, Phases 1 & 2A of the public improvements described in the table below from the Supplemental Engineer's Report dated September 6, 2023, and prepared by Dewberry Engineers Inc.

COST ESTIMATE			
FACILITY TYPE	PHASES 1 & 2A 2023-2025 (406 LOTS)	"PHASES 2B & 3 2024-2027 (391 LOTS)"	TOTAL (797 LOTS)
Offsite Improvements ⁽¹⁾⁽⁵⁾⁽⁷⁾⁽¹¹⁾	\$4,265,923	\$1,711,798	\$5,977,721
Stormwater Management ⁽¹⁾⁽²⁾⁽³⁾⁽⁵⁾⁽⁶⁾⁽⁷⁾	\$9,184,694	\$3,378,436	\$12,563,130
Utilities (Water, Sewer, & Street Lighting) ⁽¹⁾⁽⁵⁾⁽⁷⁾⁽⁹⁾⁽¹¹⁾	\$8,234,070	\$3,028,764	\$11,262,834
Roadway ⁽¹⁾⁽⁴⁾⁽⁵⁾⁽⁷⁾	\$4,104,173	\$1,509,651	\$5,613,824
Entry Feature ⁽¹⁾⁽⁷⁾⁽⁹⁾⁽⁹⁾⁽¹¹⁾	\$250,000	\$250,000	\$500,000
Parks and Amenities ⁽¹⁾⁽⁷⁾⁽¹¹⁾	\$2,500,000	\$1,500,000	
Subtotal	\$28,538,860	\$11,378,649	\$39,917,509
Professional Fees (10%)			\$3,991,751
Subtotal			\$43,909,260
Contingency (10%)			\$4,390,926
Total			\$48,300,186

Notes:

1. Infrastructure consists of public roadway improvements, Stormwater management facilities, master sanitary sewer lift station and utilities, entry feature, landscaping and signage, and public neighborhood parks, all of which will be located on land owned by or subject to a permanent easement in favor of the District or another governmental entity.
2. Excludes grading of each lot in conjunction with home construction, which will be provided by home builder.
3. Includes stormwater pond excavation. Does not include the cost of transportation of fill for use of private lots.
4. Includes sub-grade, base, asphalt paving, curbing, and civil/site engineering.
5. Includes subdivision infrastructure and civil/site engineering.
6. Stormwater does not include grading associated with building pads.
7. Estimates are based on 2023 cost.
8. Includes entry features, signage, hardscape, landscape, irrigation, and fencing.
9. CDD will enter into a Lighting Agreement with OUC for the street light poles and lighting service. Includes only the incremental cost of undergrounding.
10. Estimates based on 797 lots.
11. The costs associated with the infrastructure are a master cost and is effectively shared by the entire project (all phases).

EXHIBIT A

FORM OF FIRST SUPPLEMENTAL TRUST INDENTURE

FIRST SUPPLEMENTAL TRUST INDENTURE

between

HICKORY TREE COMMUNITY DEVELOPMENT DISTRICT

and

U.S. BANK TRUST COMPANY, NATIONAL ASSOCIATION

as Trustee

Dated as of [_____] 1, 2023

Authorizing and Securing
\$ _____
HICKORY TREE COMMUNITY DEVELOPMENT DISTRICT
SPECIAL ASSESSMENT BONDS, SERIES 2023
(ASSESSMENT AREA ONE PROJECT)

TABLE OF CONTENTS

Page

**ARTICLE I
DEFINITIONS**

**ARTICLE II
THE ASSESSMENT AREA ONE BONDS**

SECTION 2.01.	Amounts and Terms of Assessment Area One Bonds; Issue of Assessment Area One Bonds	9
SECTION 2.02.	Execution	9
SECTION 2.03.	Authentication.....	9
SECTION 2.04.	Purpose, Designation and Denominations of, and Interest Accruals on, the Assessment Area One Bonds	9
SECTION 2.05.	Debt Service on the Assessment Area One Bonds	10
SECTION 2.06.	Disposition of Assessment Area One Bond Proceeds	11
SECTION 2.07.	Book-Entry Form of Assessment Area One Bonds	11
SECTION 2.08.	Appointment of Registrar and Paying Agent.....	12
SECTION 2.09.	Conditions Precedent to Issuance of the Assessment Area One Bonds.....	13

**ARTICLE III
REDEMPTION OF ASSESSMENT AREA ONE BONDS**

SECTION 3.01.	Redemption Dates and Prices	14
SECTION 3.02.	Notice of Redemption	17

**ARTICLE IV
ESTABLISHMENT OF CERTAIN FUNDS AND ACCOUNTS;
ADDITIONAL COVENANTS OF THE ISSUER; PREPAYMENTS;
REMOVAL OF ASSESSMENT AREA ONE SPECIAL ASSESSMENT LIENS**

SECTION 4.01.	Establishment of Certain Funds and Accounts	18
SECTION 4.02.	Assessment Area One Revenue Account.....	22
SECTION 4.03.	Power to Issue Assessment Area One Bonds and Create Lien.....	23
SECTION 4.04.	Assessment Area One Project to Conform to Engineer's Report.....	24
SECTION 4.05.	Prepayments; Removal of Assessment Area One Special Assessment Liens.....	24

**ARTICLE V
COVENANTS AND DESIGNATIONS OF THE ISSUER**

SECTION 5.01.	Collection of Assessment Area One Special Assessments	25
SECTION 5.02.	Continuing Disclosure	25
SECTION 5.03.	Investment of Funds and Accounts.....	25
SECTION 5.04.	Additional Bonds	25

SECTION 5.05. Acknowledgement Regarding the Moneys in the Assessment Area
One Acquisition and Construction Account Following an Event of Default 26

**ARTICLE VI
THE TRUSTEE; THE PAYING AGENT AND REGISTRAR**

SECTION 6.01. Acceptance of Trust 27
SECTION 6.02. Trustee's Duties 27

**ARTICLE VII
MISCELLANEOUS PROVISIONS**

SECTION 7.01. Interpretation of First Supplemental Trust Indenture 28
SECTION 7.02. Amendments 28
SECTION 7.03. Counterparts 28
SECTION 7.04. Appendices and Exhibits 28
SECTION 7.05. Payment Dates 28
SECTION 7.06. No Rights Conferred on Others 28

EXHIBIT A DESCRIPTION OF ASSESSMENT AREA ONE PROJECT
EXHIBIT B FORM OF ASSESSMENT AREA ONE BOND
EXHIBIT C FORMS OF REQUISITIONS
EXHIBIT D FORM OF INVESTOR LETTER

THIS FIRST SUPPLEMENTAL TRUST INDENTURE (the "First Supplemental Trust Indenture"), dated as of [_____] 1, 2023, between the **HICKORY TREE COMMUNITY DEVELOPMENT DISTRICT** (together with its successors and assigns, the "Issuer" or the "District"), a local unit of special-purpose government organized and existing under the laws of the State of Florida, and **U.S. BANK TRUST COMPANY, NATIONAL ASSOCIATION**, a national banking association duly organized and existing under the laws of the United States of America and having a designated corporate trust office in Fort Lauderdale, Florida, as trustee (said national banking association and any bank or trust company becoming successor trustee under this First Supplemental Trust Indenture being hereinafter referred to as the "Trustee");

WITNESSETH:

WHEREAS, the Issuer is a local unit of special purpose government duly organized and existing under the provisions of the Uniform Community Development District Act of 1980, Chapter 190, Florida Statutes, as amended (the "Act") created pursuant to Ordinance No. 2022-60 enacted by the Board of County Commissioners of Osceola County (the "County") on June 27, 2022, which became effective on June 29, 2022, for the purposes of delivering community development services and facilities to property to be served by the District (as defined below); and

WHEREAS, the premises governed by the Issuer (the "District Lands") (as further described in Exhibit A attached to the Master Indenture (as defined herein)) currently consist of approximately 205 gross acres of land located entirely within the County; and

WHEREAS, the Issuer has been created for the purpose of delivering certain community development services and facilities for the benefit of the District Lands; and

WHEREAS, the Issuer has determined to undertake the acquisition and/or construction of public infrastructure improvements and community facilities for the special benefit of the District Lands to be developed in two phases (collectively, the "Project"), as described in the Hickory Tree Community Development District Engineer's Report dated June 28, 2022, as supplemented by the [_____] dated _____, 2023], each prepared by prepared by Dewberry Engineers Inc. and summarized in Exhibit A attached hereto; and

WHEREAS, the Issuer has previously adopted Resolution No. 2022-26 on July 14, 2022 (the "Original Authorizing Resolution"), authorizing the issuance of not to exceed \$53,090,000 in aggregate principal amount of its Special Assessment Bonds (the "Bonds") to finance all or a portion of the planning, design, acquisition and construction costs of certain improvements pursuant to the Act for the special benefit of the District Lands or portions thereof and approving the form of and authorizing the execution and delivery of the Master Indenture; and

WHEREAS, Clayton Properties Group, Inc., a Tennessee corporation doing business as Highland Homes and a wholly owned subsidiary of Berkshire Hathaway, is the owner of the lands (the "Assessment Area One Landowner") planned for 406 residential units ("Assessment Area One") and associated infrastructure; and

WHEREAS, the Assessment Area One Landowner will construct or cause the Issuer to construct all or a portion of the public infrastructure necessary to serve Assessment Area One (such public infrastructure as described on Exhibit A attached hereto and collectively referred to as the "Assessment Area One Project"); and

WHEREAS, the Issuer has determined to issue its first Series of Bonds, as authorized by Resolution No. 2023-07 duly adopted by the Board on September 6, 2023 and designated as the "Hickory Tree Community Development District Special Assessment Bonds, Series 2023 (Assessment Area One Project)" (the "Assessment Area One Bonds"), pursuant to that certain Master Indenture and this First Supplemental Trust Indenture (hereinafter sometimes collectively referred to as the "Assessment Area One Indenture"); and

WHEREAS, in the manner provided herein, the net proceeds of the Assessment Area One Bonds will be used for the purposes of (i) providing funds to pay all or a portion of the costs of the planning, financing, acquisition, construction, equipping and installation of the Assessment Area One Project, (ii) funding a deposit to the Assessment Area One Reserve Account in the amount of the Assessment Area One Reserve Requirement, (iii) paying a portion of the interest coming due on the Assessment Area One Bonds, and (iv) paying the costs of issuance of the Assessment Area One Bonds; and

WHEREAS, the Assessment Area One Bonds will be secured by a pledge of Assessment Area One Pledged Revenues (as herein defined) to the extent provided herein.

NOW, THEREFORE, THIS FIRST SUPPLEMENTAL TRUST INDENTURE WITNESSETH, that to provide for the issuance of the Assessment Area One Bonds, the security and payment of the principal or redemption price thereof (as the case may be) and interest thereon, the rights of the Bondholders and the performance and observance of all of the covenants contained herein and in said Assessment Area One Bonds, and for and in consideration of the mutual covenants herein contained and of the purchase and acceptance of the Assessment Area One Bonds by the Holders thereof, from time to time, and of the acceptance by the Trustee of the trusts hereby created, and intending to be legally bound hereby, the Issuer does hereby assign, transfer, set over and pledge to U.S. Bank Trust Company, National Association, as Trustee, its successors in trust and its assigns forever, and grants a lien on all of the right, title and interest of the Issuer in and to the Assessment Area One Pledged Revenues as security for the payment of the principal, redemption or purchase price of (as the case may be) and interest on the Assessment Area One Bonds issued hereunder, all in the manner hereinafter provided, and the Issuer further hereby agrees with and covenants unto the Trustee as follows:

TO HAVE AND TO HOLD the same and, to the extent the same may be lawfully granted, any other revenues, property, contracts or contract rights, accounts receivable, chattel paper, instruments, general intangibles or other rights and the proceeds thereof, which may, by delivery, assignment or otherwise, be subject to the lien created by the Assessment Area One Indenture with respect to the Assessment Area One Bonds.

IN TRUST NEVERTHELESS, for the equal and ratable benefit and security of all present and future Holders of the Assessment Area One Bonds issued and to be issued under this First Supplemental Trust Indenture, without preference, priority or distinction as to lien or

otherwise (except as otherwise specifically provided in this First Supplemental Trust Indenture) of any one Assessment Area One Bond over any other Assessment Area One Bond, all as provided in the Assessment Area One Indenture.

PROVIDED, HOWEVER, that if the Issuer, its successors or assigns, shall well and truly pay, or cause to be paid, or make due provision for the payment of the principal or redemption price of the Assessment Area One Bonds issued, secured and Outstanding hereunder and the interest due or to become due thereon, at the times and in the manner mentioned in such Assessment Area One Bonds and the Assessment Area One Indenture, according to the true intent and meaning thereof and hereof, and the Issuer shall well and truly keep, perform and observe all the covenants and conditions pursuant to the terms of the Assessment Area One Indenture to be kept, performed and observed by it, and shall pay or cause to be paid to the Trustee all sums of money due or to become due to it in accordance with the terms and provisions hereof, then upon such final payments this First Supplemental Trust Indenture and the rights hereby granted shall cease and terminate, otherwise this First Supplemental Trust Indenture to be and remain in full force and effect.

ARTICLE I DEFINITIONS

In this First Supplemental Trust Indenture capitalized terms used without definition shall have the meanings ascribed thereto in the Master Indenture and, in addition to certain terms defined in the recitals above, the following terms shall have the meanings specified below, unless otherwise expressly provided or unless the context otherwise requires:

"Acquisition Agreement" shall mean that certain Agreement by and between the District and the Assessment Area One Landowner regarding the acquisition of certain work product, improvements and real property, dated [_____] __, 2023.

"Arbitrage Certificate" shall mean that certain Arbitrage Certificate, including arbitrage rebate covenants, of the Issuer, dated [_____] __, 2023, relating to certain restrictions on arbitrage under the Code with respect to the Assessment Area One Bonds.

"Assessment Area One" shall mean the approximately 205 acres of land within the District currently planned for 406 family lots, recreation & amenity areas, and associated infrastructure.

"Assessment Area One Acquisition and Construction Account" shall mean the Account so designated, established as a separate Account within the Acquisition and Construction Fund pursuant to Section 4.01(a) of this First Supplemental Trust Indenture in connection with components of the Assessment Area One Project.

"Assessment Area One Bond Redemption Account" shall mean the Account so designated, established as a separate Account within the Bond Redemption Fund pursuant to Section 4.01(g) of this First Supplemental Trust Indenture.

"Assessment Area One Bonds" shall mean the \$_____ aggregate principal amount of Hickory Tree Community Development District Special Assessment Bonds, Series

2023 (Assessment Area One Project), to be issued as fully registered Bonds in accordance with the provisions of the Master Indenture and this First Supplemental Trust Indenture, and secured and authorized by the Master Indenture and this First Supplemental Trust Indenture.

"Assessment Area One Costs of Issuance Account" shall mean the Account so designated, established as a separate Account within the Acquisition and Construction Fund pursuant to Section 4.01(a) of this First Supplemental Trust Indenture.

"Assessment Area One General Redemption Subaccount" shall mean the subaccount so designated, established as a separate subaccount under the Assessment Area One Bond Redemption Account pursuant to Section 4.01(g) of this First Supplemental Trust Indenture.

"Assessment Area One Indenture" shall mean collectively, the Master Indenture and this First Supplemental Trust Indenture.

"Assessment Area One Interest Account" shall mean the Account so designated, established as a separate Account within the Debt Service Fund pursuant to Section 4.01(d) of this First Supplemental Trust Indenture.

"Assessment Area One Landowner" shall mean Clayton Properties Group, Inc., a Tennessee corporation doing business as Highland Homes and a wholly owned subsidiary of Berkshire Hathaway.

"Assessment Area One Optional Redemption Subaccount" shall mean the subaccount so designated, established as a separate subaccount under the Assessment Area One Bond Redemption Account pursuant to Section 4.01(g) of this First Supplemental Trust Indenture.

"Assessment Area One Pledged Revenues" shall mean with respect to the Assessment Area One Bonds (a) all revenues received by the Issuer from Assessment Area One Special Assessments levied and collected from Assessment Area One, including, without limitation, amounts received from any foreclosure proceeding for the enforcement of collection of such Assessment Area One Special Assessments or from the issuance and sale of tax certificates with respect to such Assessment Area One Special Assessments, and (b) all moneys on deposit in the Funds and Accounts established under the Assessment Area One Indenture created and established with respect to or for the benefit of the Assessment Area One Bonds; provided, however, that Assessment Area One Pledged Revenues shall not include (A) any moneys transferred to the Assessment Area One Rebate Fund and investment earnings thereon, (B) moneys on deposit in the Assessment Area One Costs of Issuance Account of the Acquisition and Construction Fund, and (C) "special assessments" levied and collected by the Issuer under Section 190.022 of the Act for maintenance purposes or "maintenance assessments" levied and collected by the Issuer under Section 190.021(3) of the Act (it being expressly understood that the lien and pledge of the Assessment Area One Indenture shall not apply to any of the moneys described in the foregoing clauses (A), (B) and (C) of this proviso).

"Assessment Area One Prepayment Principal" shall mean the portion of a Prepayment corresponding to the principal amount of Assessment Area One Special Assessments being prepaid pursuant to Section 4.05 of this First Supplemental Trust Indenture or Assessment Area One Special Assessments collected as a result of an acceleration of the Assessment Area One

Special Assessments pursuant to Section 170.10, Florida Statutes, if such Assessment Area One Special Assessments are being collected through a direct billing method.

"Assessment Area One Prepayment Subaccount" shall mean the subaccount so designated, established as a separate subaccount under the Assessment Area One Bond Redemption Account pursuant to Section 4.01(g) of this First Supplemental Trust Indenture.

"Assessment Area One Project" shall mean the public infrastructure described on Exhibit A attached hereto benefitting Assessment Area One and referred to as "Phase 1."

"Assessment Area One Rebate Account" shall mean the Account so designated, established as a separate Account within the Rebate Fund pursuant to Section 4.01(j) of this First Supplemental Trust Indenture.

"Assessment Area One Reserve Account" shall mean the Account so designated, established as a separate Account within the Debt Service Reserve Fund pursuant to Section 4.01(f) of this First Supplemental Trust Indenture.

"Assessment Area One Reserve Requirement" or "Reserve Requirement" shall be (i) initially, an amount equal to the maximum annual debt service on the Assessment Area One Bonds as calculated from time to time; (ii) upon the occurrence of the Reserve Release Conditions #1, fifty percent (50%) of the maximum annual debt service on the Assessment Area One Bonds as calculated from time to time; and (iii) upon the occurrence of the Reserve Release Conditions #2, ten percent (10%) of the maximum annual debt service on the Assessment Area One Bonds as calculated from time to time. Upon satisfaction of the Reserve Release Conditions #1 or Reserve Release Conditions #2, as applicable, such excess amount shall be released from the Assessment Area One Reserve Account and transferred to the Assessment Area One Acquisition and Construction Account in accordance with the provisions of Sections 4.01(a) and 4.01(f) hereof. For the purpose of calculating the Assessment Area One Reserve Requirement, maximum annual debt service, fifty percent (50%) of the maximum annual debt service, or ten percent (10%) of the maximum annual debt service, as the case may be, shall be recalculated in connection with the extraordinary mandatory redemption described in Sections 3.01(b)(i) and 3.01(b)(iii) hereof (but not upon the optional or mandatory sinking fund redemption thereof) and such excess amount shall be released from the Assessment Area One Reserve Account and, other than as provided in the immediately preceding sentence, transferred to the Assessment Area One General Redemption Subaccount or the Assessment Area One Prepayment Subaccount as applicable, in accordance with the provisions of Sections 3.01(b)(i), 3.01(b)(iii), 4.01(f), 4.01(i) and 4.05(a) hereof. Amounts on deposit in the Assessment Area One Reserve Account may, upon final maturity or redemption of all Outstanding Assessment Area One Bonds be used to pay principal of and interest on the Assessment Area One Bonds at that time. Initially, the Assessment Area One Reserve Requirement shall be equal to \$_____.

"Assessment Area One Revenue Account" shall mean the Account so designated, established as a separate Account within the Revenue Fund pursuant to Section 4.01(b) of this First Supplemental Trust Indenture.

"Assessment Area One Sinking Fund Account" shall mean the Account so designated, established as a separate Account within the Debt Service Fund pursuant to Section 4.01(e) of this First Supplemental Trust Indenture.

"Assessment Area One Special Assessments" shall mean the Special Assessments levied on the assessable lands within Assessment Area One as a result of the Issuer's acquisition and/or construction of the Assessment Area One Project, corresponding in amount to the debt service on the Assessment Area One Bonds and designated as such in the methodology report relating thereto.

"Assessment Resolutions" shall mean Resolution Nos. 2022-27, 2022-28, 2022-36 and 2023-__ of the Issuer adopted on July 14, 2022, July 14, 2022, September 8, 2022 and _____, 2023, respectively, as amended and supplemented from time to time.

"Authorized Denomination" shall mean, with respect to the Assessment Area One Bonds, on the date of issuance in the denominations of \$5,000 and any integral multiple thereof; provided, however, if any initial Beneficial Owner (as defined in the Master Indenture) does not purchase at least \$100,000 of the Assessment Area One Bonds at the time of initial delivery of the Assessment Area One Bonds, such Beneficial Owner must either execute and deliver to the Issuer and the Underwriter on the date of delivery of the Assessment Area One Bonds the investor letter in the form attached hereto as Exhibit D or otherwise establish to the satisfaction of the Underwriter that such Beneficial Owner is an "accredited investor," as described in Rule 501(a) under Regulation D of the Securities Act of 1933, as amended.

"Collateral Assignment" shall mean that agreement wherein certain rights and material documents necessary to complete the development planned by Assessment Area One Landowner on the District Lands are collaterally assigned to the District as security for Assessment Area One Landowner's obligation to pay the Assessment Area One Special Assessments imposed against such lands which are within Assessment Area One subject to the Assessment Area One Special Assessments and owned by Assessment Area One Landowner from time to time.

"Completion Agreement" shall mean the Agreement between the District and Assessment Area One Landowner regarding the completion of certain improvements, dated [_____] __, 2023.

"Continuing Disclosure Agreement" shall mean the Continuing Disclosure Agreement for the benefit of the Beneficial Owners of the Assessment Area One Bonds, dated [_____] __, 2023, by and among the Issuer, the dissemination agent named therein, and the Assessment Area One Landowner, in connection with the issuance of the Assessment Area One Bonds.

"Declaration of Consent" shall mean the certain instrument executed by the Assessment Area One Landowner declaring consent to the jurisdiction of the District and the imposition of the Assessment Area One Special Assessments.

"District Manager" shall mean Governmental Management Services – Central Florida, LLC, and its successors and assigns.

"Engineer's Report" shall mean the Hickory Tree Community Development District Engineer's Report dated June 28, 2022, as supplemented by the [_____ dated _____] and each prepared by prepared by Dewberry Engineers Inc.

"Interest Payment Date" shall mean May 1 and November 1 of each year, commencing May 1, 2024.

"Majority Holders" means the Beneficial Owners or Owner of more than fifty percent (50%) in aggregate principal amount of the Outstanding Assessment Area One Bonds.

"Master Indenture" shall mean the Master Trust Indenture, dated as of [_____] 1, 2023, by and between the Issuer and the Trustee, as supplemented and amended with respect to matters pertaining solely to the Master Indenture or the Assessment Area One Bonds (as opposed to supplements or amendments relating to any Series of Bonds other than the Assessment Area One Bonds as specifically defined in this First Supplemental Trust Indenture).

"Paying Agent" shall mean U.S. Bank Trust Company, National Association, and its successors and assigns as Paying Agent hereunder.

"Prepayment" shall mean the payment by any owner of property of the amount of Assessment Area One Special Assessments encumbering its property, in whole or in part, prior to its scheduled due date, including optional prepayments. The term "Prepayment" also means any proceeds received as a result of accelerating and/or foreclosing the Assessment Area One Special Assessments. "Prepayments" shall include, without limitation, Assessment Area One Prepayment Principal.

"Project" shall mean all of the public infrastructure deemed necessary for the development of the District including, but not limited to, the Assessment Area One Project.

"Quarterly Redemption Date" shall mean each February 1, May 1, August 1, and November 1 of any calendar year.

"Redemption Price" shall mean the principal amount of any Assessment Area One Bond plus the applicable premium, if any payable upon redemption thereof pursuant to this First Supplemental Trust Indenture.

"Registrar" shall mean U.S. Bank Trust Company, National Association and its successors and assigns as Registrar hereunder.

"Regular Record Date" shall mean the fifteenth day (whether or not a Business Day) of the calendar month next preceding each Interest Payment Date or the date on which the principal of the Assessment Area One Bonds are to be paid.

"Reserve Release Conditions #1" shall mean collectively (i) all lots subject to the Assessment Area One Special Assessments have been developed and platted, as certified by the District Manager in writing and upon which the Trustee may conclusively rely, and (ii) there shall be no Events of Default under the Assessment Area One Indenture, all as certified by the District Manager in writing and upon which the Trustee may conclusively rely.

"Reserve Release Conditions #2" shall mean collectively (i) satisfaction of Reserve Release Conditions #1, (ii) all homes subject to the Assessment Area One Special Assessments have been built and have received a certificate of occupancy, (iii) all of the principal portion of the Assessment Area One Special Assessments has been assigned to such homes, and (iv) there shall be no Events of Default under the Assessment Area One Indenture, all as certified by the District Manager in writing and upon which the Trustee may conclusively rely.

"Resolution" shall mean, collectively, (i) Resolution No. 2022-26 of the Issuer adopted on July 14, 2022, pursuant to which the Issuer authorized the issuance of not exceeding \$53,090,000 aggregate principal amount of its Bonds to finance the construction or acquisition of the Project, and (ii) Resolution No. 2023-07 of the Issuer adopted on September 6, 2023 (the "Delegation Resolution"), pursuant to which the Issuer authorized, among other things, the issuance of the Assessment Area One Bonds to pay all or a portion of the costs of the planning, financing, acquisition, construction, equipping and installation of the Assessment Area One Project, specifying the details of the Assessment Area One Bonds and awarding the Assessment Area One Bonds to the purchasers of the Assessment Area One Bonds.

"Substantially Absorbed" means the date at least 75% of the principal portion of the Assessment Area One Special Assessments have been assigned to residential units within Assessment Area One that have received certificates of occupancy. The District shall present the Trustee with a certification that the Assessment Area One Special Assessments are Substantially Absorbed and the Trustee may rely conclusively upon such certification and shall have no duty to verify if the Assessment Area One Special Assessments are Substantially Absorbed.

"True-Up Agreement" shall mean the Agreement dated [_____] __, 2023, by and between the Issuer and the Assessment Area One Landowner relating to the true-up of Assessment Area One Special Assessments.

"Underwriter" shall mean FMSbonds, Inc., the underwriter of the Assessment Area One Bonds.

The words "hereof," "herein," "hereto," "hereby," and "hereunder" (except in the form of Assessment Area One Bonds), refer to the entire Assessment Area One Indenture.

Every "request," "requisition," "order," "demand," "application," "notice," "statement," "certificate," "consent," or similar action hereunder by the Issuer shall, unless the form or execution thereof is otherwise specifically provided, be in writing signed by the Chairperson or Vice Chairperson and the Treasurer or Assistant Treasurer or the Secretary or Assistant Secretary or Responsible Officer of the Issuer.

All words and terms importing the singular number shall, where the context requires, import the plural number and vice versa.

[END OF ARTICLE I]

ARTICLE II
THE ASSESSMENT AREA ONE BONDS

SECTION 2.01. Amounts and Terms of Assessment Area One Bonds; Issue of Assessment Area One Bonds. No Assessment Area One Bonds may be issued under this First Supplemental Trust Indenture except in accordance with the provisions of this Article and Articles II and III of the Master Indenture.

(a) The total principal amount of Assessment Area One Bonds that may be issued under this First Supplemental Trust Indenture is expressly limited to \$_____. The Assessment Area One Bonds shall be numbered consecutively from R-1 and upwards.

(b) Any and all Assessment Area One Bonds shall be issued substantially in the form attached hereto as Exhibit B, with such appropriate variations, omissions and insertions as are permitted or required by the Assessment Area One Indenture and with such additional changes as may be necessary or appropriate to conform to the provisions of the Resolution. The Issuer shall issue the Assessment Area One Bonds upon execution of this First Supplemental Trust Indenture and satisfaction of the requirements of Section 3.01 of the Master Indenture; and the Trustee shall, at the Issuer's request, authenticate such Assessment Area One Bonds and deliver them as specified in the request.

SECTION 2.02. Execution. The Assessment Area One Bonds shall be executed by the Issuer as set forth in the Master Indenture.

SECTION 2.03. Authentication. The Assessment Area One Bonds shall be authenticated as set forth in the Master Indenture. No Assessment Area One Bond shall be valid until the certificate of authentication shall have been duly executed by the Trustee, as provided in the Master Indenture.

SECTION 2.04. Purpose, Designation and Denominations of, and Interest Accruals on, the Assessment Area One Bonds.

(a) The Assessment Area One Bonds are being issued hereunder in order to provide funds for the purposes of (i) providing funds to pay all or a portion of the costs of the planning, financing, acquisition, construction, equipping and installation of the Assessment Area One Project, (ii) funding a deposit to the Assessment Area One Reserve Account in the amount of the Assessment Area One Reserve Requirement, (iii) paying a portion of the interest coming due on the Assessment Area One Bonds and (iv) paying the costs of issuance of the Assessment Area One Bonds. The Assessment Area One Bonds shall be designated "Hickory Tree Community Development District Special Assessment Bonds, Series 2023 (Assessment Area One Project)," and shall be issued as fully registered Bonds without coupons in Authorized Denominations.

(b) The Assessment Area One Bonds shall be dated as of the date of initial delivery. Interest on the Assessment Area One Bonds shall be payable on each Interest Payment Date to maturity or prior redemption. Interest on the Assessment Area One Bonds shall be payable from the most recent Interest Payment Date next preceding the date of authentication

thereof to which interest has been paid, unless the date of authentication thereof is a May 1 or November 1 to which interest has been paid, in which case from such date of authentication, or unless the date of authentication thereof is prior to May 1, 2024, in which case from the date of initial delivery or unless the date of authentication thereof is between a Record Date and the next succeeding Interest Payment Date, in which case from such Interest Payment Date.

(c) Except as otherwise provided in Section 2.07 of this First Supplemental Trust Indenture in connection with a book entry only system of registration of the Assessment Area One Bonds, the principal or Redemption Price of the Assessment Area One Bonds shall be payable in lawful money of the United States of America at the designated corporate trust office of the Paying Agent upon presentation of such Assessment Area One Bonds. Except as otherwise provided in Section 2.07 of this First Supplemental Trust Indenture in connection with a book entry only system of registration of the Assessment Area One Bonds, the payment of interest on the Assessment Area One Bonds shall be made on each Interest Payment Date to the Registered Owners of the Assessment Area One Bonds by check or draft drawn on the Paying Agent and mailed on the applicable Interest Payment Date to each Registered Owner as such Registered Owner appears on the Bond Register maintained by the Registrar as of the close of business on the Regular Record Date, at his address as it appears on the Bond Register. Any interest on any Assessment Area One Bond which is payable, but is not punctually paid or provided for on any Interest Payment Date (hereinafter called "Defaulted Interest") shall be paid to the Registered Owner in whose name the Assessment Area One Bond is registered at the close of business on a Special Record Date to be fixed by the Trustee, such date to be not more than fifteen (15) nor less than ten (10) days prior to the date of proposed payment. The Trustee shall cause notice of the proposed payment of such Defaulted Interest and the Special Record Date therefor to be sent by Electronic Means or mailed, first-class, postage-prepaid, to each Registered Owner of record as of the fifth (5th) day prior to such mailing, at his address as it appears in the Bond Register not less than ten (10) days prior to such Special Record Date. The foregoing notwithstanding, any Registered Owner of Assessment Area One Bonds in an aggregate principal amount of at least \$1,000,000 shall be entitled to have interest paid by wire transfer to such Registered Owner to the bank account number on file with the Paying Agent, upon requesting the same in a writing received by the Paying Agent at least fifteen (15) days prior to the relevant Record Date, which writing shall specify the bank, which shall be a bank within the continental United States, and bank account number to which interest payments are to be wired. Any such request for interest payments by wire transfer shall remain in effect until rescinded or changed, in a writing delivered by the Registered Owner to the Paying Agent, and any such rescission or change of wire transfer instructions must be received by the Paying Agent at least fifteen (15) days prior to the relevant Record Date.

SECTION 2.05. Debt Service on the Assessment Area One Bonds.

(a) The Assessment Area One Bonds will mature on May 1 in the years and in the principal amounts, and bear interest at the rates all set forth below, subject to the right of prior redemption in accordance with their terms.

<u>Year</u>	<u>Amount</u>	<u>Interest Rate</u>
	\$	%

(b) Interest on the Assessment Area One Bonds will be computed in all cases on the basis of a 360 day year of twelve 30 day months. Interest on overdue principal and, to the extent lawful, on overdue interest will be payable at the numerical rate of interest borne by the Assessment Area One Bonds on the day before the default occurred.

SECTION 2.06. Disposition of Assessment Area One Bond Proceeds. From the net proceeds of the Assessment Area One Bonds received by the Trustee in the amount of \$_____ (par amount of \$_____, [plus/minus [net] bond premium/original issue discount] of \$_____ and less underwriter's discount of \$_____ which is retained by the underwriter of the Assessment Area One Bonds):

(a) \$_____, which is an amount equal to the Assessment Area One Reserve Requirement, shall be deposited in the Assessment Area One Reserve Account of the Debt Service Reserve Fund;

(b) \$_____, shall be deposited into the Assessment Area One Interest Account and applied to pay interest coming due on the Assessment Area One Bonds through [May 1, 2024];

(c) \$_____, shall be deposited into the Assessment Area One Costs of Issuance Account of the Acquisition and Construction Fund for payment of the costs of issuing the Assessment Area One Bonds; and

(d) \$_____, shall be deposited into the Area One Acquisition and Construction Account of the Acquisition and Construction Fund which the Issuer shall cause to be applied only to the payment of costs of the Assessment Area One Project in accordance with Section 4.01(a) hereof, Article V of the Master Indenture and the terms of the Acquisition Agreement.

SECTION 2.07. Book-Entry Form of Assessment Area One Bonds. The Assessment Area One Bonds shall be issued as one fully registered bond for each maturity of Assessment Area One Bonds and deposited with The Depository Trust Company ("DTC"), New York, New York, which is responsible for establishing and maintaining records of ownership for its participants.

As long as the Assessment Area One Bonds are held in book-entry-only form, Cede & Co. shall be considered the Registered Owner for all purposes hereof and in the Master Indenture. The Assessment Area One Bonds shall not be required to be presented for payment. DTC shall be responsible for maintaining a book-entry-only system for recording the ownership interest of its participants ("DTC Participants") and other institutions that clear through or maintain a custodial relationship with a DTC Participant, either directly or indirectly ("Indirect

Participants"). The DTC Participants and Indirect Participants will be responsible for maintaining records with respect to the beneficial ownership interests of individual purchasers of the Assessment Area One Bonds ("Beneficial Owners").

Principal and interest on the Assessment Area One Bonds registered in the name of Cede & Co. prior to and at maturity shall be payable directly to Cede & Co. in care of DTC. Disbursal of such amounts to DTC Participants shall be the responsibility of DTC. Payments by DTC Participants to Indirect Participants, and by DTC Participants and Indirect Participants to Beneficial Owners shall be the responsibility of DTC Participants and Indirect Participants and not of DTC, the Trustee or the Issuer.

Individuals may purchase beneficial interests in Authorized Denominations in book-entry-only form, without certificated Assessment Area One Bonds, through DTC Participants and Indirect Participants.

During the period for which Cede & Co. is Registered Owner of the Assessment Area One Bonds, any notices to be provided to any Beneficial Owner will be provided to Cede & Co. DTC shall be responsible for notices to DTC Participants and DTC Participants shall be responsible for notices to Indirect Participants, and DTC Participants and Indirect Participants shall be responsible for notices to Beneficial Owners.

The Issuer and the Trustee, if appropriate, shall enter into a blanket letter of representations with DTC providing for such book-entry-only system. Such agreement may be terminated at any time by either DTC or the Issuer in accordance with the procedures of DTC. In the event of such termination, the Issuer shall select another securities depository and in that event, all references herein to DTC or Cede & Co., shall be deemed to be for reference to such successor. If the Issuer does not replace DTC, the Trustee will register and deliver to the Beneficial Owners replacement Assessment Area One Bonds in the form of fully registered Assessment Area One Bonds in accordance with the instructions from Cede & Co.

In the event DTC, any successor of DTC or the Issuer, but only in accordance with the procedures of DTC, elects to discontinue the book-entry only system, the Trustee shall deliver bond certificates in accordance with the instructions from DTC or its successor and after such time Assessment Area One Bonds may be exchanged for an equal aggregate principal amount of Assessment Area One Bonds in other Authorized Denominations upon surrender thereof at the designated corporate trust office of the Trustee.

SECTION 2.08. Appointment of Registrar and Paying Agent. The Issuer shall keep, at the designated corporate trust office of the Registrar, books (the "Bond Register") for the registration, transfer and exchange of the Assessment Area One Bonds, and hereby appoints U.S. Bank Trust Company, National Association, as its Registrar to keep such books and make such registrations, transfers, and exchanges as required hereby. U.S. Bank Trust Company, National Association hereby accepts its appointment as Registrar and its duties and responsibilities as Registrar hereunder. Registrations, transfers and exchanges shall be without charge to the Bondholder requesting such registration, transfer or exchange, but such Bondholder shall pay any taxes or other governmental charges on all registrations, transfers and exchanges.

The Issuer hereby appoints U.S. Bank Trust Company, National Association as Paying Agent for the Assessment Area One Bonds. U.S. Bank Trust Company, National Association hereby accepts its appointment as Paying Agent and its duties and responsibilities as Paying Agent hereunder.

SECTION 2.09. Conditions Precedent to Issuance of the Assessment Area One Bonds. In addition to complying with the requirements set forth in the Master Indenture in connection with the issuance of the Assessment Area One Bonds, all the Assessment Area One Bonds shall be executed by the Issuer for delivery to the Trustee and thereupon shall be authenticated by the Trustee and delivered to the Issuer or upon its order, but only upon the further receipt by the Trustee of:

- (a) Certified copies of the Assessment Resolutions;
- (b) A copy of the executed Master Indenture and an executed copy of this First Supplemental Trust Indenture;
- (c) Customary closing opinions of District Counsel and Bond Counsel;
- (d) A certificate of an Authorized Officer to the effect that, upon the authentication and delivery of the Assessment Area One Bonds, the Issuer will not be in default in the performance of the terms and provisions of the Master Indenture or this First Supplemental Trust Indenture;
- (e) Copies of executed investor letters in the form attached hereto as Exhibit D if such investor letter is required, as determined by the Underwriter; and
- (f) Executed copies of the Arbitrage Certificate, the True-Up Agreement, the Acquisition Agreement, Declaration of Consent, the Completion Agreement, the Continuing Disclosure Agreement and the Collateral Assignment.

Payment to the Trustee of the net proceeds of the Assessment Area One Bonds shall be conclusive evidence that the foregoing conditions have been fulfilled to the satisfaction of the Issuer and the Underwriter.

[END OF ARTICLE II]

ARTICLE III REDEMPTION OF ASSESSMENT AREA ONE BONDS

SECTION 3.01. Redemption Dates and Prices. The Assessment Area One Bonds shall be subject to redemption at the times and in the manner provided in Article VIII of the Master Indenture and in this Article III. All payments of the Redemption Price of the Assessment Area One Bonds shall be made on the dates hereinafter required. Except as otherwise provided in this Section 3.01, if less than all the Assessment Area One Bonds of a maturity are to be redeemed pursuant to an extraordinary mandatory redemption, the Trustee shall select the Assessment Area One Bonds or portions of the Assessment Area One Bonds to be redeemed by lot. Partial redemptions of Assessment Area One Bonds shall, to the extent possible, be made in such a manner that the remaining Assessment Area One Bonds held by each Bondholder shall be in Authorized Denominations, except for the last remaining Assessment Area One Bond.

The Assessment Area One Bonds are subject to redemption prior to maturity in the amounts, at the times and in the manner provided below. All payments of the Redemption Price of the Assessment Area One Bonds shall be made on the dates specified below. Upon any redemption of Assessment Area One Bonds other than in accordance with scheduled mandatory sinking fund redemption amounts, the Issuer shall cause to be recalculated and delivered to the Trustee revised mandatory sinking fund redemption amounts recalculated so as to amortize the Outstanding principal amount of Assessment Area One Bonds in substantially equal annual installments of principal and interest (subject to rounding to Authorized Denominations of principal) over the remaining term of the Assessment Area One Bonds. The mandatory sinking fund redemption amounts as so recalculated shall not result in an increase in the aggregate of the mandatory sinking fund redemption amounts for all Assessment Area One Bonds in any year. In the event of a redemption or purchase occurring less than forty-five (45) days prior to a date on which a mandatory sinking fund redemption amount is due, the foregoing recalculation shall not be made to the mandatory sinking fund redemption amounts due in the year in which such redemption occurs, but shall be made to the mandatory sinking fund redemption amounts for the immediately succeeding and subsequent years.

(a) Optional Redemption. The Assessment Area One Bonds maturing after May 1, 20__ may, at the option of the Issuer be called for redemption prior to maturity as a whole or in part, at any time, on or after May 1, 20__ (less than all Assessment Area One Bonds of a maturity to be selected by lot), at a Redemption Price equal to the principal amount of Assessment Area One Bonds to be redeemed, plus accrued interest from the most recent Interest Payment Date through which interest has been paid to the redemption date from moneys on deposit in the Assessment Area One Optional Redemption Subaccount of the Assessment Area One Bond Redemption Account. If such optional redemption shall be in part, the Issuer shall select such principal amount of Assessment Area One Bonds to be optionally redeemed from each maturity so that debt service on the remaining Outstanding Assessment Area One Bonds is substantially level.

(b) Extraordinary Mandatory Redemption in Whole or in Part. The Assessment Area One Bonds are subject to extraordinary mandatory redemption prior to

maturity by the Issuer in whole or in part, on any date (other than in the case of clause (i) below, which extraordinary mandatory redemption in part must occur on a Quarterly Redemption Date), at a Redemption Price equal to 100% of the principal amount of the Assessment Area One Bonds to be redeemed, plus interest accrued to the redemption date, as follows:

(i) from Assessment Area One Prepayment Principal deposited into the Assessment Area One Prepayment Subaccount of the Assessment Area One Bond Redemption Account following the payment in whole or in part of Assessment Area One Special Assessments on any assessable property within Assessment Area One in accordance with the provisions of Section 4.05(a) of this First Supplemental Trust Indenture, together with any excess moneys transferred by the Trustee from the Assessment Area One Reserve Account to the Assessment Area One Prepayment Subaccount as a result of such Assessment Area One Prepayment and pursuant to Sections 4.01(f) and 4.05(a) of this First Supplemental Trust Indenture. If such redemption shall be in part, the Issuer shall select such principal amount of Assessment Area One Bonds to be redeemed from each maturity so that debt service on the remaining Outstanding Assessment Area One Bonds is substantially level.

(ii) from moneys, if any, on deposit in the Funds, Accounts and subaccounts held by the Trustee hereunder (other than the Assessment Area One Rebate Fund and the Assessment Area One Acquisition and Construction Account) sufficient to pay and redeem all Outstanding Assessment Area One Bonds and accrued interest thereon to the redemption date or dates in addition to all amounts owed to Persons under the Master Indenture.

(iii) upon the Completion Date, from any funds remaining on deposit in the Assessment Area One Acquisition and Construction Account in accordance with the provisions of Section 4.01(a) hereof, not otherwise reserved to complete the Assessment Area One Project and transferred to the Assessment Area One General Redemption Subaccount of the Assessment Area One Bond Redemption Account, together with moneys deposited therein in accordance with the provisions of Section 4.01(a) hereof, as a result of the reduction of the Assessment Area One Reserve Requirement. If such redemption shall be in part, the Issuer shall select such principal amount of Assessment Area One Bonds to be redeemed from each maturity so that debt service on the remaining Outstanding Assessment Area One Bonds is substantially level.

(c) Mandatory Sinking Fund Redemption. The Assessment Area One Bonds maturing on May 1, 20__ are subject to mandatory sinking fund redemption from the moneys on deposit in the Assessment Area One Sinking Fund Account on May 1 in the years and in the mandatory sinking fund redemption amounts set forth below at a Redemption Price of 100% of their principal amount plus accrued interest to the date of redemption.

<u>Year</u>	<u>Mandatory Sinking Fund Redemption Amount</u>
	\$

*

* Maturity.

The Assessment Area One Bonds maturing on May 1, 20__ are subject to mandatory sinking fund redemption from the moneys on deposit in the Assessment Area One Sinking Fund Account on May 1 in the years and in the mandatory sinking fund redemption amounts set forth below at a Redemption Price of 100% of their principal amount plus accrued interest to the date of redemption.

<u>Year</u>	<u>Mandatory Sinking Fund Redemption Amount</u>
	\$

*

* Maturity

The Assessment Area One Bonds maturing on May 1, 20__ are subject to mandatory sinking fund redemption from the moneys on deposit in the Assessment Area One Sinking Fund Account on May 1 in the years and in the mandatory sinking fund redemption amounts set forth below at a Redemption Price of 100% of their principal amount plus accrued interest to the date of redemption.

<u>Year</u>	<u>Mandatory Sinking Fund Redemption Amount</u>	<u>Year</u>	<u>Mandatory Sinking Fund Redemption Amount</u>
	\$		\$

*

* Maturity

The Assessment Area One Bonds maturing on May 1, 20__ are subject to mandatory sinking fund redemption from the moneys on deposit in the Assessment Area One Sinking Fund Account on May 1 in the years and in the mandatory sinking fund redemption amounts set forth below at a Redemption Price of 100% of their principal amount plus accrued interest to the date of redemption.

<u>Year</u>	<u>Mandatory Sinking Fund Redemption Amount</u>	<u>Year</u>	<u>Mandatory Sinking Fund Redemption Amount</u>
	\$		\$

*

* Maturity

SECTION 3.02. Notice of Redemption. When required to redeem Assessment Area One Bonds under any provision of this First Supplemental Trust Indenture or directed to redeem Assessment Area One Bonds by the Issuer, the Trustee shall give or cause to be given to Registered Owners of the Assessment Area One Bonds to be redeemed, notice of the redemption, as set forth in Article VIII of the Master Indenture.

[END OF ARTICLE III]

ARTICLE IV
ESTABLISHMENT OF CERTAIN FUNDS AND ACCOUNTS;
ADDITIONAL COVENANTS OF THE ISSUER; PREPAYMENTS;
REMOVAL OF ASSESSMENT AREA ONE SPECIAL ASSESSMENT LIENS

SECTION 4.01. Establishment of Certain Funds and Accounts.

(a) The Trustee shall establish a separate account within the Acquisition and Construction Fund designated as the "Assessment Area One Acquisition and Construction Account." Net proceeds of the Assessment Area One Bonds shall initially be deposited into the Assessment Area One Acquisition and Construction Account in the amount set forth in Section 2.06 of this First Supplemental Trust Indenture, together with any moneys subsequently transferred or deposited thereto, including moneys transferred from the Assessment Area One Reserve Account after satisfaction of either the Reserve Release Conditions #1 or Reserve Release Conditions #2 as certified in writing by the District Manager and upon which the Trustee may conclusively rely, and such moneys shall be applied as set forth in this Section 4.01(a), Section 5.01 of the Master Indenture, the Acquisition Agreement and the Engineer's Report. Funds on deposit in the Assessment Area One Acquisition and Construction Account shall only be requested by the Issuer to be applied to the Costs of the Assessment Area One Project, subject to Section 4.01(f) herein. Upon satisfaction of the Reserve Release Conditions #1 and Reserve Release Conditions #2, the amount on deposit in the Assessment Area One Reserve Account in excess of the Assessment Area One Reserve Requirement, as applicable and as calculated by the District shall then be transferred by the Trustee to the Assessment Area One Acquisition and Construction Account, as directed in writing to the Trustee by the District Manager, upon consultation with the Consulting Engineer, and applied as provided in this Section 4.01(a).

Following the Completion Date for the Assessment Area One Project, all moneys remaining in the Assessment Area One Acquisition and Construction Account that have not been requisitioned within thirty (30) days after satisfaction of the Reserve Release Conditions #2, shall be transferred to the Assessment Area One General Redemption Subaccount, as directed in writing by the District Manager on behalf of the Issuer to the Trustee, to be applied as provided in Section 3.01(b)(iii) hereof. Notwithstanding the foregoing, the Assessment Area One Acquisition and Construction Account shall not be closed until the Reserve Release Conditions #2 shall have occurred and the excess funds from the Assessment Area One Reserve Account shall have been transferred to the Assessment Area One Acquisition and Construction Account, as directed in writing to the Trustee by the District Manager, and applied in accordance with this Section 4.01(a) or as otherwise provided in Section 4.01(f) hereof. The Trustee shall not be responsible for determining the amounts in the Assessment Area One Acquisition and Construction Account and subaccounts allocable to the Assessment Area One Project or any transfers made to such Accounts in accordance with direction from the District Manager.

The Trustee shall make no such transfers from the Assessment Area One Acquisition and Construction Account to the Assessment Area One General Redemption Subaccount if an Event of Default exists, with respect to the Assessment Area One Bonds of which the Trustee has actual knowledge as described in Section 11.06 of the Master Indenture. Except as provided in Section 3.01(b)(iii) and Section 5.05 hereof, only upon presentment to the Trustee of a properly

signed requisition in substantially the form attached hereto as Exhibit C, shall the Trustee withdraw moneys from the Assessment Area One Acquisition and Construction Account. After no funds remain in the Assessment Area One Acquisition and Construction Account, such Account shall be closed

Pursuant to the Master Indenture, the Trustee shall establish a separate account within the Acquisition and Construction Fund designated as the "Assessment Area One Costs of Issuance Account." Net proceeds of the Assessment Area One Bonds shall be deposited into the Assessment Area One Costs of Issuance Account in the amount set forth in Section 2.06 of this First Supplemental Trust Indenture. Upon presentment to the Trustee of a properly signed requisition in substantially the form attached hereto as Exhibit C, the Trustee shall withdraw moneys from the Assessment Area One Costs of Issuance Account to pay the costs of issuing the Assessment Area One Bonds. Six months after the issuance of the Assessment Area One Bonds, any moneys remaining in the Assessment Area One Costs of Issuance Account in excess of the amounts requested to be disbursed by the Issuer shall be deposited into the Assessment Area One Interest Account and the Assessment Area One Costs of Issuance Account shall be closed. Any deficiency in the amount allocated to pay the cost of issuing the Assessment Area One Bonds shall be paid from excess Assessment Area One Pledged Revenues on deposit in the Assessment Area One Revenue Account as provided in Section 4.02. After no funds remain therein, the Assessment Area One Costs of Issuance Account shall be closed.

(b) Pursuant to Section 6.03 of the Master Indenture, the Trustee shall establish a separate Account within the Revenue Fund designated as the "Assessment Area One Revenue Account." Assessment Area One Special Assessments (except for Prepayments of Assessment Area One Special Assessments which shall be identified as such by the Issuer to the Trustee and deposited in the Assessment Area One Prepayment Subaccount) shall be deposited by the Trustee into the Assessment Area One Revenue Account which shall be applied as set forth in Section 6.03 of the Master Indenture and Section 4.02 of this First Supplemental Trust Indenture. The Trustee may conclusively rely that unless expressly indicated in writing by the District as a Prepayment upon deposit thereof with the Trustee, payments of Assessment Area One Special Assessments otherwise received by the Trustee are to be deposited into the Assessment Area One Revenue Account.

(c) [RESERVED].

(d) Pursuant to Section 6.04 of the Master Indenture and Section 4.02 of this First Supplemental Trust Indenture, the Trustee shall establish a separate Account within the Debt Service Fund designated as the "Assessment Area One Interest Account." Moneys deposited into the Assessment Area One Interest Account pursuant to Section 6.04 of the Master Indenture and Sections 2.06 and 4.02 of this First Supplemental Trust Indenture, shall be applied for the purposes provided therein and used to pay interest on the Assessment Area One Bonds.

(e) Pursuant to Section 6.04 of the Master Indenture, the Trustee shall establish a separate account within the Debt Service Fund designated as the "Assessment Area One Sinking Fund Account." Moneys shall be deposited into the Assessment Area One Sinking Fund Account as provided in Section 6.04 of the Master Indenture and Section 4.02 of this First

Supplemental Trust Indenture, and applied for the purposes provided therein and in Section 3.01(c) of this First Supplemental Trust Indenture.

(f) Pursuant to Section 6.05 of the Master Indenture, the Trustee shall establish a separate Account within the Debt Service Reserve Fund designated as the "Assessment Area One Reserve Account." Net proceeds of the Assessment Area One Bonds shall be deposited into the Assessment Area One Reserve Account in the amount set forth in Section 2.06 of this First Supplemental Trust Indenture, and such moneys, together with any other moneys deposited into the Assessment Area One Reserve Account shall be applied for the purposes provided in the Master Indenture and in this Section 4.01(f) and Section 4.05 of this First Supplemental Trust Indenture. Notwithstanding any provisions in the Master Indenture to the contrary, the Issuer covenants not to substitute the cash and Investment Securities on deposit in the Assessment Area One Reserve Account with a Debt Service Reserve Insurance Policy or a Debt Service Reserve Letter of Credit. Except as provided in the next paragraph, all investment earnings on moneys in the Assessment Area One Reserve Account shall remain on deposit therein.

[On each March 15 and September 15 (or, if such date is not a Business Day, on the Business Day next preceding such day), the Trustee shall determine the amount on deposit in the Assessment Area One Reserve Account and transfer any excess therein above the Assessment Area One Reserve Requirement resulting from investment earnings to the Assessment Area One Revenue Account in accordance with Section 4.02 hereof.]

Subject to the provisions of Section 4.05 hereof, on any date the Issuer receives notice from the District Manager that a landowner wishes to prepay its Assessment Area One Special Assessments relating to the benefited property of such landowner within Assessment Area One, or as a result of a mandatory true-up payment, the Issuer shall, or cause the District Manager, on behalf of the Issuer, to calculate the principal amount of such Prepayment taking into account a credit against the amount of Assessment Area One Prepayment Principal due by the amount of money in the Assessment Area One Reserve Account that will exceed the Assessment Area One Reserve Requirement for the Assessment Area One Bonds, taking into account the proposed Prepayment. Such excess shall be transferred to the Assessment Area One Prepayment Subaccount of the Assessment Area One Bond Redemption Account, as a result of such Prepayment. The District Manager, on behalf of the Issuer, shall make such calculation within ten (10) Business Days after such Prepayment and shall instruct the Trustee in writing to transfer such amount of credit given to the respective landowner from the Assessment Area One Reserve Account to the Assessment Area One Prepayment Subaccount of the Assessment Area One Bond Redemption Account to be used for the extraordinary mandatory redemption of the Assessment Area One Bonds in accordance with Section 3.01(b)(i) hereof. The Trustee is authorized to make such transfers and has no duty to verify such calculations. Notwithstanding any of the foregoing, amounts on deposit in the Assessment Area One Reserve Account shall be transferred by the Trustee, in the amounts directed in writing by the Majority Holders of the Assessment Area One Bonds to the Assessment Area One General Redemption Subaccount, if as a result of the application of Article X of the Master Indenture, the proceeds received from lands sold subject to the Assessment Area One Special Assessments and applied to redeem a portion of the Assessment Area One Bonds is less than the principal amount of Assessment Area One Bonds indebtedness attributable to such lands.

Notwithstanding the foregoing, upon satisfaction of the Reserve Release Conditions #1 and #2, the Trustee shall deposit such excess as directed by the District Manager in writing on deposit in the Assessment Area One Reserve Account to the Assessment Area One Acquisition and Construction Account and pay such amount as designated in a requisition in the form attached hereto as Exhibit C to the Issuer submitted by the Assessment Area One Landowner within thirty (30) days of such transfer which requisition shall be executed by the Issuer and the Consulting Engineer. Such payment is authorized notwithstanding that the Completion Date might have been declared provided the Assessment Area One Landowner can establish, to the satisfaction of the Consulting Engineer, Costs of the Assessment Area One Project that were not paid from moneys initially deposited in the Assessment Area One Acquisition and Construction Account. In the event that there are no unreimbursed costs to pay to the Assessment Area One Landowner, such excess moneys transferred from the Assessment Area One Reserve Account to the Assessment Area One Acquisition and Construction Account shall be deposited into the Assessment Area One General Redemption Subaccount of the Assessment Area One Bond Redemption Account upon direction to the Trustee by the District. If no completed requisition as provided in this section is submitted to the Trustee within thirty (30) days of moneys having been transferred from the Assessment Area One Reserve Account to the Assessment Area One Acquisition and Construction Account as a result of the satisfaction of the Reserve Release Conditions #1 and #2, such excess moneys in the Assessment Area One Acquisition and Construction Account shall then be transferred by the Trustee to the Assessment Area One General Redemption Subaccount and applied to the redemption of Assessment Area One Bonds as provided in Section 4.01(a) hereinabove.

In addition, and together with the moneys transferred from the Assessment Area One Reserve Account pursuant to this paragraph, if the amount on deposit in the Assessment Area One General Redemption Subaccount is not sufficient to redeem a principal amount of the Assessment Area One Bonds in an Authorized Denomination, the Trustee is authorized to withdraw amounts from the Assessment Area One Revenue Account to round up the amount in the Assessment Area One General Redemption Subaccount to the nearest Authorized Denomination. Notwithstanding the foregoing, no transfers from the Assessment Area One Revenue Account shall be made to pay interest on and/or principal of the Assessment Area One Bonds for the redemption pursuant to Section 3.01(b)(iii) if as a result the deposits required under Section 4.02 FIRST through FIFTH cannot be made in full.

(g) Pursuant to Section 6.06 of the Master Indenture, the Trustee shall establish a separate Series Bond Redemption Account within the Bond Redemption Fund designated as the "Assessment Area One Bond Redemption Account" and within such Account, an "Assessment Area One General Redemption Subaccount," an "Assessment Area One Optional Redemption Subaccount," and an "Assessment Area One Prepayment Subaccount." Except as otherwise provided in this First Supplemental Trust Indenture regarding Prepayments or in connection with the optional redemption of the Assessment Area One Bonds, moneys to be deposited into the Assessment Area One Bond Redemption Account as provided in Section 6.06 of the Master Indenture, shall be deposited to the Assessment Area One General Redemption Subaccount.

(h) Moneys that are deposited into the Assessment Area One General Redemption Subaccount (including all earnings on investments held therein) shall be used to call for the extraordinary mandatory redemption (i) in whole, pursuant to Section 3.01(b)(ii) hereof, the

Outstanding amount of Assessment Area One Bonds, or (ii) in whole or in part pursuant to Section 3.01(b)(iii) hereof.

(i) Moneys in the Assessment Area One Prepayment Subaccount (including all earnings on investments held in such Assessment Area One Prepayment Subaccount) shall be accumulated therein to be used to call for redemption pursuant to Section 3.01(b)(i) hereof an amount of Assessment Area One Bonds equal to the amount of money transferred to the Assessment Area One Prepayment Subaccount of the Assessment Area One Bond Redemption Account for the purpose of such extraordinary mandatory redemption on the dates and at the price provided in such Section 3.01(b)(i) hereof. In addition, and together with the moneys transferred from the Assessment Area One Reserve Account pursuant to paragraph (f) above, if the amount on deposit in the Assessment Area One Prepayment Subaccount is not sufficient to redeem a principal amount of the Assessment Area One Bonds in an Authorized Denomination, the Trustee upon written direction from the Issuer, shall be authorized to withdraw amounts from the Assessment Area One Revenue Account to deposit to the Assessment Area One Prepayment Subaccount to round-up the amount to the nearest Authorized Denomination. Notwithstanding the foregoing, no transfers from the Assessment Area One Revenue Account shall be directed by the Issuer to pay interest on and/or principal of the Assessment Area One Bonds for the redemption pursuant to Section 3.01(b)(i) if as a result the deposits required under Section 4.02 FIRST through FIFTH cannot be made in full.

(j) The Issuer hereby directs the Trustee to establish a separate account in the Rebate Fund designated as the "Assessment Area One Rebate Account." Moneys shall be deposited into the Assessment Area One Rebate Account, as provided in the Arbitrage Certificate and applied for the purposes provided therein.

(k) Moneys on deposit in the Assessment Area One Optional Redemption Subaccount shall be used to optionally redeem all or a portion of the Assessment Area One Bonds pursuant to Section 3.01(a) hereof.

SECTION 4.02. Assessment Area One Revenue Account. The Trustee shall transfer from amounts on deposit in the Assessment Area One Revenue Account to the Funds and Accounts designated below, the following amounts, at the following times and in the following order of priority:

FIRST, upon receipt but no later than the Business Day next preceding each Interest Payment Date, commencing May 1, 2024, to the Assessment Area One Interest Account of the Debt Service Fund, an amount equal to the interest on the Assessment Area One Bonds becoming due on the next succeeding Interest Payment Date, less any amount on deposit in the Assessment Area One Interest Account not previously credited;

SECOND, no later than the Business Day next preceding each May 1, commencing May 1, 2025, to the Assessment Area One Sinking Fund Account, an amount equal to the principal amount of Assessment Area One Bonds subject to sinking fund redemption on such May 1, less any amount on deposit in the Assessment Area One Sinking Fund Account not previously credited;

THIRD, upon receipt but no later than the Business Day next preceding each Interest Payment Date while Assessment Area One Bonds remain Outstanding, to the Assessment Area One Reserve Account, an amount equal to the amount, if any, which is necessary to make the amount on deposit therein equal to the Reserve Requirement for the Assessment Area One Bonds;

FOURTH, notwithstanding the foregoing, at any time the Assessment Area One Bonds are subject to redemption on a date which is not a May 1 or November 1 Interest Payment Date, the Trustee shall be authorized to transfer to the Assessment Area One Interest Account, the amount necessary to pay interest on the Assessment Area One Bonds subject to redemption on such date; and

FIFTH, subject to the foregoing paragraphs, the balance of any moneys remaining after making the foregoing deposits shall be first deposited into the Assessment Area One Costs of Issuance Account upon the written request of the Issuer to cover any deficiencies in the amount allocated to pay the cost of issuing the Assessment Area One Bonds and next, any balance in the Assessment Area One Revenue Account shall remain on deposit in such Assessment Area One Revenue Account, unless needed to be transferred to the Assessment Area One Prepayment Subaccount for the purposes of rounding the principal amount of an Assessment Area One Bond subject to extraordinary mandatory redemption pursuant to Sections 4.01(f) or 4.01(i) hereof to an Authorized Denomination, or unless pursuant to the Arbitrage Certificate, it is necessary to make a deposit into the Assessment Area One Rebate Fund, in which case, the Issuer shall direct the Trustee to make such deposit thereto.

In addition to a redemption of Assessment Area One Bonds from Prepayments on deposit in the Assessment Area One Prepayment Subaccount, the Trustee is further authorized, upon written direction from the Issuer, to transfer from the Assessment Area One Revenue Account to the Assessment Area One General Redemption Subaccount sufficient funds to cause the redemption of the next closest Authorized Denomination of Assessment Area One Bonds, as provided in Section 4.01(f) hereof.

SECTION 4.03. Power to Issue Assessment Area One Bonds and Create Lien The Issuer is duly authorized under the Act and all applicable laws of the State to issue the Assessment Area One Bonds, to execute and deliver the Assessment Area One Indenture and to pledge the Assessment Area One Pledged Revenues for the benefit of the Assessment Area One Bonds to the extent set forth herein. The Assessment Area One Pledged Revenues are not and shall not be subject to any other lien senior to or on a parity with the lien created in favor of the Assessment Area One Bonds, except as otherwise permitted under the Master Indenture and in Section 5.04 hereof. The Assessment Area One Bonds and the provisions of the Assessment Area One Indenture are and will be valid and legally enforceable obligations of the Issuer in accordance with their respective terms. The Issuer shall, at all times, to the extent permitted by law, defend, preserve and protect the pledge created by the Assessment Area One Indenture and all the rights of the Holders of the Assessment Area One Bonds under the Assessment Area One Indenture against all claims and demands of all persons whomsoever.

SECTION 4.04. Assessment Area One Project to Conform to Engineer's Report.
Simultaneously with the issuance of the Assessment Area One Bonds, the Issuer will promptly proceed to construct and/or acquire the Assessment Area One Project, as described in Exhibit A hereto and in the Engineer's Report relating thereto, all pursuant to the terms and provisions of the Acquisition Agreement.

SECTION 4.05. Prepayments; Removal of Assessment Area One Special Assessment Liens.

(a) At any time any owner of property subject to the Assessment Area One Special Assessments may, at its option, or as a result of acceleration of the Assessment Area One Special Assessments because of non-payment thereof, shall, or by operation of law, require the Issuer to reduce or release and extinguish the lien upon its property by virtue of the levy of the Assessment Area One Special Assessments by paying or causing there to be paid, to the Issuer all or a portion of the Assessment Area One Special Assessment, which shall constitute Assessment Area One Prepayment Principal, plus, except as provided below, accrued interest to the next succeeding Quarterly Redemption Date (or the first succeeding Quarterly Redemption Date that is at least forty-five (45) days after such Prepayment, if such Prepayment is made within 45 calendar days before the next succeeding Quarterly Redemption Date, as the case may be), attributable to the property subject to Assessment Area One Special Assessments owned by such owner. To the extent that such Prepayments are to be used to redeem Assessment Area One Bonds pursuant to Section 3.01(b)(i) hereof, in the event the amount on deposit in the Assessment Area One Reserve Account will exceed the Assessment Area One Reserve Requirement for the Assessment Area One Bonds as a result of a Prepayment in accordance with this Section 4.05(a) and the resulting extraordinary mandatory redemption in accordance with Section 3.01(b)(i) of this First Supplemental Trust Indenture of Assessment Area One Bonds, the excess amount shall be transferred from the Assessment Area One Reserve Account to the Assessment Area One Prepayment Subaccount, as a credit against the Assessment Area One Prepayment Principal otherwise required to be paid by the owner of such lot or parcel, upon written instructions of the Issuer to the Trustee together with a certificate of a Responsible Officer of the Issuer, upon which the Trustee may conclusively rely, stating that, after giving effect to such transfers sufficient moneys will be on deposit in the Assessment Area One Reserve Account to equal or exceed the Assessment Area One Reserve Requirement.

(b) Upon receipt of Assessment Area One Prepayment Principal as described in paragraph (a) above, subject to satisfaction of the conditions set forth therein, the Issuer shall immediately pay the amount so received to the Trustee, and the Issuer shall take such action as is necessary to record in the official improvement lien book of the District that the Assessment Area One Special Assessment has been paid in whole or in part and that such Assessment Area One Special Assessment lien is thereby reduced, or released and extinguished, as the case may be.

The Trustee may conclusively rely on the Issuer's determination of what moneys constitute Prepayments. The Trustee shall calculate the amount available for the extraordinary mandatory redemption of the applicable Assessment Area One Bonds pursuant to Section 3.01(b)(i) forty-five (45) days prior to each Quarterly Redemption Date.

[END OF ARTICLE IV]

ARTICLE V
COVENANTS AND DESIGNATIONS OF THE ISSUER

SECTION 5.01. Collection of Assessment Area One Special Assessments. The Assessment Area One Special Assessments levied for each full year on platted lots shall be collected pursuant to the uniform method provided for in Sections 197.3632 and 197.3635 Florida Statutes, (the "Uniform Method") unless the District determines that it is in its best interests to collect directly. The Assessment Area One Special Assessments levied on unplatted lots or lands shall be billed and collected directly by the District pursuant to the Act and Chapters 170 and 197, Florida Statutes, and not pursuant to the Uniform Method unless the District determines that it is in its best interests to do so. Prior to an Event of Default, the election to collect and enforce Assessment Area One Special Assessments in any year pursuant to any one method shall not, to the extent permitted by law, preclude the District from electing to collect and enforce Assessment Area One Special Assessments pursuant to any other method permitted by law in any subsequent year. Following an Event of Default, Assessment Area One Special Assessments levied on platted lots shall be collected pursuant to the Uniform Method and Assessment Area One Special Assessments levied on unplatted lots or lands shall be billed and collected directly by the District pursuant to the Act and Chapters 170 and 197, Florida Statutes, and not pursuant to the Uniform Method, in each case unless the Trustee, acting at the direction of the Majority Holders of the Assessment Area One Bonds Outstanding, provides written consent/direction to a different method of collection. All Assessment Area One Special Assessments that are billed and collected directly by the District and not via the Uniform Method shall be due and payable by the landowner no later than thirty (30) days prior to each Interest Payment Date; provided, however, that such Assessment Area One Special Assessments shall not be deemed to be delinquent unless and until they are not paid by the applicable Interest Payment Date with respect to which they have been billed. The assessment methodology shall not be materially amended without the written consent of the Majority Holders.

SECTION 5.02. Continuing Disclosure. Contemporaneously with the execution and delivery hereof, the Issuer and the Assessment Area One Landowner has executed and delivered a Continuing Disclosure Agreement in order to assist the Underwriter in complying with the requirements of Rule 15c2-12 promulgated under the Securities and Exchange Act of 1934. The Issuer covenants and agrees to comply with the provisions of the Continuing Disclosure Agreement applicable to it; however, as set forth therein, failure to so comply shall not constitute an Event of Default hereunder, but shall instead be enforceable by mandamus or any other means of specific performance.

SECTION 5.03. Investment of Funds and Accounts. The provisions of Section 7.02 of the Master Indenture shall apply to the investment and reinvestment of moneys in the Funds, Accounts and subaccounts therein created hereunder.

SECTION 5.04. Additional Bonds. The Issuer covenants not to issue any other Bonds or other debt obligations secured by the Assessment Area One Special Assessments. In addition, the Issuer covenants not to issue any other Bonds or debt obligations for capital projects, secured by Special Assessments on the assessable lands within the District that are subject to the Assessment Area One Special Assessments, until the Assessment Area One

Special Assessments are Substantially Absorbed. The District shall present the Trustee with a certification that the Assessment Area One Special Assessments are Substantially Absorbed and the Trustee may rely conclusively upon such certification and shall have no duty to verify if the Assessment Area One Special Assessments are Substantially Absorbed. In the absence of such written certification, the Trustee is entitled to assume that the Assessment Area One Special Assessments have not been Substantially Absorbed. Such covenant shall not prohibit the Issuer from issuing refunding Bonds or any Bonds or other obligations secured by Special Assessments levied on District Lands outside of Assessment Area One, or to finance any other capital project that is necessary to remediate any natural disaster, catastrophic damage or failure with respect to the Assessment Area One Project.

SECTION 5.05. Acknowledgement Regarding the Moneys in the Assessment Area One Acquisition and Construction Account Following an Event of Default

In accordance with the provisions of the Assessment Area One Indenture, the Assessment Area One Bonds are payable solely from the Assessment Area One Pledged Revenues and any other moneys held by the Trustee under the Assessment Area One Indenture for such purpose. Anything in the Assessment Area One Indenture to the contrary notwithstanding, the Issuer hereby acknowledges that, the Assessment Area One Pledged Revenues include, without limitation, all amounts on deposit in the Assessment Area One Acquisition and Construction Account of the Acquisition and Construction Fund then held by the Trustee, and upon the occurrence of an Event of Default with respect to the Assessment Area One Bonds, (i) the Assessment Area One Pledged Revenues may not be used by the Issuer (whether to pay costs of the Assessment Area One Project or otherwise) without the consent of the Majority Holders and (ii) the Assessment Area One Pledged Revenues may be used by the Trustee, at the direction or with the approval of the Majority Holders, to pay costs and expenses incurred in connection with the pursuit of remedies under the Assessment Area One Indenture, provided, however notwithstanding anything herein to the contrary the Trustee is also authorized to utilize the Assessment Area One Pledged Revenues to pay fees and expenses as provided in Section 10.12 of the Master Indenture.

[END OF ARTICLE V]

ARTICLE VI
THE TRUSTEE; THE PAYING AGENT AND REGISTRAR

SECTION 6.01. Acceptance of Trust. The Trustee accepts and agrees to execute the trusts hereby created and agrees to perform such trusts upon the terms and conditions set forth in the Assessment Area One Indenture. The Trustee agrees to act as Paying Agent, Registrar and Authenticating Agent for the Assessment Area One Bonds.

SECTION 6.02. Trustee's Duties. The Trustee shall not be responsible in any manner for the due execution of this First Supplemental Trust Indenture by the Issuer or for the recitals contained herein (except for the certificate of authentication on the Assessment Area One Bonds), all of which are made solely by the Issuer. Nothing contained herein shall limit the rights, benefits, privileges, protection and entitlement inuring to the Trustee under the Master Indenture.

[END OF ARTICLE VI]

**ARTICLE VII
MISCELLANEOUS PROVISIONS**

SECTION 7.01. Interpretation of First Supplemental Trust Indenture. This First Supplemental Trust Indenture amends and supplements the Master Indenture with respect to the Assessment Area One Bonds, and all of the provisions of the Master Indenture, to the extent not inconsistent herewith, are incorporated in this First Supplemental Trust Indenture by reference. To the maximum extent possible, the Master Indenture and the First Supplemental Trust Indenture shall be read and construed as one document.

SECTION 7.02. Amendments. Any amendments to this First Supplemental Trust Indenture shall be made pursuant to the provisions for amendment contained in the Master Indenture.

SECTION 7.03. Counterparts. This First Supplemental Trust Indenture may be executed in any number of counterparts, each of which when so executed and delivered shall be an original; but such counterparts shall together constitute but one and the same instrument.

SECTION 7.04. Appendices and Exhibits. Any and all schedules, appendices or exhibits referred to in and attached to this First Supplemental Trust Indenture are hereby incorporated herein and made a part of this First Supplemental Trust Indenture for all purposes.

SECTION 7.05. Payment Dates. In any case in which an Interest Payment Date or the maturity date of the Assessment Area One Bonds or the date fixed for the redemption of any Assessment Area One Bonds shall be other than a Business Day, then payment of interest, principal or Redemption Price need not be made on such date but may be made on the next succeeding Business Day, with the same force and effect as if made on the due date, and no interest on such payment shall accrue for the period after such due date if payment is made on such next succeeding Business Day.

SECTION 7.06. No Rights Conferred on Others. Nothing herein contained shall confer any right upon any Person other than the parties hereto and the Holders of the Assessment Area One Bonds, and no other person is intended to be a third party beneficiary hereof to be entitled to assert or preserve any claim hereunder.

[REMAINDER OF PAGE INTENTIONALLY LEFT BLANK – SIGNATURE PAGE FOLLOWS]

IN WITNESS WHEREOF, Hickory Tree Community Development District has caused this First Supplemental Trust Indenture to be executed by the Chairperson of its Board of Supervisors and its corporate seal to be hereunto affixed and attested by the Secretary of its Board of Supervisors and U.S. Bank Trust Company, National Association has caused this First Supplemental Trust Indenture to be executed by one of its authorized signatories, all as of the day and year first above written.

[SEAL]

Attest:

By: _____
Name: Jill Burns
Title: Secretary, Board of Supervisors

**HICKORY TREE COMMUNITY
DEVELOPMENT DISTRICT**

By: _____
Name: Milton Andrade
Title: Chairperson, Board of Supervisors

**U.S. BANK TRUST COMPANY,
NATIONAL ASSOCIATION,**
as Trustee, Paying Agent and Registrar

By: _____
Name: Scott A. Schuhle
Title: Vice President

EXHIBIT A
DESCRIPTION OF ASSESSMENT AREA ONE PROJECT

The Assessment Area One Project includes, but is not limited to, "Phase 1" of the public improvements described in the table below from the [Hickory Tree Community Development District Engineer's Report dated June 28, 2022], and prepared by Dewberry Engineers Inc.

<u>Infrastructure</u>					Subtotals
Number of Lots				797	
LF Roadway	<u>LF Cost</u>	<u>Lot Cost</u>	<u>Misc</u>	31696.94	
Roadway Length in Miles				6.00	
Offsite Improvements (1)(5)(7)(10)	\$ 126.50				\$ 4,009,662.91
Stormwater Management (1)(2)(3)(5)(6)(7)(10)					\$ 10,459,990.20
Mass Grading and Master Stormwater Drainage	\$ 245.00			\$ 7,765,750.30	
Roadway Drainage	\$ 85.00			\$ 2,694,239.90	
Utilities (Water, Sewer, & Reuse) (1)(5)(7)(9)(10)					\$ 7,714,842.10
Water	\$ 62.50			\$ 1,981,058.75	
Reuse	\$ 42.50			\$ 1,347,119.95	
Gravity Sewer	\$ 110.00			\$ 3,486,663.40	
Lift Station & Force mains			\$ 900,000.00	\$ 900,000.00	
Electrical (1)(5)(7)(9)(10)					\$ 2,116,999.51
Street Lighting	\$ 16.50			\$ 522,999.51	
Electrical Distribution		\$ 2,000.00		\$ 1,594,000.00	
Roadway (1)(4)(5)(7)(10)	\$ 150.00				\$ 4,754,541.00
Entry Feature (1)(7)(8)(9)(10)			\$ 220,000.00		\$ 220,000.00
Parks and Amenities (1)(7)(10)		\$ 2,200.00			\$ 1,753,400.00
SUBTOTAL CONSTRUCTION					\$ 31,029,435.72
General Consulting (Engr & Legal) @ 10%					\$ 3,102,943.57
Contingency @ 20%					\$ 6,826,475.86
TOTAL					\$ 40,958,855.15

DATE: 6/21/2022

1. Infrastructure consists of public roadway improvements, Stormwater management facilities, master sanitary sewer lift station and utilities, entry feature, landscaping and signage, and public neighborhood parks, all of which will be located on land owned by or subject to a permanent easement in favor of the District or another governmental entity.
2. Excludes grading of each lot in conjunction with home construction, which will be provided by home builder. Does not include the cost of transportation of fill for use of private lots.
3. Includes Stormwater pond excavation.
4. Includes sub-grade, base, asphalt paving, curbing, and civil/site engineering.
5. Includes subdivision infrastructure and civil/site engineering.
6. Stormwater does not include grading associated with building pads.
7. Estimates are based on 2022 costs.

8. Includes entry features, signage, hardscape, landscape, irrigation and buffer fencing.
9. CDD will enter into a Lighting Agreement with OUC for the streetlight poles and lighting service. Includes only the incremental cost of undergrounding and installation of streetlights.
10. The costs associated with the infrastructure are a master cost and is effectively shared by the entire project (All phases).

Source: Hickory Tree Community Development District Engineer's Report dated June 28, 2022, prepared by Dewberry Engineers Inc.

EXHIBIT B

[FORM OF ASSESSMENT AREA ONE BOND]

R-__

\$ _____

**UNITED STATES OF AMERICA
STATE OF FLORIDA**

**HICKORY TREE COMMUNITY DEVELOPMENT DISTRICT
SPECIAL ASSESSMENT BOND, SERIES 2023
(ASSESSMENT AREA ONE PROJECT)**

<u>Interest Rate</u> _____ %	<u>Maturity Date</u> May 1, 20__	<u>Date of Original Issuance</u> _____, 2023	<u>CUSIP</u> _____
---------------------------------	-------------------------------------	---	-----------------------

Registered Owner: CEDE & CO.

Principal Amount:

KNOW ALL PERSONS BY THESE PRESENTS that the Hickory Tree Community Development District (the "Issuer"), for value received, hereby promises to pay to the Registered Owner shown above or registered assigns, on the Maturity Date set forth above, from the sources hereinafter mentioned, the Principal Amount set forth above (with interest thereon at the Interest Rate per annum set forth above, computed on 360-day year of twelve 30-day months). Principal of and interest on this Bond are payable by U.S. Bank Trust Company, National Association, in Fort Lauderdale, Florida, as paying agent (said U.S. Bank Trust Company, National Association and/or any bank or trust company to become successor paying agent being herein called the "Paying Agent") made payable to the Registered Owner and mailed on each Interest Payment Date commencing May 1, 2024, to the address of the Registered Owner as such name and address shall appear on the registry books of the Issuer maintained by U.S. Bank Trust Company, National Association, as Registrar (said U.S. Bank Trust Company, National Association and any successor Registrar being herein called the "Registrar") at the close of business on the fifteenth day of the calendar month preceding each Interest Payment Date or the date on which the principal of a Bond is to be paid (the "Record Date"), provided however presentation is not required for payment while the Assessment Area One Bonds are registered in book-entry only form. Such interest shall be payable from the most recent Interest Payment Date next preceding the date of authentication hereof to which interest has been paid, unless the date of authentication hereof is a May 1 or November 1 to which interest has been paid, in which case from the date of authentication hereof, or unless such date of authentication is prior to May 1, 2024, in which case from the date of initial delivery, or unless the date of authentication hereof is between a Record Date and the next succeeding Interest Payment Date, in which case from such Interest Payment Date. Any such interest not so punctually paid or duly provided for shall forthwith cease to be payable to the Registered Owner on such Record Date and may be paid to the person in whose name this Bond is registered at the close of business on a Special Record Date for the payment of such defaulted interest to be fixed by the Paying Agent, notice whereof shall be given to

Bondholders of record as of the fifth (5th) day prior to such mailing, at their registered addresses, not less than ten (10) days prior to such Special Record Date, or may be paid, at any time in any other lawful manner, as more fully provided in the Assessment Area One Indenture (defined below). Any capitalized term used in this Bond and not otherwise defined shall have the meaning ascribed to such term in the Assessment Area One Indenture.

THE ASSESSMENT AREA ONE BONDS ARE LIMITED OBLIGATIONS OF THE ISSUER PAYABLE SOLELY OUT OF THE ASSESSMENT AREA ONE PLEDGED REVENUES PLEDGED THEREFOR UNDER THE ASSESSMENT AREA ONE INDENTURE AND NEITHER THE PROPERTY, THE FULL FAITH AND CREDIT, NOR THE TAXING POWER OF THE ISSUER, OSCEOLA COUNTY, FLORIDA (THE "COUNTY"), THE STATE OF FLORIDA (THE "STATE"), OR ANY OTHER POLITICAL SUBDIVISION THEREOF, IS PLEDGED AS SECURITY FOR THE PAYMENT OF THE ASSESSMENT AREA ONE BONDS, EXCEPT THAT THE ISSUER IS OBLIGATED UNDER THE ASSESSMENT AREA ONE INDENTURE TO LEVY AND TO EVIDENCE AND CERTIFY, OR CAUSE TO BE CERTIFIED, FOR COLLECTION, ASSESSMENT AREA ONE SPECIAL ASSESSMENTS (AS DEFINED IN THE ASSESSMENT AREA ONE INDENTURE) TO SECURE AND PAY THE ASSESSMENT AREA ONE BONDS. THE ASSESSMENT AREA ONE BONDS DO NOT CONSTITUTE AN INDEBTEDNESS OF THE ISSUER, THE COUNTY, THE STATE, OR ANY OTHER POLITICAL SUBDIVISION THEREOF WITHIN THE MEANING OF ANY CONSTITUTIONAL OR STATUTORY PROVISION OR LIMITATION.

This Bond is one of an authorized issue of Assessment Area One Bonds of the Hickory Tree Community Development District, a community development district duly created, organized and existing under Chapter 190, Florida Statutes (the Uniform Community Development District Act of 1980), as amended (the "Act"), Ordinance No. 2022-60 enacted by the Board of County Commissioners of Osceola County, Florida on June 27, 2022, which became effective on June 29, 2022, designated as "Hickory Tree Community Development District Special Assessment Bonds, Series 2023 (Assessment Area One Project)" (the "Assessment Area One Bonds"), in the aggregate principal amount of _____ and 00/100 Dollars (\$ _____) of like date, tenor and effect, except as to number. The Assessment Area One Bonds are being issued under authority of the laws and Constitution of the State, including particularly the Act, to pay, among other things, the costs of constructing and/or acquiring a portion of the Assessment Area One Project (as defined in the herein referred to Assessment Area One Indenture). The Assessment Area One Bonds shall be issued as fully registered Assessment Area One Bonds in Authorized Denominations, as set forth in the Assessment Area One Indenture. The Assessment Area One Bonds are issued under and secured by a Master Trust Indenture dated as of [_____] 1, 2023 (the "Master Indenture"), as supplemented by a First Supplemental Trust Indenture dated as of [_____] 1, 2023 (the "First Supplemental Trust Indenture" and together with the Master Indenture, the "Assessment Area One Indenture"), each by and between the Issuer and the Trustee, executed counterparts of which are on file at the designated corporate trust office of the Trustee in Fort Lauderdale, Florida.

Reference is hereby made to the Assessment Area One Indenture for the provisions, among others, with respect to the custody and application of the proceeds of the Assessment

Area One Bonds issued under the Assessment Area One Indenture, the operation and application of the Assessment Area One Reserve Account within the Debt Service Reserve Fund and other Funds and Accounts (each as defined in the Assessment Area One Indenture) charged with and pledged to the payment of the principal of and the interest on the Assessment Area One Bonds, the levy and the evidencing and certifying for collection, of the Assessment Area One Special Assessments, the nature and extent of the security for the Assessment Area One Bonds, the terms and conditions on which the Assessment Area One Bonds are issued, the rights, duties and obligations of the Issuer and of the Trustee under the Assessment Area One Indenture, the conditions under which such Assessment Area One Indenture may be amended without the consent of the Registered Owners of the Assessment Area One Bonds, the conditions under which such Assessment Area One Indenture may be amended with the consent of the Registered Owners of a majority in aggregate principal amount of the Assessment Area One Bonds outstanding, and as to other rights and remedies of the Registered Owners of the Assessment Area One Bonds.

It is expressly agreed by the Registered Owner of this Bond that such Registered Owner shall never have the right to require or compel the exercise of the ad valorem taxing power of the Issuer, the County, the State or any other political subdivision thereof, or taxation in any form of any real or personal property of the Issuer, the County, the State or any other political subdivision thereof, for the payment of the principal of and interest on this Bond or the making of any other sinking fund and other payments provided for in the Assessment Area One Indenture, except for Assessment Area One Special Assessments to be assessed and levied by the Issuer as set forth in the Assessment Area One Indenture.

By the acceptance of this Bond, the Registered Owner hereof assents to all the provisions of the Assessment Area One Indenture.

This Bond is payable from and secured by Assessment Area One Pledged Revenues, as such term is defined in the Assessment Area One Indenture, all in the manner provided in the Assessment Area One Indenture. The Assessment Area One Indenture provides for the levy and the evidencing and certifying, of non-ad valorem assessments in the form of Assessment Area One Special Assessments to secure and pay the Assessment Area One Bonds.

The Assessment Area One Bonds are subject to redemption prior to maturity in the amounts, at the times and in the manner provided below. All payments of the Redemption Price of the Assessment Area One Bonds shall be made on the dates specified below. Upon any redemption of Assessment Area One Bonds other than in accordance with scheduled mandatory sinking fund redemption amounts, the Issuer shall cause to be recalculated and delivered to the Trustee revised mandatory sinking fund redemption amounts recalculated so as to amortize the Outstanding principal amount of Assessment Area One Bonds in substantially equal annual installments of principal and interest (subject to rounding to Authorized Denominations of principal) over the remaining term of the Assessment Area One Bonds. The mandatory sinking fund redemption amounts as so recalculated shall not result in an increase in the aggregate of the mandatory sinking fund redemption amounts for all Assessment Area One Bonds in any year. In the event of a redemption or purchase occurring less than forty-five (45) days prior to a date on which a mandatory sinking fund redemption amount is due, the foregoing recalculation shall not be made to the mandatory sinking fund redemption amounts due in the year in which such

redemption occurs, but shall be made to the mandatory sinking fund redemption amounts for the immediately succeeding and subsequent years.

Optional Redemption

The Assessment Area One Bonds maturing after May 1, 20__ may, at the option of the Issuer be called for redemption prior to maturity as a whole or in part, at any time, on or after May 1, 20__ (less than all Assessment Area One Bonds of a maturity to be selected by lot), at a Redemption Price equal to the principal amount of Assessment Area One Bonds to be redeemed, plus accrued interest from the most recent Interest Payment Date through which interest has been paid to the redemption date from moneys on deposit in the Assessment Area One Optional Redemption Subaccount of the Assessment Area One Bond Redemption Account. If such optional redemption shall be in part, the Issuer shall select such principal amount of Assessment Area One Bonds to be optionally redeemed from each maturity so that debt service on the remaining Outstanding Assessment Area One Bonds is substantially level.

Extraordinary Mandatory Redemption in Whole or in Part

The Assessment Area One Bonds are subject to extraordinary mandatory redemption prior to maturity by the Issuer in whole or in part, on any date (other than in the case of clause (i) below, which extraordinary mandatory redemption in part must occur on a Quarterly Redemption Date), at a Redemption Price equal to 100% of the principal amount of the Assessment Area One Bonds to be redeemed, plus interest accrued to the redemption date, as follows:

(i) from Assessment Area One Prepayment Principal deposited into the Assessment Area One Prepayment Subaccount of the Assessment Area One Bond Redemption Account following the payment in whole or in part of Assessment Area One Special Assessments on any assessable property within the District in accordance with the provisions of Section 4.05(a) of the First Supplemental Trust Indenture, together with any excess moneys transferred by the Trustee from the Assessment Area One Reserve Account to the Assessment Area One Prepayment Subaccount as a result of such Assessment Area One Prepayment and pursuant to Sections 4.01(f) and 4.05(a) of the First Supplemental Trust Indenture. If such redemption shall be in part, the Issuer shall select such principal amount of Assessment Area One Bonds to be redeemed from each maturity so that debt service on the remaining Outstanding Assessment Area One Bonds is substantially level.

(ii) from moneys, if any, on deposit in the Funds, Accounts and subaccounts held by the Trustee under the First Supplemental Trust Indenture (other than the Assessment Area One Rebate Fund and the Assessment Area One Acquisition and Construction Account) sufficient to pay and redeem all Outstanding Assessment Area One Bonds and accrued interest thereon to the redemption date or dates in addition to all amounts owed to Persons under the Master Indenture.

(iii) upon the Completion Date, from any funds remaining on deposit in the Assessment Area One Acquisition and Construction Account in accordance with the provisions of the First Supplemental Trust Indenture, not otherwise reserved to complete the Assessment

Area One Project and transferred to the Assessment Area One General Redemption Subaccount of the Assessment Area One Bond Redemption Account, together with moneys deposited therein in accordance with the provisions of the First Supplemental Trust Indenture, as a result of the reduction of the Assessment Area One Reserve Requirement. If such redemption shall be in part, the Issuer shall select such principal amount of Assessment Area One Bonds to be redeemed from each maturity so that debt service on the remaining Outstanding Assessment Area One Bonds is substantially level.

Mandatory Sinking Fund Redemption

The Assessment Area One Bonds maturing on May 1, 20__ are subject to mandatory sinking fund redemption from the moneys on deposit in the Assessment Area One Sinking Fund Account on May 1 in the years and in the mandatory sinking fund redemption amounts set forth below at a Redemption Price of 100% of their principal amount plus accrued interest to the date of redemption.

Year	Mandatory Sinking Fund Redemption Amount
	\$

*

* Maturity.

The Assessment Area One Bonds maturing on May 1, 20__ are subject to mandatory sinking fund redemption from the moneys on deposit in the Assessment Area One Sinking Fund Account on May 1 in the years and in the mandatory sinking fund redemption amounts set forth below at a Redemption Price of 100% of their principal amount plus accrued interest to the date of redemption.

Year	Mandatory Sinking Fund Redemption Amount
	\$

*

* Maturity.

The Assessment Area One Bonds maturing on May 1, 20__ are subject to mandatory sinking fund redemption from the moneys on deposit in the Assessment Area One Sinking Fund Account on May 1 in the years and in the mandatory sinking fund redemption amounts set forth below at a Redemption Price of 100% of their principal amount plus accrued interest to the date of redemption.

Year	Mandatory Sinking Fund Redemption Amount	Year	Mandatory Sinking Fund Redemption Amount
	\$		\$

*

* Maturity.

The Assessment Area One Bonds maturing on May 1, 20__ are subject to mandatory sinking fund redemption from the moneys on deposit in the Assessment Area One Sinking Fund Account on May 1 in the years and in the mandatory sinking fund redemption amounts set forth below at a Redemption Price of 100% of their principal amount plus accrued interest to the date of redemption.

Year	Mandatory Sinking Fund Redemption Amount	Year	Mandatory Sinking Fund Redemption Amount
	\$		\$

*

* Maturity.

Except as otherwise provided in the Assessment Area One Indenture, if less than all of the Assessment Area One Bonds subject to redemption shall be called for redemption, the particular such Assessment Area One Bonds or portions of such Assessment Area One Bonds to be redeemed shall be selected by lot by the Registrar as provided in the Assessment Area One Indenture.

Notice of each redemption of the Assessment Area One Bonds is required to be sent by Electronic Means or mailed by the Registrar, postage prepaid, not less than thirty (30) nor more than sixty (60) days prior to the redemption date to each Registered Owner of the Assessment Area One Bonds to be redeemed at the address of such Registered Owner recorded on the bond register maintained by the Registrar. The Issuer may provide that the any optional redemption of Assessment Area One Bonds issued under the Assessment Area One Indenture may be subject to certain conditions; provided that the notice of such conditional optional redemption must

expressly state that such optional redemption is conditional and describe the conditions for such redemption. On the date designated for redemption, notice having been given and money for the payment of the Redemption Price being held by the Paying Agent, all as provided in the Assessment Area One Indenture, the Assessment Area One Bonds or such portions thereof so called for redemption shall become and be due and payable at the Redemption Price provided for the redemption of such Assessment Area One Bonds or such portions thereof on such date, interest on such Assessment Area One Bonds or such portions thereof so called for redemption shall cease to accrue, such Assessment Area One Bonds or such portions thereof so called for redemption shall cease to be entitled to any benefit or security under the Assessment Area One Indenture and the Registered Owners thereof shall have no rights in respect of such Assessment Area One Bonds or such portions thereof so called for redemption except to receive payments of the Redemption Price thereof so held by the Paying Agent. Further notice of redemption shall be given by the Registrar to certain registered securities depositories and information services as set forth in the Assessment Area One Indenture, but no defect in said further notice nor any failure to give all or any portion of such further notice shall in any manner defeat the effectiveness of a call for redemption if notice thereof is given as above prescribed.

The Registered Owner of this Bond shall have no right to enforce the provisions of the Assessment Area One Indenture or to institute action to enforce the covenants therein, or to take any action with respect to any Event of Default under the Assessment Area One Indenture, or to institute, appear in or defend any suit or other proceeding with respect thereto, except as provided in the Assessment Area One Indenture.

In certain events, on the conditions, in the manner and with the effect set forth in the Assessment Area One Indenture, the principal of all the Assessment Area One Bonds then Outstanding under the Assessment Area One Indenture may become and may be declared due and payable before the stated maturity thereof, with the interest accrued thereon.

Modifications or alterations of the Assessment Area One Indenture or of any Assessment Area One Indenture supplemental thereto may be made only to the extent and in the circumstances permitted by the Assessment Area One Indenture.

Any moneys held by the Trustee or Paying Agent in trust for the payment and discharge of any Bond which remain unclaimed for two (2) years after the date when such Bond has become due and payable, either at its stated maturity date or by call for earlier redemption shall be paid to the Issuer, thereupon and thereafter no claimant shall have any rights against the Trustee or Paying Agent to or in respect of such moneys.

If the Issuer deposits or causes to be deposited with the Trustee funds or Government Obligations (as defined in the Master Indenture) sufficient to pay the principal or Redemption Price of any Assessment Area One Bond becoming due at maturity or by call for redemption in the manner set forth in the Assessment Area One Indenture, together with the interest accrued to the due date or date of redemption, as applicable, the lien of such Assessment Area One Bonds as to the Trust Estate with respect to the Assessment Area One Bonds shall be discharged, except for the rights of the Registered Owners thereof with respect to the funds so deposited as provided in the Assessment Area One Indenture.

This Bond shall have all the qualities and incidents, including negotiability, of investment securities within the meaning and for all the purposes of the Uniform Commercial Code of the State of Florida.

This Bond shall initially be issued in the name of Cede & Co. as nominee for DTC, and so long as this Bond is held in book-entry-only form Cede & Co. shall be considered the Registered Owner for all purposes hereof, including the payment of the principal of and interest on this Bond. Payment to DTC Participants shall be the responsibility of DTC. Payments by DTC Participants to Indirect Participants, and by DTC Participants and Indirect Participants to individual Beneficial Owners shall be the responsibility of DTC Participants and Indirect Participants and not of DTC, the Issuer or the Trustee.

The Issuer shall keep books for the registration of the Assessment Area One Bonds at the designated corporate trust office of the Registrar in Fort Lauderdale, Florida. Subject to the restrictions contained in the Assessment Area One Indenture, and except when the Assessment Area One Bonds are registered in book-entry only form, the Assessment Area One Bonds may be transferred or exchanged by the Registered Owner thereof in person or by his attorney duly authorized in writing only upon the books of the Issuer kept by the Registrar and only upon surrender thereof together with a written instrument of transfer satisfactory to the Registrar duly executed by the Registered Owner or his duly authorized attorney. In all cases in which the privilege of transferring or exchanging Assessment Area One Bonds is exercised, the Issuer shall execute and the Trustee shall authenticate and deliver a new Bond or Assessment Area One Bonds in authorized form and in like aggregate principal amount in accordance with the provisions of the Assessment Area One Indenture. Every Bond presented or surrendered for transfer or exchange shall be duly endorsed or accompanied by a written instrument of transfer in form satisfactory to the Trustee, Paying Agent or the Registrar, duly executed by the Bondholder or his attorney duly authorized in writing. Transfers and exchanges shall be made without charge to the Bondholder, except that the Issuer or the Trustee may require payment of a sum sufficient to cover any tax or other governmental charge that may be imposed in connection with any transfer or exchange of Assessment Area One Bonds. Neither the Issuer nor the Registrar on behalf of the Issuer shall be required (i) to issue, transfer or exchange any Assessment Area One Bond during a period beginning at the opening of business fifteen (15) days before the day of mailing of a notice of redemption of Assessment Area One Bonds selected for redemption and ending at the close of business on the day of such mailing, or (ii) to transfer or exchange any Assessment Area One Bond so selected for redemption in whole or in part.

The Issuer, the Trustee, the Paying Agent and the Registrar shall deem and treat the person in whose name any Bond shall be registered upon the books kept by the Registrar as the absolute owner thereof (whether or not such Bond shall be overdue, and notwithstanding any notation of ownership or other writing thereon made by anyone other than the Issuer, the Trustee, any Paying Agent, the Registrar or the Authenticating Agent) for the purpose of receiving payment of or on account of the principal of, premium, if any, and interest on such Bond as the same becomes due, and for all other purposes. All such payments so made to any such Registered Owner or upon his order shall be valid and effectual to satisfy and discharge the liability upon such Bond to the extent of the sum or sums so paid, and neither the Issuer, the Trustee, the Paying Agent, nor the Registrar shall be affected by any notice to the contrary.

It is hereby certified and recited that all acts, conditions and things required to exist, to happen, and to be performed, precedent to and in the issuance of this Bond exist, have happened and have been performed in regular and due form and time as required by the laws and Constitution of the State of Florida applicable thereto, including particularly the Act, and that the issuance of this Bond, and of the issue of the Assessment Area One Bonds of which this Bond is one, is in full compliance with all constitutional and statutory limitations or provisions.

This Bond shall not be valid or become obligatory for any purpose or be entitled to any benefit or security under the Assessment Area One Indenture until it shall have been authenticated by execution of the Trustee, or such other authenticating agent as may be appointed by the Trustee under the Assessment Area One Indenture, of the certificate of authentication endorsed hereon.

[REMAINDER OF PAGE INTENTIONALLY LEFT BLANK – SIGNATURE PAGE
FOLLOWS]

IN WITNESS WHEREOF, Hickory Tre Community Development District has caused this Bond to be signed by the facsimile signature of the Chairperson of its Board of Supervisors and a facsimile of its seal to be imprinted hereon, and attested by the facsimile signature of the Secretary of its Board of Supervisors, all as of the date hereof.

**HICKORY TREE COMMUNITY
DEVELOPMENT DISTRICT**

By: _____
Chairperson, Board of Supervisors

(SEAL)

Attest:

By: _____
Secretary, Board of Supervisors

CERTIFICATE OF AUTHENTICATION

This Bond is one of the Assessment Area One Bonds delivered pursuant to the within mentioned Assessment Area One Indenture.

Date of Authentication: _____

**U.S. BANK TRUST COMPANY,
NATIONAL ASSOCIATION,
as Trustee**

By: _____
Authorized Signatory

STATEMENT OF VALIDATION

This Bond is one of a series of Bonds which were validated by judgment of the Circuit Court of the Ninth Judicial Circuit of Florida, in and for Osceola County, rendered on the 20th day of December, 2022.

**HICKORY TREE COMMUNITY
DEVELOPMENT DISTRICT**

By: _____
Chairperson, Board of Supervisors

(SEAL)

Attest:

By: _____
Secretary, Board of Supervisors

ABBREVIATIONS

The following abbreviations, when used in the inscription on the face of the within Bond, shall be construed as though they were written out in full according to applicable laws or regulations:

TEN COM - as tenants in common
TEN ENT - as tenants by the entireties
JT TEN - as joint tenants with rights of survivorship and
not as tenants in common

UNIFORM TRANSFER MIN ACT - _____ Custodian _____
(Cust) (Minor)
Under Uniform Transfer to Minors Act _____
(State)

Additional abbreviations may also be used though not in the above list.

ASSIGNMENT AND TRANSFER

FOR VALUE RECEIVED the undersigned sells, assigns and transfers unto

(please print or typewrite name and address of assignee)

the within Bond and all rights thereunder, and hereby irrevocably constitutes and appoints

Attorney to transfer the within Bond on the books kept for registration thereof, with full power of substitution in the premises.

Signature Guarantee:

NOTICE: Signature(s) must be guaranteed by a member firm of the New York Stock Exchange or a commercial bank or trust company

NOTICE: The signature to this assignment must correspond with the name of the Registered Owner as it appears upon the face of the within Bond in every particular, without alteration or enlargement or any change whatsoever.

Please insert social security or other identifying number of Assignee.

EXHIBIT C

FORMS OF REQUISITIONS

**HICKORY TREE COMMUNITY DEVELOPMENT DISTRICT
SPECIAL ASSESSMENT BONDS, SERIES 2023
(ASSESSMENT AREA ONE PROJECT)
(Acquisition and Construction)**

The undersigned, a Responsible Officer of the Hickory Tree Community Development District (the "District") hereby submits the following requisition for disbursement under and pursuant to the terms of the Master Trust Indenture by and between the District and U.S. Bank Trust Company, National Association, as trustee (the "Trustee"), dated as of [_____] 1, 2023 as supplemented by that certain First Supplemental Trust Indenture dated as of [_____] 1, 2023 (collectively, the "Assessment Area One Indenture") (all capitalized terms used herein shall have the meaning ascribed to such term in the Assessment Area One Indenture):

- (A) Requisition Number:
- (B) Identify Acquisition Agreement, if applicable;
- (C) Name of Payee pursuant to Acquisition Agreement:
- (D) Amount Payable:
- (E) Purpose for which paid or incurred (refer also to specific contract if amount is due and payable pursuant to a contract involving progress payments):
- (F) Fund or Account and subaccount, if any, from which disbursement to be made:

Assessment Area One Acquisition and Construction Account of the Acquisition and Construction Fund

The undersigned hereby certifies that:

- 1. obligations in the stated amount set forth above have been incurred by the District,
- 2. each disbursement set forth above is a proper charge against the:
Assessment Area One Acquisition and Construction Account of the Acquisition and Construction Fund; and
- 3. each disbursement set forth above was incurred in connection with:
the Costs of the Assessment Area One Project.

The undersigned hereby further certifies that there has not been filed with or served upon the District notice of any lien, right to lien, or attachment upon, or claim affecting the right to

receive payment of, any of the moneys payable to the Payee set forth above, which has not been released or will not be released simultaneously with the payment hereof.

The undersigned hereby further certifies that such requisition contains no item representing payment on account of any retained percentage which the District is at the date of such certificate entitled to retain.

Attached hereto or on file with the District are copies of the invoice(s) or applicable contracts from the vendor of the property acquired or the services rendered, as well as applicable conveyance instruments (e.g. deed(s), bill(s) of sale, easement(s), etc.) with respect to which disbursement is hereby requested.

**HICKORY TREE COMMUNITY
DEVELOPMENT DISTRICT**

By: _____
Responsible Officer

Date: _____

**CONSULTING ENGINEER'S APPROVAL FOR
NON-COST OF ISSUANCE OR [NON-OPERATING COSTS REQUESTS ONLY]**

The undersigned Consulting Engineer hereby certifies that this disbursement is for a Cost of the Assessment Area One Project and is consistent with: (i) the applicable acquisition or construction contract; (ii) the plans and specifications for the portion of the Assessment Area One Project with respect to which such disbursement is being made; and (iii) the report of the Consulting Engineer, as such report shall have been amended or modified on the date hereof. The Consulting Engineer further certifies and agrees that for any acquisition (a) the portion of the Assessment Area One Project that is the subject of this requisition is complete, and (b) the purchase price to be paid by the District for the portion of the Assessment Area One Project to be acquired with this disbursement is no more than the lesser of (i) the fair market value of such improvements and (ii) the actual cost of construction of such improvements.

Consulting Engineer

Date: _____

FORMS OF REQUISITIONS

HICKORY TREE COMMUNITY DEVELOPMENT DISTRICT SPECIAL ASSESSMENT BONDS, SERIES 2023 (ASSESSMENT AREA ONE PROJECT) (Costs of Issuance)

The undersigned, a Responsible Officer of the Hickory Tree Community Development District (the "District") hereby submits the following requisition for disbursement under and pursuant to the terms of the Master Trust Indenture by and between the District and U.S. Bank Trust Company, National Association, as trustee (the "Trustee"), dated as of [_____] 1, 2023, as supplemented by that certain First Supplemental Trust Indenture dated as of [_____] 1, 2023 (collectively, the "Assessment Area One Indenture") (all capitalized terms used herein shall have the meaning ascribed to such term in the Assessment Area One Indenture):

- (A) Requisition Number:
- (B) Amount Payable:
- (C) Purpose for which paid or incurred: Costs of Issuance
- (D) Fund or Account and subaccount, if any, from which disbursement to be made:

Assessment Area One Costs of Issuance Account of the Acquisition and Construction Fund

The undersigned hereby certifies that:

1. this requisition is for Costs of Issuance payable from the Assessment Area One Costs of Issuance Account that have not previously been paid;
2. each disbursement set forth above is a proper charge against the Assessment Area One Costs of Issuance Account;
3. each disbursement set forth above was incurred in connection with the issuance of the Assessment Area One Bonds; and
4. each disbursement represents a cost of issuance which has not previously been paid.

The undersigned hereby further certifies that there has not been filed with or served upon the District notice of any lien, right to lien, or attachment upon, or claim affecting the right to receive payment of, any of the moneys payable to the Payee set forth above, which has not been released or will not be released simultaneously with the payment hereof.

The undersigned hereby further certifies that such requisition contains no item representing payment on account of any retained percentage which the District is at the date of such certificate entitled to retain.

Attached hereto or on file with the District are copies of the invoice(s) from the vendor of the services rendered, with respect to which disbursement is hereby requested.

**HICKORY TREE COMMUNITY
DEVELOPMENT DISTRICT**

By: _____
Responsible Officer

Date: _____

EXHIBIT D
FORM OF INVESTOR LETTER

[Date]

FMSbonds, Inc.
20660 W. Dixie Highway
North Miami Beach, FL 33180

Re: \$ _____ Hickory Tree Community Development District Special
Assessment Bonds, Series 2023 (Assessment Area One Project)

Ladies and Gentlemen:

The undersigned is authorized to sign this letter [on behalf of Name of Non-Individual Investor], as the beneficial owner (the "Investor") of \$ _____ of the above-referenced Bonds [maturing on _____, _____, bearing interest at the rate of ___% per annum and CUSIP #] (herein, the "Investor Bonds").

In connection with the purchase of the Investor Bonds by the Investor, the Investor hereby makes the following representations upon which you may rely:

1. The Investor has authority to purchase the Investor Bonds and to execute this letter, any other instruments and documents required to be executed by the Investor in connection with the purchase of the Investor Bonds.

2. The Investor meets the criteria of an "accredited investor" as described in one or more of the categories derived from Rule 501(a) under Regulation D of the Securities Act of 1933, as amended (the "Securities Act") summarized below, and therefore, has sufficient knowledge and experience in financial and business matters, including purchase and ownership of municipal and other tax-exempt obligations including those which are not rated or credit-enhanced, to be able to evaluate the risks and merits of the investment represented by the Bonds. Please check the appropriate box below to indicate the type of accredited investor:

a bank, registered broker, dealer or investment adviser (or investment adviser exempt from registration under Section 203(l) or (m) within the meaning of the Investment Advisers Act of 1940), insurance company, registered investment company, business development company, small business investment company; or rural business investment company;

an employee benefit plan, within the meaning of the Employee Retirement Income Security Act of 1974, if a bank, insurance company, or registered investment adviser makes the investment decisions, or if the employee benefit plan has total assets in excess of \$5 million;

an organization described in Section 501(c)(3) of the Internal Revenue Code of 1986, as amended, corporation, Massachusetts or similar business trust partnership, or limited liability company, not formed for the specific purpose of acquiring the Investor Bonds with assets exceeding \$5 million;

- a business in which all the equity owners are "accredited investors";
- a natural person who has individual net worth, or joint net worth with the person's spouse or spousal equivalent, that exceeds \$1 million at the time of the purchase, excluding the value of the primary residence of such person, except that mortgage indebtedness on the primary residence shall not be included as a liability;
- a natural person with income exceeding \$200,000 in each of the two most recent years or joint income with a spouse or spousal equivalent exceeding \$300,000 for those years and a reasonable expectation of the same income level in the current year;
- a trust with total assets in excess of \$5,000,000, not formed for the specific purpose of acquiring the Investor Bonds whose purchase is directed by a sophisticated person;
- an entity, of a type other than those set forth above, that owns investments in excess of \$5,000,000 and that was not formed for the specific purpose of acquiring the Investor Bonds;
- a natural person holding in good standing one or more professional certifications or designations or credentials from a designated accredited educational institution qualifying an individual for "accredited investor" status;
- a "family office" with at least \$5,000,000 in assets under management, that was not formed for the specific purpose of acquiring the Investor Bonds, and whose prospective investment is directed by a person capable of evaluating the merits and risks of the prospective investment; or
- a "family client" of a family office described in the prior bullet point whose prospective investment is directed by that family office.

3. The Investor has been supplied with an (electronic) copy of the Preliminary Limited Offering Memorandum dated [_____, 2023] of the Issuer and relating to the Bonds (the "Offering Document") and has reviewed the Offering Document and represents that such Offering Document has provided full and meaningful disclosure in order to make an informed decision to invest in the Investor Bonds.

Capitalized terms used herein and not otherwise defined have the meanings given to such terms in the Assessment Area One Indenture.

Very truly yours,

[Name], [Type of Entity]

By: _____

Name: _____

Title: _____

Date: _____

Or

[Name], an Individual

EXHIBIT B

FORM OF BOND PURCHASE CONTRACT

**HICKORY TREE COMMUNITY DEVELOPMENT DISTRICT
(OSCEOLA COUNTY, FLORIDA)**

\$[_____]]
**SPECIAL ASSESSMENT BONDS, SERIES 2023
(ASSESSMENT AREA ONE PROJECT)**

BOND PURCHASE CONTRACT

[_____] , 2023

Board of Supervisors
Hickory Tree Community Development District
Osceola County, Florida

Dear Board of Supervisors:

FMSbonds, Inc. (the "Underwriter") offers to enter into this Bond Purchase Contract (the "Purchase Contract") with Hickory Tree Community Development District (the "District"). The District is located entirely within unincorporated Osceola County, Florida (the "County"). This offer of the Underwriter shall, unless accepted by the District, acting through its Board of Supervisors (the "Board"), expire at [4:00 P.M.] prevailing time within the jurisdiction of the District on the date hereof, unless previously withdrawn or extended in writing by the Underwriter. This Purchase Contract shall be binding upon the District and the Underwriter upon execution and delivery. Any capitalized word not defined herein shall have the meaning ascribed thereto in the Preliminary Limited Offering Memorandum (as hereinafter defined). In conformance with Section 218.385, Florida Statutes, as amended, the Underwriter hereby delivers to the District the Disclosure and Truth-In-Bonding Statements attached hereto as Exhibit A.

1. Purchase and Sale. Upon the terms and conditions and upon the basis of the representations, warranties and agreements set forth herein, the Underwriter hereby agrees to purchase from the District and the District hereby agrees to sell and deliver to the Underwriter, all (but not less than all) of its \$[_____] aggregate principal amount of Hickory Tree Community Development District Special Assessment Bonds, Series 2023 (Assessment Area One Project) (the "Assessment Area One Bonds"). The Assessment Area One Bonds shall be dated their date of delivery and shall mature on the dates, shall bear interest at the rates, and shall be subject to redemption prior to maturity, all as provided in Exhibit B attached hereto. The purchase price for the Assessment Area One Bonds shall be \$[_____] (representing the \$[_____] aggregate principal amount of the Assessment Area One Bonds, [plus/less net original issue premium/discount of \$[_____] and] less an underwriter's discount of \$[_____]). The payment for and delivery of the Assessment Area One Bonds and the other actions contemplated hereby to take place at the Closing Date (as hereinafter defined) being hereinafter referred to as the "Closing."

2. The Assessment Area One Bonds. The Assessment Area One Bonds are to be issued by the District, a local unit of special-purpose government of the State of Florida (the "State"), created pursuant to the Uniform Community Development District Act of 1980, Chapter 190, Florida Statutes, as amended, any successor statute thereto, the Florida Constitution, and other applicable provisions of law (collectively, the "Act"), and by Ordinance No. 2022-60 duly enacted by the Board of County Commissioners of Osceola County on June 27, 2022, which became effective on June 29, 2022 (the "Ordinance"). The Assessment Area One Bonds are being issued pursuant to the Act and secured pursuant to the provisions of a Master Trust Indenture dated as of [_____] 1, 2023 (the "Master Indenture"), as amended and supplemented by a First Supplemental Trust Indenture dated as of [_____] 1, 2023 (the "First Supplemental Indenture" and, together with the Master Indenture, the "Indenture"), each by and between the District and U.S. Bank

Trust Company, National Association, as trustee (the "Trustee"), and Resolution Nos. 2022-26 and 2023- [] adopted by the Board on July 14, 2022 and [September 6], 2023, respectively (collectively, and together with the Supplemental Bond Resolution as described herein, the "Bond Resolution"). The Assessment Area One Special Assessments, constituting the Assessment Area One Pledged Revenues for the Assessment Area One Bonds, will have been, or will be prior to the time of Closing, levied by the District on the lands within the District specially benefited by the Assessment Area One Project pursuant to the Assessment Resolutions (as such terms are defined in the Indenture).

3. Limited Offering; Establishment of Issue Price. It shall be a condition to the District's obligation to sell and to deliver the Assessment Area One Bonds to the Underwriter, and to the Underwriter's obligation to purchase, accept delivery of and pay for the Assessment Area One Bonds, that the entire principal amount of the Assessment Area One Bonds be issued, sold and delivered by the District and purchased, accepted and paid for by the Underwriter at the Closing and that the District and the Underwriter receive the opinions, documents and certificates described in Section 8(c) hereof.

(a) The Underwriter agrees to assist the District in establishing the issue price of the Assessment Area One Bonds and shall execute and deliver to the District at Closing an "issue price" or similar certificate, together with the supporting pricing wires or equivalent communications, in a form reasonably satisfactory to Bond Counsel, with such modifications as may be appropriate or necessary, in the reasonable judgment of the Underwriter, the District and Bond Counsel, to accurately reflect, as applicable, the sales price or prices or the initial offering price or prices to the public of the Assessment Area One Bonds.

(b) Except as otherwise indicated in Exhibit B, the District will treat the first price at which 10% of each maturity of the Assessment Area One Bonds (the "10% test") is sold to the public as the issue price of that maturity. At or promptly after the execution of this Purchase Contract, the Underwriter shall report to the District the price or prices at which the Underwriter has sold to the public each maturity of Assessment Area One Bonds. If at that time the 10% test has not been satisfied as to any maturity, the Underwriter agrees to promptly report to the District the prices at which the Assessment Area One Bonds of that maturity have been sold by the Underwriter to the public. That reporting obligation shall continue, whether or not the Closing Date has occurred, until the 10% test has been satisfied as to the Assessment Area One Bonds of that maturity or until all Assessment Area One Bonds of that maturity have been sold to the public provided that, the Underwriter's reporting obligation after the Closing Date may be at reasonable periodic intervals or otherwise upon request of the Issuer or bond counsel. For purposes of this Section, if Assessment Area One Bonds mature on the same date but have different interest rates, each separate CUSIP number within that maturity will be treated as a separate maturity of the Assessment Area One Bonds.

(c) The Underwriter confirms that it has offered the Assessment Area One Bonds to accredited investors constituting the public on or before the date of this Purchase Contract at the offering price or prices (the "initial offering price"), or at the corresponding yield or yields, set forth in Exhibit B attached hereto, except as otherwise set forth therein. Exhibit B also sets forth, as of the date of this Purchase Contract, the maturities of the Assessment Area One Bonds, if any, for which the 10% test has not been satisfied and for which the District and the Underwriter agree that the restrictions set forth in the next sentence shall apply, which will allow the District to treat the initial offering price to the public of each such maturity as of the sale date as the issue price of that maturity (the "hold-the-offering-price rule"). So long as the hold-the-offering-price rule remains applicable to any maturity of the Assessment Area One Bonds, the Underwriter will neither offer nor sell unsold Assessment Area One Bonds of that maturity to any person at a price that is higher

than the initial offering price to the public during the period starting on the sale date and ending on the earlier of the following:

- (1) the close of the fifth (5th) business day after the sale date; or
- (2) the date on which the Underwriter has sold at least 10% of that maturity of the Assessment Area One Bonds to the public at a price that is no higher than the initial offering price to the public.

The Underwriter will advise the District promptly after the close of the fifth (5th) business day after the sale date whether it has sold 10% of that maturity of the Assessment Area One Bonds to the public at a price that is no higher than the initial offering price to the public.

(d) The Underwriter confirms that:

(i) any selling group agreement and any third-party distribution agreement relating to the initial sale of the Assessment Area One Bonds to the public, together with the related pricing wires, contains or will contain language obligating each dealer who is a member of the selling group and each broker-dealer that is a party to such third-party distribution agreement, as applicable:

(A) (i) to report the prices at which it sells to the public the unsold Assessment Area One Bonds of each maturity allocated to it, whether or not the Closing Date has occurred, until either all Assessment Area One Bonds of that maturity allocated to it have been sold or it is notified by the Underwriter that the 10% test has been satisfied as to the Assessment Area One Bonds of that maturity, provided that, the reporting obligation after the Closing Date may be at reasonable periodic intervals or otherwise upon request of the Underwriter, and (ii) to comply with the hold-the-offering-price rule, if applicable, if and for so long as directed by the Underwriter,

(B) to promptly notify the Underwriter of any sales of Assessment Area One Bonds that, to its knowledge, are made to a purchaser who is a related party to an underwriter participating in the initial sale of the Assessment Area One Bonds to the public (each such term being used as defined below), and

(C) to acknowledge that, unless otherwise advised by the dealer or broker-dealer, the Underwriter shall assume that each order submitted by the dealer or broker-dealer is a sale to the public.

(ii) any selling group agreement relating to the initial sale of the Assessment Area One Bonds to the public, together with the related pricing wires, contains or will contain language obligating each dealer that is a party to a third-party distribution agreement to be employed in connection with the initial sale of the Assessment Area One Bonds to the public to require each broker-dealer that is a party to such third-party distribution agreement to (A) report the prices at which it sells to the public the unsold Assessment Area One Bonds of each maturity allocated to it, whether or not the Closing Date has occurred, until either all Assessment Area One Bonds of that maturity allocated to it have been sold or it is notified by the Underwriter or the dealer that the 10% test has been satisfied as to the Assessment Area One Bonds of that maturity, provided that, the reporting obligation after the Closing Date may be at reasonable periodic intervals or otherwise upon request of the Underwriter or the dealer, and (B) comply with the hold-the-

offering-price rule, if applicable, if and for so long as directed by the Underwriter or the dealer and as set forth in the related pricing wires.

(e) The District acknowledges that, in making the representation set forth in this subsection, the Underwriter will rely on (i) in the event a selling group has been created in connection with the initial sale of the Assessment Area One Bonds to the public, the agreement of each dealer who is a member of the selling group to comply with the requirements for establishing issue price of the Assessment Area One Bonds, including, but not limited to, its agreement to comply with the hold-the-offering-price rule, if applicable to the Assessment Area One Bonds, as set forth in a selling group agreement and the related pricing wires, and (ii) in the event that a third-party distribution agreement was employed in connection with the initial sale of the Assessment Area One Bonds to the public, the agreement of each broker-dealer that is a party to such agreement to comply with the requirements for establishing issue price of the Assessment Area One Bonds, including, but not limited to, its agreement to comply with the hold-the-offering-price rule, if applicable to the Assessment Area One Bonds, as set forth in the third-party distribution agreement and the related pricing wires. The District further acknowledges that the Underwriter shall not be liable for the failure of any dealer who is a member of a selling group, or of any broker-dealer that is a party to a third-party distribution agreement, to comply with its corresponding agreement to comply with the requirements for establishing issue price of the Assessment Area One Bonds, including, but not limited to, its agreement to comply with the hold-the-offering-price rule, if applicable to the Assessment Area One Bonds.

(f) The Underwriter acknowledges that sales of any Assessment Area One Bond to any person that is a related party to an Underwriter participating in the initial sale of the Assessment Area One Bonds to the public (each such term being used as defined below) shall not constitute sales to the public for purposes of this section. Further, for purposes of this section:

(i) "public" means any person other than an underwriter or a related party,

(ii) "underwriter" means (A) any person that agrees pursuant to a written contract with the District (or with the Underwriter to form an underwriting syndicate) to participate in the initial sale of the Assessment Area One Bonds to the public and (B) any person that agrees pursuant to a written contract directly or indirectly with a person described in clause (A) to participate in the initial sale of the Assessment Area One Bonds to the public (including a member of a selling group or a party to a third-party distribution agreement participating in the initial sale of the Assessment Area One Bonds to the public),

(iii) a purchaser of any of the Assessment Area One Bonds is a "related party" to an underwriter if the underwriter and the purchaser are subject, directly or indirectly, to (A) more than 50% common ownership of the voting power or the total value of their stock, if both entities are corporations (including direct ownership by one corporation of another), (B) more than 50% common ownership of their capital interests or profits interests, if both entities are partnerships (including direct ownership by one partnership of another), or (C) more than 50% common ownership of the value of the outstanding stock of the corporation or the capital interests or profit interests of the partnership, as applicable, if one entity is a corporation and the other entity is a partnership (including direct ownership of the applicable stock or interests by one entity of the other), and

(iv) "sale date" means the date of execution of this Purchase Contract by all parties.

4. Use of Documents. Prior to the date hereof, the District has caused to be prepared and has provided to the Underwriter a Preliminary Limited Offering Memorandum, dated [____], 2023 (the "Preliminary Limited Offering Memorandum"), of the District, relating to the Assessment Area One Bonds that the District has deemed final as of its date, except for certain permitted omissions (the "Permitted Omissions"), as contemplated by Rule 15c2-12 of the Securities and Exchange Commission (the "Rule") in connection with the limited offering of the Assessment Area One Bonds. The Underwriter has reviewed the Preliminary Limited Offering Memorandum prior to the execution of this Purchase Contract. The District has, prior to the date hereof, authorized the use of the Preliminary Limited Offering Memorandum by the Underwriter in connection with the limited offering of the Assessment Area One Bonds. The District shall deliver, or cause to be delivered, at its expense, to the Underwriter within seven (7) business days after the date hereof but not later than the Closing Date (as hereinafter defined) and in sufficient time to accompany any confirmation that requests payment from any customer such number of copies of the final Limited Offering Memorandum (the "Limited Offering Memorandum" and, together with the Preliminary Limited Offering Memorandum, the "Limited Offering Memoranda") as the Underwriter shall reasonably request to comply with the requirements of the Rule and all applicable rules of the Municipal Securities Rulemaking Board (the "MSRB"). The Underwriter agrees to file the Limited Offering Memorandum with the MSRB not later than two (2) business days after the Closing Date. The Underwriter agrees that it will not confirm the sale of any Assessment Area One Bonds unless a final written confirmation of sale is accompanied or preceded by the delivery of a copy of the Limited Offering Memorandum. The District hereby approves the circulation and use by the Underwriter of the Limited Offering Memoranda with respect to the Assessment Area One Bonds.

5. Definitions. For purposes hereof, (a) this Purchase Contract, the Assessment Area One Bonds, the Indenture, the Continuing Disclosure Agreement to be dated as of the Closing Date, by and among the District, Clayton Properties Group, Inc., a Tennessee corporation (the "Developer"), and Governmental Management Services - Central Florida, LLC, a Florida limited liability company, as dissemination agent (the "Dissemination Agent"), in substantially the form attached to the Preliminary Limited Offering Memorandum as APPENDIX E thereto (the "Disclosure Agreement") and the DTC Blanket Issuer Letter of Representations entered into by the District are referred to herein collectively as the "Financing Documents," and (b) [the Agreement Regarding the Completion of Certain Improvements by and between the District and the Developer dated as of the Closing Date (the "Completion Agreement"), the Agreement Regarding the Acquisition of Work Product, Improvements and Real Property by and between the District and the Developer dated as of the Closing Date (the "Acquisition Agreement"), the Collateral Assignment and Assumption of Development Rights by and between the District and the Developer, dated as of the Closing Date in recordable form (the "Collateral Assignment"), and the Agreement Regarding True-Up by and between the District and the Developer dated as of the Closing Date in recordable form (the "True-Up Agreement")] are collectively referred to herein as the "Ancillary Agreements."

6. Representations, Warranties and Agreements. The District hereby represents, warrants and agrees as follows:

(a) The Board is the governing body of the District and the District is and will be on the Closing Date duly organized and validly existing as a unit of special-purpose government created pursuant to the Constitution and laws of the State, including, without limitation, the Act;

(b) The District has full legal right, power and authority to: (i) adopt the Bond Resolution and the Assessment Resolutions; (ii) enter into the Financing Documents and Ancillary Agreements; (iii) sell, issue and deliver the Assessment Area One Bonds to the Underwriter as provided herein; (iv) apply the proceeds of the sale of the Assessment Area One Bonds for the purposes described in the Limited Offering Memoranda; (v) authorize and acknowledge the use of

the Limited Offering Memoranda and authorize the execution of the Limited Offering Memorandum; and (vi) carry out and consummate the transactions contemplated by the Bond Resolution, the Assessment Resolutions, the Financing Documents, the Ancillary Agreements, and the Limited Offering Memoranda. The District has complied, and on the Closing Date will be in compliance in all material respects, with the terms of the Act and with the obligations on its part contained in the Bond Resolution, the Assessment Resolutions, the Financing Documents, the Ancillary Agreements and the Assessment Area One Bonds;

(c) At meetings of the Board that were duly called and noticed and at which a quorum was present and acting throughout, the Board duly adopted the Bond Resolution and the Assessment Resolutions, and the same are in full force and effect and have not been supplemented, amended, modified or repealed, except as set forth therein and, with respect to the Bond resolution, as will be supplemented by the Supplemental Bond Resolution. By all necessary official Board action, the District has duly authorized and approved the use and delivery of the Preliminary Limited Offering Memorandum and the execution and delivery of the Financing Documents, the Ancillary Agreements, the Assessment Area One Bonds and the Limited Offering Memorandum, has duly authorized and approved the performance by the District of the obligations on its part contained in the Financing Documents, the Ancillary Agreements and the Assessment Area One Bonds and the consummation by it of all other transactions contemplated by this Purchase Contract and the Limited Offering Memoranda in connection with the issuance of the Assessment Area One Bonds. Upon execution and delivery by the District and the Trustee (and assuming the due authorization, execution and delivery of the Indenture by the Trustee), the Indenture will constitute a legal, valid and binding obligation of the District, enforceable in accordance with its terms, subject only to applicable bankruptcy, insolvency, and similar laws affecting creditors' rights and subject, as to enforceability, to general principles of equity (regardless of whether enforcement is sought in a proceeding in equity or at law). Upon execution by the District and the other parties thereto (and assuming the due authorization, execution and delivery of such agreements by the other parties thereto) the Financing Documents and the Ancillary Agreements will constitute the legal, valid and binding obligations of the District, enforceable in accordance with their respective terms; subject only to applicable bankruptcy, insolvency and similar laws affecting creditors' rights and subject, as to enforceability, to general principles of equity (regardless of whether enforcement is sought in a proceeding in equity or at law);

(d) Except as may be expressly disclosed in the Preliminary Limited Offering Memorandum, the District is not in material breach of or material default under any applicable provision of the Act or any applicable constitutional provision or statute or, to the best of its knowledge, administrative regulation of the State or the United States of America or any applicable judgment or decree, or any loan agreement, indenture, bond, note, resolution, agreement, or other material instrument to which the District is a party or to which the District or any of its property or assets is otherwise subject, and to the best of its knowledge, no event has occurred and is continuing which with the passage of time or the giving of notice, or both, would constitute a material default or material event of default under any such instrument; and the execution and delivery of the Assessment Area One Bonds, the Financing Documents, the Ancillary Agreements and the Limited Offering Memorandum, the approval of the delivery of the Preliminary Limited Offering Memorandum, and the adoption of the Bond Resolution and the Assessment Resolutions, and compliance with the provisions on the District's part contained therein, will not conflict with or constitute a material breach of or material default under any applicable constitutional provision, or law, or, to the best of its knowledge, any administrative regulation, judgment, decree, loan agreement, indenture, bond, note, resolution, agreement, or other instrument to which the District is a party or to which the District or any of its property or assets is otherwise subject, nor will any such execution, delivery, adoption, or compliance result in the creation or imposition of any lien,

charge, or other security interest or encumbrance of any nature whatsoever upon any of the property or assets of the District or under the terms of any such law, regulation or instrument, except as provided by the Assessment Resolutions, the Assessment Area One Bonds and the Indenture. To the best of its knowledge, no event has occurred which, with the lapse of time or the giving of notice, or both, would constitute an event of default (as therein defined) under the Assessment Area One Bonds, the Financing Documents or the Ancillary Agreements;

(e) All authorizations, approvals, licenses, permits, consents and orders of any governmental authority, legislative body, board, agency or commission having jurisdiction of the matters which are required for the due authorization by, or which would constitute a condition precedent to, or the absence of which would materially adversely affect, the due performance by the District of its obligations, to issue the Assessment Area One Bonds, or under the Assessment Area One Bonds, the Bond Resolution, the Assessment Resolutions, Financing Documents or the Ancillary Agreements have been duly obtained, except for such approvals, consents and orders as may be required under the Blue Sky or securities laws of any state in connection with the offering and sale of the Assessment Area One Bonds;

(f) The descriptions of the Assessment Area One Bonds, the Financing Documents, the Ancillary Agreements and the Assessment Area One Project to the extent referred to in the Limited Offering Memoranda, conform in all material respects to the Assessment Area One Bonds, the Financing Documents, the Ancillary Agreements and the Assessment Area One Project, respectively;

(g) The Assessment Area One Bonds, when issued, executed and delivered in accordance with the Indenture and when sold to the Underwriter as provided herein, will be validly issued and outstanding obligations of the District, entitled to the benefits of the Indenture and upon such issuance, execution and delivery of the Assessment Area One Bonds, the Indenture will provide, for the benefit of the holders from time to time of the Assessment Area One Bonds, a legally valid and binding pledge of and first lien on the Assessment Area One Pledged Revenues. On the Closing Date, all conditions precedent to the issuance of the Assessment Area One Bonds set forth in the Indenture will have been complied with or fulfilled;

(h) As of the date hereof, there is no claim, action, suit, proceeding, inquiry or investigation, at law or in equity, before or by any court, government agency, public board or body, pending or, to its best knowledge, threatened against the District: (i) contesting the corporate existence or powers of the Board or the titles of the respective officers of the Board to their respective offices; (ii) affecting or seeking to prohibit, restrain or enjoin the sale, issuance or delivery of the Assessment Area One Bonds or the application of the proceeds of the sale thereof for the purposes described in the Limited Offering Memoranda or the collection of the Assessment Area One Special Assessments or the pledge of and lien on the Assessment Area One Pledged Revenues, pursuant to the Indenture; (iii) contesting or affecting specifically as to the District the validity or enforceability of the Act or any action of the District in any respect relating to the authorization for the issuance of the Assessment Area One Bonds, or the authorization of the Assessment Area One Project, the Bond Resolution, the Assessment Resolutions, the Financing Documents and Ancillary Agreements to which the District is a party, or the application of the proceeds of the Assessment Area One Bonds for the purposes set forth in the Limited Offering Memoranda; (iv) contesting the federal tax status of the Assessment Area One Bonds; or (v) contesting the completeness or accuracy of the Limited Offering Memoranda or any supplement or amendment thereto;

(i) To the extent applicable, the District will furnish such information, execute such instruments and take such other action in cooperation with the Underwriter as the Underwriter may reasonably request in order to: (i) qualify the Assessment Area One Bonds for offer and sale under the Blue Sky or other securities laws and regulations of such states and other jurisdictions of the United States as the Underwriter may designate; and (ii) determine the eligibility of the Assessment Area One Bonds for investment under the laws of such states and other jurisdictions, and the District will use its best efforts to continue such qualifications in effect so long as required for the initial limited offering and distribution of the Assessment Area One Bonds; provided, however, that the District shall not be required to execute a general or special consent to service of process or to qualify to do business in connection with any such qualification or determination in any jurisdiction or register as a broker/dealer;

(j) As of its date (unless an event occurs of the nature described in paragraph (1) of this Section 6) and at all times subsequent thereto, up to and including the date hereof the statements and information contained in the Preliminary Limited Offering Memorandum (other than Permitted Omissions) and in the Limited Offering Memorandum are and will be accurate in all material respects for the purposes for which their use is authorized and do not and will not contain any untrue statement of a material fact or omit to state a material fact necessary to make the statements made therein, in the light of the circumstances under which they were made, not misleading; provided, however, that no representation is made concerning information contained in the Limited Offering Memoranda under the captions "DESCRIPTION OF THE ASSESSMENT AREA ONE BONDS – Book-Entry Only System," "THE DEVELOPMENT," "THE DEVELOPER," "TAX MATTERS," "SUITABILITY FOR INVESTMENT," "LITIGATION – The Developer," "UNDERWRITING" and, with respect to the Developer, as set forth under the caption "CONTINUING DISCLOSURE";

(k) If the Limited Offering Memorandum is supplemented or amended pursuant to subsection (1) of this Section 6, at the time of each supplement or amendment thereto and (unless subsequently again supplemented or amended pursuant to such paragraph) at all times subsequent thereto up to and including the Closing Date, the Limited Offering Memorandum as so supplemented or amended will be accurate in all material respects for the purposes for which their use is authorized and will not contain any untrue statement of a material fact or omit to state a material fact necessary to make the statements therein, in the light of the circumstances under which they were made, not misleading; provided, however, that no representation is made concerning information contained in the Limited Offering Memoranda under the captions "DESCRIPTION OF THE ASSESSMENT AREA ONE BONDS – Book-Entry Only System," "THE DEVELOPMENT," "THE DEVELOPER," "TAX MATTERS," "SUITABILITY FOR INVESTMENT," "LITIGATION – The Developer," "UNDERWRITING" and, with respect to the Developer, as set forth under the caption "CONTINUING DISCLOSURE";

(l) If between the date of this Purchase Contract and the earlier of (i) the date that is ninety (90) days from the end of the "Underwriting Period" as defined in the Rule, or (ii) the time when the Limited Offering Memorandum is available to any person from the MSRB's Electronic Municipal Market Access system (but in no event less than twenty-five (25) days following the end of the Underwriting Period), any event shall occur, of which the District has actual knowledge, which might or would cause the Limited Offering Memorandum, as then supplemented or amended, to contain any untrue statement of a material fact or to omit to state a material fact necessary to make the statements therein, in the light of the circumstances under which they were made, not misleading, the District shall notify the Underwriter thereof, and, if in the opinion of the Underwriter such event requires the preparation and publication of a supplement or amendment to the Limited Offering Memorandum, the District will at its expense (unless such supplement or

amendment is the direct result of information provided by the Developer or Underwriter, then at the expense of said relevant person) supplement or amend the Limited Offering Memorandum in a form and in a manner approved by the Underwriter. The end of the Underwriting Period shall be the next business day after the Closing Date;

(m) Since its inception, there has been no material adverse change in the properties, businesses, results of operations, prospects, management or financial or other condition of the District, except as disclosed in the Limited Offering Memoranda, and the District has not incurred liabilities that would materially adversely affect its ability to discharge its obligations under the Bond Resolution, the Assessment Resolutions, the Assessment Area One Bonds, the Financing Documents or the Ancillary Agreements, direct or contingent, other than as set forth in or contemplated by the Limited Offering Memoranda;

(n) The District has not and is not now in default in the payment of the principal of or the interest on any governmental security issued or guaranteed by it after December 31, 1975 which would require the disclosure pursuant to Section 517.051, Florida Statutes or Rule 69W-400.003 of the Florida Department of Financial Services;

(o) The District has disclosed in the Preliminary Limited Offering Memorandum any failure in the previous five (5) years to comply, in all material respects, with any previous continuing disclosure obligations undertaken by the District in accordance with the continuing disclosure requirements of the Rule;

(p) Any certificate signed by any official of the District and delivered to the Underwriter will be deemed to be a representation by the District to the Underwriter as to the statements made therein; and

(q) From the date of this Purchase Contract through the Closing Date, the District will not issue any bonds (other than the Assessment Area One Bonds), notes or other obligations payable from the Assessment Area One Pledged Revenues.

7. **Closing.** At 10:00 a.m. prevailing time on [_____], 2023 (the "Closing Date") or at such later time as may be mutually agreed upon by the District and the Underwriter, the District will, subject to the terms and conditions hereof, deliver to the Underwriter, the Assessment Area One Bonds in definitive book-entry only form, duly executed and authenticated, together with the other documents hereinafter mentioned, and, subject to the terms and conditions hereof, the Underwriter will accept such delivery and pay the purchase price of the Assessment Area One Bonds as set forth in Section 1 hereof, in federal or other immediately available funds to the order of the District. Delivery of the Assessment Area One Bonds as aforesaid shall be made pursuant to the FAST system of delivery of The Depository Trust Company, New York, New York, or at such other place as may be mutually agreed upon by the District and the Underwriter. The Assessment Area One Bonds shall be typewritten, shall be prepared and delivered as fully registered bonds in book-entry only form, with one bond for each maturity, registered in the name of Cede & Co. and shall be made available to the Underwriter at least one (1) business day before the Closing Date for purposes of inspection and packaging, unless otherwise agreed by the District and the Underwriter.

8. **Closing Conditions.** The Underwriter has entered into this Purchase Contract in reliance upon the representations, warranties and agreements of the District contained herein, and in reliance upon the representations, warranties and agreements to be contained in the documents and instruments to be delivered on the Closing Date and upon the performance by the District of its obligations hereunder, both as of the date hereof and as of the Closing Date. Accordingly, the Underwriter's obligations under this Purchase Contract to purchase, to accept delivery of and to pay for the Assessment Area One Bonds are

conditioned upon the performance by the District of its obligations to be performed hereunder and under such documents and instruments at or prior to the Closing Date, and are also subject to the following additional conditions:

(a) The representations and warranties of the District contained herein shall be true, complete and correct, on the date hereof and on and as of the Closing Date, as if made on the Closing Date;

(b) At the time of the Closing, the Bond Resolution (including without limitation the Supplemental Bond Resolution), the Assessment Resolutions, the Assessment Area One Bonds, the Financing Documents and the Ancillary Agreements shall each be in full force and effect in accordance with their respective terms and the Bond Resolution, the Assessment Resolutions, the Indenture and the Limited Offering Memoranda shall not have been supplemented, amended, modified or repealed, except in any such case as may have been agreed to by the Underwriter;

(c) At or prior to the Closing Date, the Underwriter and the District shall have received each of the following:

(1) The Limited Offering Memorandum and each supplement or amendment, if any, thereto, executed on behalf of the District by the Chairperson of the Board or such other authorized member of the Board;

(2) A copy of each of the Bond Resolution (including the adopted Supplemental Bond Resolution) and the Assessment Resolutions certified by the Secretary or an Assistant Secretary of the Board under seal as having been duly adopted by the Board of the District and as being in full force and effect;

(3) Executed copies of each of the Financing Documents and Ancillary Agreements in form and substance acceptable to the Underwriter and Underwriter's counsel;

(4) The opinion, dated as of the Closing Date and addressed to the District, of Greenberg Traurig, P.A., Bond Counsel, in the form included in the Preliminary Limited Offering Memorandum as APPENDIX C or otherwise in form and substance acceptable to the Underwriter and Underwriter's Counsel, together with a letter of such counsel, dated as of the Closing Date and addressed to the Underwriter and the Trustee, to the effect that the foregoing opinion addressed to the District may be relied upon by the Underwriter and the Trustee to the same extent as if such opinion were addressed to them;

(5) The supplemental opinion, dated as of the Closing Date and addressed to the Underwriter, of Greenberg Traurig, P.A., Bond Counsel, in the form annexed as Exhibit C hereto or otherwise in form and substance acceptable to the Underwriter and Underwriter's Counsel;

(6) The opinion, dated as of the Closing Date of Kilinski | Van Wyk PLLC, counsel to the District, in the form annexed as Exhibit D hereto or in form and substance otherwise acceptable to the Underwriter and its counsel;

(7) An opinion, dated as of the Closing Date and addressed to the Underwriter, Underwriter's Counsel, the District and Bond Counsel, of counsel to the Trustee, in form

and substance acceptable to Bond Counsel, Underwriter, Underwriter's Counsel, and the District;

(8) A customary authorization and incumbency certificate, dated as of the Closing Date, signed by authorized officers of the Trustee in form and substance acceptable to the Underwriter and Underwriter's Counsel;

(9) The opinion, dated as of the Closing Date and addressed to the District, the Trustee and the Underwriter, of Johnson Pope Bokor Ruppel & Burns, LLP, counsel to the Developer, in the form annexed as Exhibit E hereto or in form and substance otherwise acceptable to the Underwriter and Underwriter's counsel;

(10) A certificate of the Developer dated as of the Closing Date, in the form annexed as Exhibit F hereto or otherwise in form and substance acceptable to the Underwriter and Underwriter's Counsel;

(11) A copy of the Ordinance;

(12) A certificate, dated as of the Closing Date, signed by the Chairperson or Vice-Chairperson and the Secretary or an Assistant Secretary of the Board, setting forth that: (i) each of the representations of the District contained herein was true and accurate in all material respects on the date when made, has been true and accurate in all material respects at all times since, and continues to be true and accurate in all material respects on the Closing Date as if made on such date; (ii) the District has performed all obligations to be performed hereunder as of the Closing Date; (iii) except as may be disclosed in the Limited Offering Memorandum, the District has never been in default as to principal or interest with respect to any obligation issued or guaranteed by the District; (iv) the District agrees to take all reasonable action necessary to use the Uniform Method as the means of collecting the Assessment Area One Special Assessments as described in the Indenture; and (v) the Limited Offering Memoranda (other than the information under the captions "DESCRIPTION OF THE ASSESSMENT AREA ONE BONDS – Book-Entry Only System," "THE DEVELOPMENT," "THE DEVELOPER," "TAX MATTERS," "SUITABILITY FOR INVESTMENT," "LITIGATION – The Developer," "UNDERWRITING" and, with respect to the Developer, as set forth under the caption "CONTINUING DISCLOSURE," as to which no view need be expressed) as of their respective dates, and as of the date hereof, do not contain any untrue statement of a material fact or omits to state a material fact which should be included therein for the purposes for which the Limited Offering Memoranda are to be used, or which is necessary in order to make the statements contained therein, in the light of the circumstances under which they were made, not misleading;

(13) A customary signature and no litigation certificate, dated as of the Closing Date, signed on behalf of the District by the Chairperson or Vice-Chairperson and Secretary or an Assistant Secretary of the Board in form and substance acceptable to the Underwriter and Underwriter's Counsel;

(14) Evidence of compliance by the District with the requirements of Section 189.051, Florida Statutes;

(15) Executed copies of the District's certification as to arbitrage and other matters relative to the tax status of the Assessment Area One Bonds under Section 148 of the Internal Revenue Code of 1986, as amended;

(16) Executed copy of Internal Revenue Service Form 8038-G relating to the Assessment Area One Bonds;

(17) A certificate of the District's consulting engineer, dated as of the Closing Date, in the form annexed as Exhibit G hereto or otherwise in form and substance acceptable to the Underwriter and Underwriter's Counsel;

(18) A certificate of the District Manager and Methodology Consultant in the form annexed as Exhibit H hereto or otherwise in form and substance acceptable to the Underwriter and Underwriter's Counsel;

(19) A certificate of the District whereby the District deemed the Preliminary Limited Offering Memorandum final for purposes of the Rule as of the date of the Preliminary Limited Offering Memorandum except for the Permitted Omissions;

(20) To the extent required under the Indenture, an investor letter from each initial beneficial owner of the Assessment Area One Bonds in the form attached to the Indenture;

(21) Such additional documents as may be required by the Indenture to be delivered as a condition precedent to the issuance of the Assessment Area One Bonds;

(22) Evidence of compliance by the District with the requirements of Section 215.84, Florida Statutes;

(23) A certified copy of the final judgment of the Ninth Judicial Circuit Court of Florida in and for Osceola County, Florida, validating the Assessment Area One Bonds and appropriate certificate of no-appeal;

(24) A copy of the Master Assessment Methodology for Hickory Tree Community Development District, dated June 28, 2022, as supplemented by the First Supplemental Assessment Methodology (2023 Project) for Hickory Tree Community Development District dated the date hereof, as the same may be amended and supplemented from time to time, relating to the Assessment Area One Bonds;

(25) A copy of "Hickory Tree Community Development District Engineer's Report" dated June 28, 2022, as supplemented by the [] dated [], 2023] (collectively, the "Engineer's Report");

(26) Acknowledgments in recordable form by all mortgage holders, if any, on lands which are subject to the Assessment Area One Special Assessments as to the superior lien of the Assessment Area One Special Assessments, in form and substance acceptable to the Underwriter and Underwriter's Counsel;

(27) Declaration of Consent to Jurisdiction of the District and to Imposition of Special Assessments by the Developer and any other landowners with respect to all real property which is subject to the Assessment Area One Special Assessments, each in

recordable form and otherwise in form and substance acceptable to the Underwriter and Underwriter's Counsel;

(28) Evidence acceptable to the Underwriter in its sole discretion that the District has engaged a dissemination agent acceptable to the Underwriter (the "Dissemination Agent") for the Assessment Area One Bonds;

(29) A certificate of the Dissemination Agent (i) acknowledging its agreement to serve as the initial Dissemination Agent for the District and undertake the obligations of the Dissemination Agent as set forth in the Continuing Disclosure Agreements (ii) representing that the Dissemination Agent is aware of the continuing disclosure requirements set forth in the Continuing Disclosure Agreements and the Rule and that it has policies and procedures in place to ensure its compliance with its obligations under the Disclosure Agreements, and (iii) covenanting to comply with its obligations under the Disclosure Agreements; and

(30) Such additional legal opinions, certificates, instruments and other documents as, the Underwriter, Underwriter's Counsel or Bond Counsel may reasonably request to evidence the truth and accuracy, as of the date hereof and as of the Closing Date, of the District's representations and warranties contained herein and of the statements and information contained in the Limited Offering Memoranda and the due performance or satisfaction by the District and the Developer on or prior to the Closing of all the agreements then to be performed and conditions then to be satisfied by each.

If the District shall be unable to satisfy the conditions to the obligations of the Underwriter to purchase, to accept delivery of and to pay for the Assessment Area One Bonds contained in this Purchase Contract (unless waived by the Underwriter in its sole discretion), or if the obligations of the Underwriter to purchase, to accept delivery of and to pay for the Assessment Area One Bonds shall be terminated for any reason permitted by this Purchase Contract, this Purchase Contract shall terminate and neither the Underwriter nor the District shall be under any further obligation hereunder, except that the respective obligations of the District and the Underwriter set forth in Section 10 hereof shall continue in full force and effect.

9. Termination. The Underwriter shall have the right to terminate its obligations under this Purchase Contract to purchase, to accept delivery of and to pay for the Assessment Area One Bonds by notifying the District in writing of its election to do so if, after the execution hereof and prior to the Closing: (i) legislation shall have been introduced in or enacted by the Congress of the United States or enacted by the State, or legislation pending in the Congress of the United States shall have been amended, or legislation shall have been recommended to the Congress of the United States or otherwise endorsed for passage (by press release, other form of notice or otherwise) by the President of the United States, the Treasury Department of the United States, the Internal Revenue Service or the Chairperson or ranking minority member of the Committee on Finance of the United States Senate or the Committee on Ways and Means of the United States House of Representatives, or legislation shall have been proposed for consideration by either such committee, by any member thereof, or legislation shall have been favorably reported for passage to either House of Congress of the United States by a committee of such House to which such legislation has been referred for consideration, or a decision shall have been rendered by a court of the United States or the State, including the Tax Court of the United States, or a ruling shall have been made or a regulation shall have been proposed or made or a press release or other form of notice shall have been issued by the Treasury Department of the United States, or the Internal Revenue Service or other federal or State authority, with respect to federal or State taxation upon revenues or other income of the general character to be derived by the District or by any similar body, or upon interest on obligations of the general character of the

Assessment Area One Bonds, which may have the purpose or effect, directly or indirectly, of materially and adversely affecting the tax exempt status of the District, its property or income, its securities (including the Assessment Area One Bonds) or the interest thereon, or any tax exemption granted or authorized by the State or, which in the reasonable opinion of the Underwriter, affects materially and adversely the market of the Assessment Area One Bonds, or the market price generally of obligations of the general character of the Assessment Area One Bonds; (ii) the District or the Developer has, without the prior written consent of the Underwriter, offered or issued any bonds, notes or other obligations for borrowed money, or incurred any material liabilities, direct or contingent, or there has been an adverse change of a material nature in the financial position, results of operations or condition, financial or otherwise, of the District or the Developer, other than in the ordinary course of their respective business; (iii) any event shall have occurred or shall exist which, in the reasonable opinion of the Underwriter, would or might cause the information contained in the Limited Offering Memorandum, as then supplemented or amended, to contain any untrue statement of a material fact or omit to state a material fact required to be stated therein or necessary to make the statements therein, in the light of the circumstances under which they were made, not misleading; or (iv) the District fails to adopt the Supplemental Bond Resolution, the Assessment Resolutions or fails to perform any action to be performed by it in connection with the levy of the Assessment Area One Special Assessments.

10. Expenses.

(a) The District agrees to pay, and the Underwriter shall not be obligated to pay, any expenses incident to the performance of the District's obligations hereunder, including, but not limited to: (i) the cost of the preparation and distribution of the Indenture; (ii) the cost of the preparation and printing, if applicable, of the Limited Offering Memoranda and any supplements thereto, together with a reasonable number of copies which the Underwriter may request; (iii) the cost of registering the Assessment Area One Bonds in the name of Cede & Co., as nominee of DTC, which will act as securities depository for such Assessment Area One Bonds; (iv) the fees and disbursements of counsel to the District, the District Manager, the Dissemination Agent, Bond Counsel, the Consulting Engineer, the Underwriter, Underwriter's Counsel, the District's Methodology Consultant and any other experts or consultants retained by the District; and (v) the cost of recording in the Official Records of the Osceola County, Florida (the "County") any Financing Documents, Ancillary Agreements or other documents or certificates that are required to be recorded pursuant to the terms of this Purchase Contract. It is anticipated that such expenses shall be paid from the proceeds of the Assessment Area One Bonds. The District shall submit for recording all documents required to be provided in recordable form hereunder within three business days after the Closing Date, which obligation shall survive the Closing.

(b) The Underwriter agrees to pay all advertising expenses in connection with the Assessment Area One Bonds, if any.

11. No Advisory or Fiduciary Role. The District acknowledges and agrees that (i) the purchase and sale of the Assessment Area One Bonds pursuant to this Agreement is an arm's-length commercial transaction between the District and the Underwriter, (ii) in connection with such transaction and with the discussions, undertakings and processes leading up to such transaction, the Underwriter is and has been acting solely as a principal and not as an advisor (including, without limitation, a Municipal Advisor (as such term is defined in Section 975(e) of the Dodd-Frank Wall Street Reform and Consumer Protection Act)), agent or a fiduciary of the District, (iii) the Underwriter has not assumed an advisory or a fiduciary responsibility in favor of the District with respect to the limited offering of the Assessment Area One Bonds or the discussions, undertakings and process leading thereto (whether or not the Underwriter, or any affiliate of the Underwriter, has provided or is currently advising or providing services to the District on other matters) or any other obligation to the District except the obligations expressly set forth in this Agreement, (iv) the Underwriter has financial and other interests that differ from those of the District, (v)

the District has consulted with its own legal and financial advisors to the extent it deemed appropriate in connection with the offering of the Assessment Area One Bonds, and (vi) the Underwriter has provided to the District prior disclosures under Rule G-17 of the MSRB, which have been received by the District.

12. Notices. Any notice or other communication to be given to the District under this Purchase Contract may be given by delivering the same in writing to the District Manager at Governmental Management Services – Central Florida, LLC, 219 E. Livingston Street, Orlando, Florida 32801, and any notice or other communication to be given to the Underwriter under this Purchase Contract may be given by delivering the same in writing to FMSbonds, Inc., 20660 W. Dixie Highway, North Miami Beach, Florida 33180, Attention: Jon Kessler.

13. Parties in Interest; Survival of Representations. This Purchase Contract is made solely for the benefit of the District and the Underwriter (including the successors or assigns of the Underwriter) and no other person shall acquire or have any right hereunder or by virtue hereof. All of the District's representations, warranties and agreements contained in this Purchase Contract shall remain operative and in full force and effect and survive the closing on the Assessment Area One Bonds, regardless of: (i) any investigations made by or on behalf of the Underwriter and (ii) delivery of and payment for the Assessment Area One Bonds pursuant to this Purchase Contract.

14. Effectiveness. This Purchase Contract shall become effective upon the execution by the appropriate officials of the District and shall be valid and enforceable at the time of such acceptance. To the extent of any conflict between the provisions of this Purchase Contract and any prior contract between the parties hereto, the provisions of this Purchase Contract shall govern.

15. Headings. The headings of the sections of this Purchase Contract are inserted for convenience only and shall not be deemed to be a part hereof.

16. Amendment. No modification, alteration or amendment to this Purchase Contract shall be binding upon any party until such modification, alteration or amendment is reduced to writing and executed by all parties hereto.

17. Governing Law. This Purchase Contract shall be governed and construed in accordance with the laws of the State.

18. Counterparts; Facsimile; PDF. This Purchase Contract may be signed in any number of counterparts with the same effect as if the signatures thereto and hereto were signatures upon the same instrument. Facsimile and pdf signatures shall be deemed originals.

[Signature page follows.]

Very truly yours,

FMSBONDS, INC.

By: _____
Theodore A. Swinarski
Senior Vice President - Trading

Accepted and agreed to this
____ day of _____, 2023.

**HICKORY TREE COMMUNITY
DEVELOPMENT DISTRICT**

By: _____
Milton Andrade, Chair, Board of
Supervisors

EXHIBIT A

DISCLOSURE AND TRUTH-IN-BONDING STATEMENT

[_____], 2023

Hickory Tree Community Development District
Osceola County, Florida

Re: \$[_____] Hickory Tree Community Development District Special Assessment Bonds,
Series 2023 (Assessment Area One Project) (the "Assessment Area One Bonds")

Dear Board of Supervisors:

Pursuant to Chapter 218.385, Florida Statutes, and with respect to the issuance of the above-referenced Bonds, FMSbonds, Inc. (the "Underwriter"), having purchased the Assessment Area One Bonds pursuant to a Bond Purchase Contract dated [_____], 2023 (the "Bond Purchase Contract"), by and between the Underwriter and Hickory Tree Community Development District (the "District"), furnishes the following information in connection with the limited offering and sale of the Assessment Area One Bonds. Capitalized terms used and not defined herein shall have the meanings given to them under the Bond Purchase Contract.

1. The total underwriting discount paid to the Underwriter pursuant to the Bond Purchase Contract for the Assessment Area One Bonds is approximately \$[_____] per \$1,000.00 or \$[_____].
2. There are no "finders" as such term is used in Sections 218.385 and 218.386, Florida Statutes, in connection with the issuance of the Assessment Area One Bonds.
3. The nature and estimated amounts of expenses to be incurred by the Underwriter in connection with the issuance of the Assessment Area One Bonds are set forth in Schedule I attached hereto.
4. The management fee charged by the Underwriter is: \$0/\$1,000 or \$0.
5. Any other fee, bonus or other compensation estimated to be paid by the Underwriter in connection with the Assessment Area One Bonds to any person not regularly employed or retained by the Underwriter in connection with the Assessment Area One Bonds to any person not regularly employed or retained by the Underwriter is as follows: None. GrayRobinson, P.A. has been retained as counsel to the Underwriter and will be compensated by the District.
6. Pursuant to the provisions of Sections 218.385(2) and (3), Florida Statutes, as amended, the following truth-in-bonding statements are made with respect to the Assessment Area One Bonds.

7. The address of the Underwriter is:

FMSbonds, Inc.
20660 W. Dixie Highway
North Miami Beach, Florida 33180

The District is proposing to issue \$[] aggregate amount of the Assessment Area One Bonds for the purposes of: (i) providing funds to pay all or a portion of the costs of the planning, financing, acquisition, construction, equipping and installation of the Assessment Area One Project, (ii) funding a deposit to the Assessment Area One Reserve Account in the amount of the Assessment Area One Reserve Requirement, (iii) paying a portion of the interest coming due on the Assessment Area One Bonds and (iv) paying the costs of issuance of the Assessment Area One Bonds. This debt or obligation is expected to be repaid over a period of approximately [] () years, [] () months, and [] () days. [There shall be no more than thirty (30) principal installments.] At a net interest cost of approximately []% for the Assessment Area One Bonds, total interest paid over the life of the Assessment Area One Bonds will be \$[].

The source of repayment for the Assessment Area One Bonds is the Assessment Area One Special Assessments, imposed and collected by the District. Based solely upon the assumptions set forth in the paragraph above, the issuance of the Assessment Area One Bonds will result in approximately \$[] (representing the average annual debt service payments due on the Assessment Area One Bonds) of the District's special assessment revenues not being available to the District on an annual basis to finance other services of the District each year for [] () years, [] () months, and [] () days; provided however, that in the event that the Assessment Area One Bonds were not issued, the District would not be entitled to impose and collect the Assessment Area One Special Assessments in the amount of the principal of and interest to be paid on the Assessment Area One Bonds.

[Remainder of page intentionally left blank.]

Sincerely,

FMSBONDS, INC.

By: _____
Theodore A. Swinarski
Senior Vice President - Trading

Schedule I
Expenses for Bonds:

<u>Expense</u>	<u>Amount</u>
DALCOMP	\$[_____]
Clearance	
CUSIP	
DTC	
FINRA/SIPC	
MSRB	
<u>Electronic Orders</u>	
TOTAL:	\$[_____]

EXHIBIT B

TERMS OF BONDS

1. **Purchase Price:** \$[_____] (representing the \$[_____] aggregate principal amount of the Assessment Area One Bonds, [plus/less net original issue premium/discount of \$[_____] and] less underwriter's discount of \$[_____]).
2. **Principal Amounts, Maturities, Interest Rates, Yields, and Prices:**

Assessment Area One Bonds				
<u>Amount</u>	<u>Maturity</u>	<u>Interest Rate</u>	<u>Yield</u>	<u>Price</u>

[*Yield calculated to the first optional call date of ____, 20__.]

The Underwriter has offered the Assessment Area One Bonds to the public on or before the date of this Purchase Contract at the initial offering prices set forth herein and has sold at least 10% of each maturity of the Assessment Area One Bonds to the public at a price that is no higher than such initial offering prices[, except for the following maturities: _____].

4. **Redemption Provisions:**

Optional Redemption

The Assessment Area One Bonds maturing after May 1, 20__ may, at the option of the District be called for redemption prior to maturity as a whole or in part, at any time, on or after May 1, 20__ (less than all Assessment Area One Bonds of a maturity to be selected by lot), at a Redemption Price equal to the principal amount of Assessment Area One Bonds to be redeemed, plus accrued interest from the most recent Interest Payment Date through which interest has been paid to the redemption date from moneys on deposit in the Assessment Area One Optional Redemption Subaccount of the Assessment Area One Bond Redemption Account. If such optional redemption shall be in part, the District shall select such principal amount of Assessment Area One Bonds to be optionally redeemed from each maturity so that debt service on the remaining Outstanding Assessment Area One Bonds is substantially level.

Mandatory Sinking Fund Redemption

The Assessment Area One Bonds maturing on May 1, 20__ are subject to mandatory sinking fund redemption from the moneys on deposit in the Assessment Area One Sinking Fund Account on May 1 in the years and in the mandatory sinking fund redemption amounts set forth below at a Redemption Price of 100% of their principal amount plus accrued interest to the date of redemption.

<u>Year</u>	<u>Mandatory Sinking Fund Redemption Amount</u>
*	\$

*Maturity

The Assessment Area One Bonds maturing on May 1, 20__ are subject to mandatory sinking fund redemption from the moneys on deposit in the Assessment Area One Sinking Fund Account on May 1 in the years and in the mandatory sinking fund redemption amounts set forth below at a Redemption Price of 100% of their principal amount plus accrued interest to the date of redemption.

<u>Year</u>	<u>Mandatory Sinking Fund Redemption Amount</u>
	\$

*

*Maturity

The Assessment Area One Bonds maturing on May 1, 20__ are subject to mandatory sinking fund redemption from the moneys on deposit in the Assessment Area One Sinking Fund Account on May 1 in the years and in the mandatory sinking fund redemption amounts set forth below at a Redemption Price of 100% of their principal amount plus accrued interest to the date of redemption.

<u>Year</u>	<u>Mandatory Sinking Fund Redemption Amount</u>
	\$

*

*Maturity

The Assessment Area One Bonds maturing on May 1, 20__ are subject to mandatory sinking fund redemption from the moneys on deposit in the Assessment Area One Sinking Fund Account on May 1 in the years and in the mandatory sinking fund redemption amounts set forth below at a Redemption Price of 100% of their principal amount plus accrued interest to the date of redemption.

<u>Year</u>	<u>Mandatory Sinking Fund Redemption Amount</u>
	\$

*

*Maturity

Upon any redemption of Assessment Area One Bonds other than in accordance with scheduled mandatory sinking fund redemption amounts, the District shall cause to be recalculated and delivered to the Trustee revised mandatory sinking fund redemption amounts recalculated so as to amortize the Outstanding principal amount of Assessment Area One Bonds in substantially equal annual installments of principal and interest (subject to rounding to Authorized Denominations of principal) over the remaining term of the Assessment Area One Bonds. The mandatory sinking fund redemption amounts as so recalculated shall not result in an increase in the aggregate of the mandatory sinking fund redemption amounts for all Assessment Area One Bonds in any year. In the event of a redemption or purchase occurring less than 45 days prior to a date on which a mandatory sinking fund redemption payment is due, the foregoing recalculation shall not be made to the mandatory sinking fund redemption amounts due in the year in which such redemption or purchase occurs, but shall be made to the mandatory sinking fund redemption amounts for the immediately succeeding and subsequent years.

Extraordinary Mandatory Redemption

The Assessment Area One Bonds are subject to extraordinary mandatory redemption prior to maturity by the District in whole or in part, on any date (other than in the case of clause (i) below, which extraordinary mandatory redemption in part must occur on a Quarterly Redemption Date), at a Redemption Price equal to 100% of the principal amount of the Assessment Area One Bonds to be redeemed, plus interest accrued to the redemption date, as follows:

(i) from Assessment Area One Prepayment Principal deposited into the Assessment Area One Prepayment Subaccount of the Assessment Area One Bond Redemption Account following the payment in whole or in part of Assessment Area One Special Assessments on any assessable property within the District in accordance with the provisions of the First Supplemental Indenture, together with any excess moneys transferred by the Trustee from the Assessment Area One Reserve Account to the Assessment Area One Prepayment Subaccount as a result of such Prepayment and pursuant the First Supplemental Indenture. If such redemption shall be in part, the District shall select such principal amount of Assessment Area One Bonds to be redeemed from each maturity so that debt service on the remaining Outstanding Assessment Area One Bonds is substantially level;

(ii) from moneys, if any, on deposit in the Funds, Accounts and subaccounts held by the Trustee within the First Supplemental Indenture (other than the Assessment Area One Rebate Fund and the Assessment Area One Acquisition and Construction Account) sufficient to pay and redeem all Outstanding Assessment Area One Bonds and accrued interest thereon to the redemption date or dates in addition to all amounts owed to Persons under the Master Indenture; and

(iii) upon the Completion Date, from any funds remaining on deposit in the Assessment Area One Acquisition and Construction Account in accordance with the provisions of the First Supplemental Indenture, not otherwise reserved to complete the Assessment Area One Project and transferred to the Assessment Area One General Redemption Subaccount of the Assessment Area One Bond Redemption Account, together with moneys deposited therein in accordance with the provisions of the First Supplemental Indenture, as a result of the reduction of the Assessment Area One Reserve Requirement. If such redemption shall be in part, the District shall select such principal amount of Assessment Area One Bonds to be redeemed from each maturity so that debt service on the remaining Outstanding Assessment Area One Bonds is substantially level.

EXHIBIT C

BOND COUNSEL'S SUPPLEMENTAL OPINION

[_____], 2023

Hickory Tree Community Development District
Osceola County, Florida

FMSbonds, Inc.
North Miami Beach, Florida

Re: \$[_____] Hickory Tree Community Development District Special Assessment Bonds,
Series 2023 (Assessment Area One Project) (the "Assessment Area One Bonds")

Ladies and Gentlemen:

We have acted as Bond Counsel to Hickory Tree Community Development District (the "District"), a community development district established and existing pursuant to Chapter 190 of the Florida Statutes, as amended (the "Act"), in connection with the issuance by the District of its \$[_____] original aggregate principal amount of Hickory Tree Community Development District Special Assessment Bonds, Series 2023 (Assessment Area One Project) (the "Assessment Area One Bonds"). In such capacity, we have rendered our final approving opinion (the "Opinion") of even date herewith relating to the Assessment Area One Bonds. The Assessment Area One Bonds are secured pursuant to that certain Master Trust Indenture dated [_____] 1, 2023 (the "Master Indenture"), as supplemented and amended by that certain First Supplemental Trust Indenture, dated as of [_____] 1, 2023 (the "First Supplemental Indenture" and, together with the Master Indenture, the "Assessment Area One Indenture") by and between the District and U.S. Bank Trust Company, National Association, as trustee (the "Trustee").

In connection with the rendering of the Opinion, we have reviewed records of the acts taken by the District in connection with the authorization, sale and issuance of the Assessment Area One Bonds, were present at various meetings and participated in various discussions in connection therewith and have reviewed such other documents, records and other instruments as we deem necessary to deliver this opinion.

The District has entered into a Bond Purchase Contract dated [_____] 1, 2023 (the "Purchase Agreement"), for the purchase of the Assessment Area One Bonds. Capitalized words used, but not defined, herein shall have the meanings ascribed thereto in the Purchase Agreement.

Based upon the forgoing, we are of the opinion that:

1. The sale of the Assessment Area One Bonds by the District is not subject to the registration requirements of the Securities Act of 1933, as amended (the "Securities Act"), pursuant to the exemption provided in Section 3(a)(2) of the Securities Act.
2. The Assessment Area One Indenture is exempt from qualification pursuant to the Trust Indenture Act of 1939, as amended.
3. The information in the Limited Offering Memorandum under the captions "INTRODUCTION," "DESCRIPTION OF THE ASSESSMENT AREA ONE BONDS" and "SECURITY FOR AND SOURCE OF PAYMENT OF THE ASSESSMENT AREA ONE BONDS," insofar as such

statements constitute descriptions of the Assessment Area One Bonds or the Assessment Area One Indenture, are accurate as to the matters set forth or documents described therein (provided, we express no opinion with respect to any financial, statistical and demographic information and information under the caption "DESCRIPTION OF THE ASSESSMENT AREA ONE BONDS – Book-Entry Only System," and any other information in the Limited Offering Memoranda concerning DTC and its book-entry system of registration), and the information under the captions "TAX MATTERS" and "AGREEMENT BY THE STATE" are correct as to matters of law.

This letter is furnished by us as Bond Counsel. No attorney-client relationship has existed or exists between our firm and FMSbonds, Inc. (the "Underwriter") in connection with the Assessment Area One Bonds or by virtue of this letter. This letter is delivered to the Underwriter solely for its benefit as Underwriter and may not be used, circulated, quoted or otherwise referred to or relied upon by the Underwriter for any other purpose or by any other person other than the addressee hereto. This letter is not intended to, and may not be, relied upon by holders of the Assessment Area One Bonds.

Very truly yours,

EXHIBIT D

ISSUER'S COUNSEL'S OPINION

[_____], 2023

Hickory Tree Community Development District
Osceola County, Florida

FMSbonds, Inc.
North Miami Beach, Florida

U.S. Bank Trust Company, National Association
Fort Lauderdale, Florida
(solely for reliance upon Sections C.1., C.2. and C.3)

Re: \$[_____] Hickory Tree Community Development District Special Assessment Bonds,
Series 2023 (Assessment Area One Project)

Ladies and Gentlemen:

We serve as counsel to the Hickory Tree Community Development District (the "District"), a local unit of special-purpose government established pursuant to the laws of the State of Florida, in connection with the sale by the District of its \$[_____] Hickory Tree Community Development District Special Assessment Bonds, Series 2023 (Assessment Area One Project) (the "Assessment Area One Bonds"). This letter is delivered to you pursuant to Section 3.01(3) of the Master Indenture (defined below), Section 2.09(c) of the First Supplemental Trust Indenture (defined below), and Section 8(c)(6) of the Bond Purchase Contract (referenced below), and is effective as of the date first written above. Each capitalized term not otherwise defined herein has the meaning given it to it in the Indenture (defined herein).

A. DOCUMENTS EXAMINED

In rendering the opinions set forth below, we have examined and/or relied upon the following documents and have made such examination of law as we have deemed necessary or appropriate:

1. Ordinance No. 2022-60, which was enacted by the Board of County Commissioners of Osceola County, Florida (the "**County**") on June 27, 2022, which became effective on June 29, 2022 (the "**Establishment Ordinance**");
2. the *Master Trust Indenture*, dated as of [_____] 1, 2023 ("**Master Indenture**"), as supplemented with respect to the Assessment Area One Bonds by the *First Supplemental Trust Indenture*, dated as of [_____] 1, 2023 ("**First Supplemental Trust Indenture**" and, together with the Master Indenture, "**Indenture**"), each by and between the District and U.S. Bank Trust Company, National Association, as trustee ("**Trustee**");
3. Resolutions Nos. 2022-26 and 2023-[__] adopted by the District on July 14, 2022 and [September 6], 2023, respectively (collectively, "**Bond Resolution**");
4. "*Hickory Tree Community Development District Engineer's Report*" dated June 28, 2022, as supplemented by the " _____ " dated [_____], 2023 (the "**Engineer's Report**"), which describes among other things, the capital infrastructure improvements for the District (the "**Assessment Area One Project**");
5. *Master Assessment Methodology for Hickory Tree Community Development District* dated June 28, 2022, as supplemented by the *First Supplemental Assessment Methodology for*

- Hickory Tree Community Development District* dated [____], 2023 (collectively, "**Assessment Methodology**");
6. Resolution Nos. 2022-27, 2022-28 and 2022-36, adopted by the District on July 14, 2022, July 14, 2022 and September 8, 2022, respectively (collectively, "Assessment Resolution"), establishing the debt service special assessments ("Debt Assessments"), securing the Assessment Area One Bonds;
 7. the *Final Judgment* issued on December 20, 2022, by the Circuit Court for the Ninth Judicial Circuit in and for Osceola County, Florida in Case No. 49-2022-CA-001986-OC and the Certificate of No Appeal issued thereafter;
 8. the Preliminary Limited Offering Memorandum dated [____], 2023 ("**PLOM**") and Limited Offering Memorandum dated [____], 2023 ("**LOM**");
 9. certain certifications by FMSbonds, Inc. ("**Underwriter**"), as underwriter to the sale of the Assessment Area One Bonds;
 10. certain certifications of Dewberry Engineers Inc., as District Engineer;
 11. certain certifications of Governmental Management Services – Central Florida, LLC, as Methodology Consultant;
 12. certain certifications of Governmental Management Services – Central Florida, LLC, as District Manager;
 13. general and closing certificate of the District;
 14. an opinion of Greenberg Traurig, P.A. ("**Bond Counsel**"), issued to the District in connection with the sale and issuance of the Assessment Area One Bonds;
 15. an opinion of Aponte & Associates Law Firm, P.L.L.C. ("**Trustee Counsel**"), issued to the District and Underwriter in connection with the sale and issuance of the Assessment Area One Bonds;
 16. an opinion of Johnson Pope Bokor Ruppel & Burns, LLP, counsel to the Developer (defined herein), issued to the District and the Underwriter in connection with the sale and issuance of the Assessment Area One Bonds;
 17. the following agreements ("**Bond Agreements**"):
 - (a) the Continuing Disclosure Agreement dated [____], 2023, by and among the District and Clayton Properties Group, Inc. ("**Developer**"), and a dissemination agent;
 - (b) the Bond Purchase Contract between Underwriter and the District and dated [____], 2023 ("**BPA**");
 - (c) the Acquisition Agreement (Assessment Area One Bonds), between the District and the Developer and dated [____], 2023;
 - (d) the Completion Agreement (Assessment Area One Bonds), between the District and the Developer and dated [____], 2023;
 - (e) the True-Up Agreement (Assessment Area One Bonds), between the District and the Developer and dated [____], 2023;
 - (f) the Collateral Assignment and Assumption Agreement (Assessment Area One Bonds), between the District and the Developer and dated [____], 2023;
 18. Declaration of Consent to Jurisdiction executed by the Developer;
 19. Certificate of the Developer; and
 20. Such other documents as we have deemed necessary or appropriate in rendering the opinions set forth below.

We have also attended various meetings of the District and have participated in conferences from time to time with representatives of the District, the District Engineer, the District Manager, the Assessment Consultant, the Underwriter, Bond Counsel, counsel to the Underwriter, the Developer, counsel to the Developer, and others relative to the Limited Offering Memorandum and the related documents described herein.

B. RELIANCE

This opinion is solely for the benefit of the (i) District; (ii) Underwriter; and (iii) Trustee; however, the Trustee may only rely on this opinion for the limited purposes of the opinions stated in Sections C.1, C.2 and C.3. This opinion may not be relied on by any other party or for any other purpose without our prior written consent.

C. OPINIONS

Based on the foregoing, and subject to the qualifications and assumptions set forth herein, we are of the opinion that:

1. **Authority** – Under the Florida Constitution and laws of the State, the District has been duly established and validly exists as a local unit of special purpose government and a community development district under Chapter 190, Florida Statutes (the "Act"), with such powers as set forth in the Act, and with good, right and lawful authority: (a) to enter into and to consummate the transactions contemplated by the Bond Resolution, the Assessment Resolution, the Indenture, the Assessment Area One Bonds and the Bond Agreements; (b) to issue the Assessment Area One Bonds for the purposes for which they are issued; (c) to impose, levy, collect and enforce the Debt Assessments and pledge the Pledged Revenues to secure the Assessment Area One Bonds as provided in the Indenture; (d) to adopt the Bond Resolution and the Assessment Resolution; and (e) to perform its obligations under the terms and conditions of the Bond Resolution, the Assessment Resolution, the Bond Agreements, the Assessment Area One Bonds and the Indenture.

2. **Assessments** – The proceedings by the District with respect to the Debt Assessments have been in accordance with Florida law. The District has taken all action necessary to levy and impose the Debt Assessments as set forth in the Assessment Resolution, Assessment Methodology, and/or other applicable documents. The Debt Assessments constitute legal, valid, binding and enforceable first liens upon the property against which such Debt Assessments are assessed, co-equal with the lien of all state, county, district and municipal taxes and assessments, and superior in dignity to all other liens, titles and claims, until paid.

3. **Agreements** – The (a) Bond Resolution, (b) Assessment Resolution, (c) Bonds, (d) Indenture, and (e) Bond Agreements (assuming due authorization, execution and delivery of documents (c) – (e) listed herein by any parties thereto other than the District) have been duly and validly authorized, executed and delivered by the District, have been duly approved and adopted and/or issued by the District, are in full force and effect, constitute legal, valid and binding obligations of the District, and are enforceable against the District in accordance with their respective terms. All conditions prescribed in the Indenture as precedent to the issuance of the Assessment Area One Bonds have been fulfilled.

4. **Validation** – The Assessment Area One Bonds have been validated by a final judgment of the Circuit Court in and for Osceola County, Florida, of which no timely appeals were filed.

5. **Governmental Approvals** – As of the date hereof, all necessary consents, approvals, waivers or other actions by or filings with any governmental authority or other entity that are required for: (a) the adoption of the Bond Resolution and the Assessment Resolution; (b) the issuance, sale, execution and delivery of the Assessment Area One Bonds upon the terms set forth in the BPA, PLOM, and LOM; (c) the execution and delivery of the Indenture and Bond Agreements; and (d) the performance by the District of the transactions required hereby, have been duly obtained or made and are in full force and effect.

6. ***PLOM and LOM*** – The District has duly authorized the execution, delivery and distribution by the Underwriter of the PLOM and LOM. To our knowledge, and based upon our review of the PLOM and LOM and without having undertaken to determine independently the accuracy, completeness or fairness of the statements contained in the PLOM and LOM, and as of the date of their respective issuances, and with respect to the PLOM, the date of the BPA, and with respect to the LOM, the date hereof, nothing has come to our attention which would lead us to believe that the PLOM and LOM contain an untrue statement of a material fact or omit to state a material fact necessary to make the statements contained therein, in light of the circumstances under which they were made, not misleading, provided however that the opinions stated herein extend only to the following provisions of the PLOM and LOM: "SECURITY FOR AND SOURCE OF PAYMENT OF THE ASSESSMENT AREA ONE BONDS – Prepayment of Assessment Area One Special Assessments" (as to the first two paragraphs thereof), "ENFORCEMENT OF ASSESSMENT COLLECTIONS," "THE DISTRICT" (excluding the subcaption "The District Manager and Other Consultants"), "THE DEVELOPMENT – Developer Agreements" (solely as to the description of the agreements), "AGREEMENT BY THE STATE," "LEGALITY FOR INVESTMENT," "LITIGATION – The District," "CONTINUING DISCLOSURE" (as it relates to the District only), "VALIDATION," and "AUTHORIZATION AND APPROVAL," and further provided however that the opinions stated herein do not extend to any statements that constitute descriptions of the Assessment Area One Bonds or the Indenture. No information or opinion is offered as to any remaining provisions of the PLOM or LOM.

7. ***Litigation*** – As the District's Registered Agent for service of process and the fact that we have not been served with notice, there is no litigation pending or, to the best of our knowledge, threatened against the District: (a) seeking to restrain or enjoin the issuance or delivery of the Assessment Area One Bonds or the application of the proceeds thereof, or the imposition, levy or collection of the Debt Assessments or the Pledged Revenues pledged for the payment of the debt service on the Assessment Area One Bonds; (b) contesting or affecting the authority for the Debt Assessments, the authority for the issuance of the Assessment Area One Bonds or the validity or enforceability of the Assessment Area One Bonds, the Indenture, the Bond Agreements or the transactions contemplated thereunder; (c) contesting or affecting the establishment or existence of the District or any of its Supervisors, officers or employees, its assets, property or condition, financial or otherwise, or contesting or affecting any of the powers of the District, including its power to enter into the Indenture or the Bond Agreements, or its power to determine, assess, levy, collect and pledge the Debt Assessments for the payment of the debt service on the Assessment Area One Bonds; or (d) specifically contesting the exclusion from federal gross income of interest on the Assessment Area One Bonds.

8. ***Compliance with Laws*** – To the best of our knowledge, the District is not, in any manner material to the issuance of the Assessment Area One Bonds or the Debt Assessments, in breach of or default under any applicable provision of the Act or constitutional provision, statute, or administrative regulation of the State of Florida, or any applicable judgment or decree, any loan agreement, indenture, bond, note, resolution, agreement (including the Bond Agreements and Indenture), or any other material instrument to which the District is a party or to which the District or any of its property or assets is otherwise subject, and to the best of our knowledge, no event has occurred and is continuing which with the passage of time or the giving of notice, or both, would constitute a material default or event of default by the District under any such instrument; provided, however, that no opinion is expressed as to compliance with any state or federal tax or securities laws.

9. ***Authority to Undertake Assessment Area One Project*** – The District has good right and lawful authority under the Act to undertake, finance, acquire, construct, own, and operate the Assessment Area One Project, subject to obtaining such licenses, orders or other authorizations as are, at the date of such opinion, required to be obtained from any agency or regulatory body.

D. CERTAIN ASSUMPTIONS

In rendering the foregoing opinions, we have assumed the following: (1) that all public records, certifications, agreements and other documents examined by us that have been executed or certified by public officials acting within the scope of their official capacities are authentic, truthful and accurate; (2) that copies of such public records, certifications, agreements, and other documents furnished to us are authentic and conform to the originals; (3) that all signatures on executed public records, certifications, agreements and other documents are genuine; and (4) that all public records, certifications, agreements and other documents have been properly authorized and are binding on each of the other parties thereto; and (5) the continued application of the legislative determinations of the District's Board of Supervisors. Such assumptions do not apply to District documents.

E. CERTAIN QUALIFICATIONS

The foregoing opinions are subject to the following qualifications:

1. The opinions or statements expressed above are based solely on the laws of Florida in effect at the time of issuance of the Assessment Area One Bonds. Accordingly, we express no opinion nor make any statement regarding the effect or application of the laws of the federal government (including but not limited to the Internal Revenue Code or any proposed changes thereto), or any other state or other jurisdiction.

2. Our opinion as to enforceability of any document is subject to limitations imposed by bankruptcy, insolvency, reorganization, moratorium, liquidation, readjustment of debt, or similar laws, relating to or affecting creditors' rights generally and general principles of equity (regardless of whether such enforceability is considered in a proceeding in equity or at law), and to the exercise of judicial discretion in appropriate cases, including the fact that specific performance and other equitable remedies are granted only in the discretion of a court.

3. Nothing herein shall be construed as an opinion regarding the possible applicability of state securities or "blue sky" laws or federal securities laws, as to which no opinion is expressed.

4. We further express no opinion as to the necessity for an interest rate waiver under Florida law, or the applicability of any provision or section of the Internal Revenue Code. We express no opinion as to compliance with any state or federal tax laws.

5. We express no opinion and make no representations regarding financial information, statistical data, or assessment and benefit calculations.

6. We have not reviewed, and therefore express no opinion, regarding any land use, real property or other related items, including but not limited to whether the Developer is able to convey good and marketable title to any particular real property or interest therein and related to the Assessment Area One Project.

7. With respect to any of the opinions set forth in this letter which are based on or qualified by the phrase "to our knowledge," the words "to our knowledge" signify that, in the course of our representation of the District, no facts have come to our attention that would give us actual knowledge that any such opinions or other matters are not accurate. Except to the extent expressly set forth herein, we have not undertaken any independent investigation to determine the existence or absence of any such facts, and no inference as to our knowledge of the existence of such facts should be drawn from the fact of our representation of District.

8. The opinions set forth herein are based on factual representations made to us as of the date hereof. We assume no duty to update or supplement our opinions to reflect any facts or circumstances that may thereafter come to our attention, or to reflect any changes in law that may thereafter occur or become effective. Moreover, our opinions are not a guarantee of a particular result, and are not binding on the courts or any other entity; rather, our opinions represent our professional judgment based on our review of existing law, and in reliance on the representations and covenants that we deem relevant to such opinions

Very truly yours,

KILINSKI | VAN WYK PLLC

EXHIBIT E

DEVELOPER'S COUNSEL'S OPINION

[_____], 2023

Hickory Tree Community Development District
Osceola County, Florida

FMSbonds, Inc.
North Miami Beach, Florida

U.S. Bank Trust Company, National Association
Fort Lauderdale, Florida

Greenberg Traurig, P.A.
Miami, Florida

GrayRobinson, P.A.
Tampa, Florida

Re: \$[_____] Hickory Tree Community Development District Special Assessment Bonds,
 Series 2023 (Assessment Area One Project) (the "Assessment Area One Bonds")

Ladies and Gentlemen:

I am counsel to Clayton Properties Group, Inc., a Tennessee corporation (the "Developer"), which is the owner and developer of certain land located in Osceola County, Florida and being developed as a residential community to be known as "Hickory Tree," as such lands are described in the Limited Offering Memoranda (as hereinafter defined). This opinion is rendered at the request of the Developer in connection with the issuance by the Hickory Tree Community Development District (the "District") of the above-referenced Bonds, as further described in the District's Preliminary Limited Offering Memorandum dated [_____] , 2023 and the District's final Limited Offering Memorandum, dated [_____] , 2023, including the appendices attached thereto (collectively, the "Limiting Offering Memoranda"). Capitalized terms not defined herein shall have the meaning set forth in the Limited Offering Memoranda.

It is my understanding that the Assessment Area One Bonds are being issued for the purposes of: (i) providing funds to pay a portion of the costs of the planning, financing, acquisition, construction, equipping and installation of the Assessment Area One Project, (ii) funding a deposit to the Assessment Area One Reserve Account in the amount of the Assessment Area One Reserve Requirement, (iii) paying a portion of the interest coming due on the Assessment Area One Bonds and (iv) paying the costs of issuance of the Assessment Area One Bonds.

In my capacity as counsel to the Developer, I have examined originals or copies identified to my satisfaction as being true copies of the Limiting Offering Memoranda, the Continuing Disclosure Agreement to be dated as of the Closing Date (the "Continuing Disclosure Agreement"), by and among the District, the Developer, and Governmental Management Services – Central Florida, LLC, as dissemination agent, the Agreement Regarding the Completion of Certain Improvements by and between the District and the Developer dated as of the Closing Date (the "Completion Agreement"), the Agreement Regarding the

Acquisition of Work Product, Improvements and Real Property by and between the District and the Developer dated as of the Closing Date (the "Acquisition Agreement"), the Collateral Assignment and Assumption of Development Rights by and between the District and the Developer dated as of the Closing Date (the "Collateral Assignment"), the Agreement Regarding True-Up by and between the District and the Developer dated as of the Closing Date (the "True-Up Agreement"), and the Declaration of Consent to Jurisdiction of the District, Imposition of Special Assessments and Imposition of Lien of Record dated as of the Closing Date and executed by the Developer (the "Declaration of Consent") (collectively, the "Documents") and have made such examination of law as I have deemed necessary or appropriate in rendering this opinion. In connection with the forgoing, I also have reviewed and examined the By-Laws of the Developer dated as of September 1, 1988, the Developer's corporate Charter filed on September 1, 1988, and certificates of good standing issued by the State of Tennessee and the State of Florida on _____, 20__ and _____, 20__, respectively (collectively, the "Organizational Documents").

In rendering this opinion, I have assumed, without having made any independent investigation of the facts, the genuineness of all signatures (other than those of the Developer) and the authenticity of all documents submitted to me as originals and the conformity to original documents of all documents submitted to me as certified, conformed or photostatic copies, and the legal capacity of all natural persons.

In basing the opinions set forth in this opinion on "my knowledge," the words "my knowledge" signify that, in the course of my representation of Developer, no facts have come to my attention that would give me actual knowledge or actual notice that any such opinions or other matters are not accurate. Except as otherwise stated in this opinion, I have undertaken no investigation or verification of such matters.

Based on the forgoing, I am of the opinion that:

1. The Developer is a corporation organized and existing under the laws of the State of Tennessee and duly authorized to do business in the State of Florida.
2. The Developer has the power to conduct its business and to undertake the funding of the development of the lands in the District as described in the Limited Offering Memoranda and to enter into the Documents.
3. The Documents have been duly authorized, executed and delivered by the Developer and are in full force and effect. Assuming the due authorization, execution and delivery of such instruments by the other parties thereto and their authority to perform such instruments, the Documents constitute legal, valid and binding obligations of the Developer, enforceable in accordance with their respective terms.
4. Nothing has come to my attention that would lead me to believe the information contained in the Limited Offering Memoranda under the captions "THE DEVELOPMENT," "THE DEVELOPER," "LITIGATION – The Developer" and "CONTINUING DISCLOSURE" (as it relates to the Developer only) does not accurately and fairly present the information purported to be shown or contains any untrue statement of a material fact nor omits to state any material fact necessary to make the statement made therein, in light of the circumstances under which they were made, not misleading as of the dates of the Limited Offering Memoranda or as of the date hereof.
5. The execution, delivery and performance of the Documents by the Developer do not violate (i) the Organizational Documents of the Developer, (ii) to my knowledge, any agreement, instrument or Federal or Florida law, rule or regulation known to me to which the Developer is a party or by which any of the Developer's assets are or may be bound; or (iii) to my knowledge, any judgment, decree or order of any administrative tribunal, which judgment, decree, or order is binding on the Developer or its assets.

6. Nothing has come to my attention that would lead me to believe that the Developer is not in compliance in all material respects with all provisions of applicable law in all material matters relating to such entity as described in the Limited Offering Memoranda. Except as otherwise described in the Limited Offering Memoranda, (a) I have no knowledge that the Developer has not received all government permits, consents and licenses required in connection with the construction and completion of the development of the Assessment Area One Project and the lands in Assessment Area One as described in the Limited Offering Memoranda; (b) I have no knowledge of any default of any zoning condition, land use permit or development agreement which would adversely affect the Developer's ability to complete development of the Assessment Area One Project and the lands in Assessment Area One as described in the Limited Offering Memoranda and all appendices thereto; and (c) I have no knowledge and am not otherwise aware of any reason to believe that any permits, consents and licenses required to complete the Assessment Area One Project or the development of the lands in Assessment Area One as described in the Limited Offering Memoranda will not be obtained in due course as required by the Developer.

7. To the best of my knowledge after due inquiry, the levy of the Assessment Area One Special Assessments on the applicable lands within the District will not conflict with or constitute a breach of or default under any agreement, indenture or other instrument to which the Developer is a party or to which the Developer or any of its property or assets are subject.

8. To the best of my knowledge after due inquiry, there is no litigation pending which would prevent or prohibit the development of the Assessment Area One Project or the lands in Assessment Area One in accordance with the descriptions thereof in the Limited Offering Memoranda and the Engineer's Report annexed thereto or which may result in any material adverse change in the business, properties, assets or financial condition of the Developer.

9. To the best of my knowledge after due inquiry, the Developer has not made an assignment for the benefit of creditors, filed a petition in bankruptcy, petitioned or applied to any tribunal for the appointment of a custodian, receiver or any trustee or commenced any proceeding under any bankruptcy, reorganization, arrangement, readjustment of debt, dissolution or liquidation law or statute of any jurisdiction. To the best of my knowledge after due inquiry, the Developer has not indicated its consent to, or approval of, or failed to object timely to, any petition in bankruptcy, application or proceeding or order for relief or the appointment of a custodian, receiver or any trustee.

10. To the best of my knowledge after due inquiry, the Developer is in default under any mortgage, trust indenture, lease or other instrument to which it or any of its assets are subject, which default would have a material adverse effect on the Assessment Area One Bonds or the development of the Assessment Area One Project or the lands in Assessment Area One.

This opinion is given as of the date hereof, and I disclaim any obligation to update this opinion letter for events occurring after the date of this opinion letter. The foregoing opinion applies only with respect to the laws of the State of Florida and the federal laws of the United States of America and I express no opinion with respect to the laws of any other jurisdiction. Nothing herein shall be construed as an opinion regarding the possible applicability of state securities or "blue sky" laws, as to which no opinion is expressed. This letter is for the benefit of and may be relied upon solely by the addressees and this opinion may not be relied upon in any manner, nor used, by any other persons or entities.

My opinion as to enforceability of any document is subject to limitations imposed by bankruptcy, insolvency, reorganization, moratorium, liquidation, readjustment of debt, or similar laws relating to or affecting creditor's rights generally and general principles of equity (regardless of whether such enforceability is considered in a proceeding in equity or at law), and to the exercise of judicial discretion in appropriate cases.

Very truly yours,

JOHNSON POPE BOKOR RUPPEL & BURNS, LLP

EXHIBIT F

FORM OF CERTIFICATE OF DEVELOPER

Clayton Properties Group, Inc., a Tennessee corporation (the "Developer"), DOES HEREBY CERTIFY, that:

1. This Certificate of the Developer is furnished pursuant to Section 8(c)(10) of the Bond Purchase Contract dated [____], 2023 (the "Purchase Contract") between Hickory Tree Community Development District (the "District") and FMSbonds, Inc. (the "Underwriter") relating to the sale by the District of its \$[____] original aggregate principal amount of Hickory Tree Community Development District Special Assessment Bonds, Series 2023 (Assessment Area One Project) (the "Assessment Area One Bonds"). Capitalized terms used, but not defined, herein shall have the meaning assigned thereto in the Purchase Contract.

2. The Developer is a limited liability company organized and existing under the laws of the State of Tennessee and authorized to conduct business in the State of Florida.

3. Representatives of the Developer have provided information to the District to be used in connection with the offering by the District of its Assessment Area One Bonds, pursuant to a Preliminary Limited Offering Memorandum dated [____], 2023 and the Limited Offering Memorandum, dated [____], 2023, including the appendices attached thereto (collectively, the "Limited Offering Memoranda").

4. The Continuing Disclosure Agreement to be dated as of [____, 2023] (the "Closing Date"), by and among the District, the Developer, and Governmental Management Services – Central Florida, LLC, as dissemination agent, the Agreement Regarding the Completion of Certain Improvements by and between the District and the Developer dated as of the Closing Date, the Agreement Regarding the Acquisition of Work Product, Improvements and Real Property by and between the District and the Developer dated as of the Closing Date, the Collateral Assignment and Assumption of Development Rights by and between the District and the Developer dated as of the Closing Date, the Agreement Regarding True-Up by and between the District and the Developer dated as of the Closing Date (the "True-Up Agreement"), and the Declaration of Consent to Jurisdiction of Hickory Tree Community Development District and to Imposition of Special Assessments dated the Closing Date, executed by the Developer and to be recorded in the public records of Osceola County, Florida, constitute valid and binding obligations of the Developer, enforceable against the Developer in accordance with their respective terms.

5. The Developer has reviewed and approved the information contained in the Limited Offering Memoranda under the captions "THE CAPITAL IMPROVEMENT PLAN AND THE ASSESSMENT AREA ONE PROJECT," "THE DEVELOPMENT," "THE DEVELOPER," "BONDOWNERS' RISKS" (as it relates to the Developer, the Development and non-specific Bondholder risks), "LITIGATION – The Developer" and "CONTINUING DISCLOSURE" (as it relates to the Developer) and warrant and represent that such information did not as of their respective dates, and does not as of the date hereof, contain any untrue statement of a material fact or omit to state a material fact necessary to make the statements therein, in the light of the circumstances under which they were made, not misleading. In addition, the Developer is not aware of any other information in the Limited Offering Memoranda that contains an untrue statement of a material fact or omits to state a material fact necessary to make the statements therein, in light of the circumstances under which they were made, not misleading.

6. The Developer represents and warrants that it has complied with and will continue to comply with Chapter 190.048, Florida Statutes, as amended.

7. As of the date hereof, there has been no material adverse change in the business, properties, assets or financial condition of the Developer which has not been disclosed in the Limited Offering Memoranda.

8. The Developer hereby represents that it owns that the lands in the District that will be subject to the Assessment Area One Special Assessments as described in the Limited Offering Memoranda, and the Developer hereby consents to the levy of the Assessment Area One Special Assessments on the lands in the District owned by the Developer. The levy of the Assessment Area One Special Assessments on the lands in the District will not conflict with or constitute a breach of or default under any agreement, mortgage, lien or other instrument to which either of the Developer is a party or to which their respective properties or assets are subject.

9. The Developer has not made an assignment for the benefit of creditors, filed a petition in bankruptcy, petitioned or applied to any tribunal for the appointment of a custodian, receiver or any trustee or commenced any proceeding under any bankruptcy, reorganization, arrangement, readjustment of debt, dissolution or liquidation law or statute of any jurisdiction. The Developer has not indicated its consent to, or approval of, or failed to object timely to, any petition in bankruptcy, application or proceeding or order for relief or the appointment of a custodian, receiver or any trustee.

10. The Developer acknowledges that the Assessment Area One Bonds have the debt service requirements set forth in the Limited Offering Memorandum and that the Assessment Area One Special Assessments will be levied by the District at times, and in amounts sufficient, to enable the District to pay debt service on the Assessment Area One Bonds when due.

11. To the best of our knowledge, the Developer is not in default under any other resolution, ordinance, agreement or indenture, mortgage, lease, deed of trust, note or other instrument to which the Developer is subject or by which the Developer or its properties are or may be bound, which would have a material adverse effect on the consummation of the transactions contemplated by the Financing Documents, Ancillary Documents, the Declaration of Consent or on the Development and is current in the payment of all ad valorem, federal and state taxes associated with the Development.

12. Except as otherwise disclosed in the Limited Offering Memoranda, there is no action, suit or proceedings at law or in equity by or before any court or public board or body pending or, solely to the best of our knowledge, threatened against the Developer (or any basis therefor) (a) seeking to restrain or enjoin the execution or delivery of Financing Documents, Declaration of Consent and/or Ancillary Documents to which the Developer is a party, (b) contesting or affecting the validity or enforceability of the Financing Documents, Declaration of Consent and/or Ancillary Documents, or any and all such other agreements or documents as may be required to be executed, or the transactions contemplated thereunder, (c) contesting or affecting the establishment or existence of the Developer or of the Developer's business, assets, property or conditions, financial or otherwise, or contesting or affecting any of the powers of the Developer, or (d) that would have a material and adverse effect upon the ability of the Developer to (i) complete the development of lands within the District as described in the Limited Offering Memoranda, (ii) pay the Assessment Area One Special Assessments, or (iii) perform its various obligations as described in the Limited Offering Memoranda.

13. To the best of our knowledge after due inquiry, the Developer is in compliance in all material respects with all provisions of applicable law in all material matters relating to the Development as described in the Limited Offering Memoranda, including applying for all necessary permits. Except as

otherwise described in the Limited Offering Memoranda, (a) the District is zoned and properly designated for its intended use; (b) all government permits other than certain permits, which permits are expected to be received as needed, have been received; (c) the Developer is not aware of any default of any zoning condition, permit or development agreement which would adversely affect the Developer's ability to complete or cause the completion of the Assessment Area One Project or the development of Assessment Area One as described in the Limited Offering Memoranda and all appendices thereto; and (d) there is no reason to believe that any permits, consents and licenses required to complete the Assessment Area One Project or the development of Assessment Area One as described in the Offering Memoranda will not be obtained as required.

14. The Developer acknowledges that it will have no rights under Chapter 170, Florida Statutes, as amended, to prepay, without interest, the Assessment Area One Special Assessments imposed on lands in the District owned by the Developer within thirty (30) days following completion of the Assessment Area One Project and acceptance thereof by the District.

15. The Developer has entered into prior continuing disclosure obligations in connection with SEC Rule 15c2-12, and the information presented in the Limited Offering Memoranda under the heading "CONTINUING DISCLOSURE" (at it relates to the Developer only) accurately reflects the continuing disclosure history of the Developer.

16. The Developer is not in default of any obligations to pay special assessments, and the Developer is not insolvent.

Dated: [_____], 2023.

CLAYTON PROPERTIES GROUP, INC., a
Tennessee corporation

By: _____
_____, its Manager

EXHIBIT G

CERTIFICATE OF ENGINEER

CERTIFICATE OF DEWBERRY ENGINEERS INC. (the "Engineers"), DOES HEREBY CERTIFY, that:

1. This certificate is furnished pursuant to Section 8(c)(17) of the Bond Purchase Contract dated [____], 2023 (the "Purchase Contract"), by and between Hickory Tree Community Development District (the "District") and FMSbonds, Inc. with respect to the District's \$[____] original aggregate principal amount of Hickory Tree Community Development District Special Assessment Bonds, Series 2023 (Assessment Area One Project) (the "Assessment Area One Bonds"). Capitalized terms used, but not defined, herein shall have the meaning assigned thereto in the Purchase Contract or the Preliminary Limited Offering Memorandum dated [____], 2023 and the Limited Offering Memorandum, dated [____], 2023, including the appendices attached thereto, relating to the Assessment Area One Bonds (collectively, the "Limited Offering Memoranda"), as applicable.

2. The Engineers have been retained by the District as consulting engineers.

3. The plans and specifications for the Assessment Area One Project (as described in the Limited Offering Memoranda) were approved by all regulatory bodies required to approve them. All environmental and other regulatory permits or approvals required in connection with the construction of the Assessment Area One were obtained or are expected to be obtained in the ordinary course.

4. The Engineers prepared the report entitled "Hickory Tree Community Development District Engineer's Report" dated June 28, 2022, as supplemented by the "[____]" dated [____], 2023] (the "Report"). The Report was prepared in accordance with generally accepted engineering principles. The Report is included as "APPENDIX A: ENGINEER'S REPORT" to the Preliminary Limited Offering Memorandum and the Limited Offering Memorandum and a description of the Report and certain other information relating to the Assessment Area One Project are included in the Preliminary Limited Offering Memorandum and the Limited Offering Memorandum under the captions "THE CAPITAL IMPROVEMENT PLAN AND THE ASSESSMENT AREA ONE PROJECT" and "THE DEVELOPMENT." The Report and said information are true and complete in all material respects, contain no untrue statement of a material fact, and do not omit to state a material fact necessary to make the statements made therein, in light of the circumstances under which they were made, not misleading.

5. The Engineers hereby consent to the inclusion of the Report as "APPENDIX A: ENGINEER'S REPORT" to the Preliminary Limited Offering Memorandum and the Limited Offering Memorandum and to the references to the Engineers in the Preliminary Limited Offering Memorandum and the Limited Offering Memorandum.

6. The Assessment Area One Project is being constructed in sound workmanlike manner and in accordance with industry standards.

7. The price being paid by the District to the District for acquisition of the improvements included within the Assessment Area One Project will not exceed the lesser of the cost of the Assessment Area One Project or the fair market value of the assets acquired by the District.

8. To the best of our knowledge, after due inquiry, the Developer is in compliance in all material respects with all provisions of applicable law in all material matters relating to the Developer, the

Assessment Area One Project and the development of Assessment Area One as described in the Limited Offering Memoranda. Except as otherwise described in the Limited Offering Memoranda, (a) all government permits required in connection with the construction of the Assessment Area One Project and the development of Assessment Area One, as described in the Limited Offering Memoranda, have been received or are expected to be received in the ordinary course; (b) we are not aware of any default of any zoning condition, land use permit or development agreement which would adversely affect the ability to complete the Assessment Area One Project or the development of Assessment Area One as described in the Limited Offering Memoranda and all appendices thereto; and (c) we have no actual knowledge and are not otherwise aware of any reason to believe that any permits, consents and licenses required to complete the Assessment Area One Project and the development of Assessment Area One as described in the Limited Offering Memoranda and all appendices thereto will not be obtained in due course as required by the Developer, or any other person or entity.

9. There is adequate water and sewer service capacity to serve Assessment Area One.

Date: [_____], 2023

DEWBERRY ENGINEERS INC.

By: _____
Print Name: _____
Title: _____

EXHIBIT H

CERTIFICATE OF DISTRICT MANAGER AND METHODOLOGY CONSULTANT

[_____], 2023

Hickory Tree Community Development District
Osceola County, Florida

FMSbonds, Inc.
North Miami Beach, Florida

Re: \$[_____] Hickory Tree Community Development District Special Assessment Bonds,
 Series 2023 (Assessment Area One Project)

Ladies and Gentlemen:

The undersigned representative of Governmental Management Services – Central Florida, LLC ("GMS"), DOES HEREBY CERTIFY:

1. This certificate is furnished pursuant to Section 8(c)(18) and (29) of the Bond Purchase Contract dated [_____] , 2023 (the "Purchase Contract"), by and between Hickory Tree Community Development District (the "District") and FMSbonds, Inc. with respect to the District's \$[_____] original aggregate principal amount of Hickory Tree Community Development District Special Assessment Bonds, Series 2023 (Assessment Area One Project) (the "Assessment Area One Bonds"). Capitalized terms used, but not defined, herein shall have the meaning assigned thereto in the Purchase Contract or the Limited Offering Memoranda relating to the Assessment Area One Bonds, as applicable.

2. GMS has acted as district manager and methodology consultant to the District in connection with the sale and issuance by the District of its Assessment Area One Bonds and has participated in the preparation of the Preliminary Limited Offering Memorandum dated [_____] , 2023 and the Limited Offering Memorandum, dated [_____] , 2023, including the appendices attached thereto (collectively, the "Limited Offering Memoranda").

3. In connection with the issuance of the Assessment Area One Bonds, we have been retained by the District to prepare the Master Assessment Methodology for Hickory Tree Community Development District dated June 28, 2022, as supplemented by the First Supplemental Assessment Methodology (2023 Project) for Hickory Tree Community Development District dated [_____] , 2023 (collectively, the "Assessment Methodology"), which Assessment Methodology has been included as an appendix to the Limited Offering Memoranda. We hereby consent to the use of the Assessment Methodology in the Limited Offering Memoranda and consent to the references to us therein.

4. As District Manager, nothing has come to our attention that would lead us to believe that the Limited Offering Memoranda, as they relate to the District, the Assessment Area One Project, or any information provided by us, and the Assessment Methodology, as of their respective dates and as of this date, contained or contains any untrue statement of a material fact or omitted or omits to state a material fact necessary to be stated therein in order to make the statements made therein, in light of the circumstances under which they were made, not misleading.

5. The information set forth in the Limited Offering Memoranda under the subcaptions "ASSESSMENT METHODOLOGY AND THE ALLOCATION OF ASSESSMENTS," "THE DISTRICT," "FINANCIAL STATEMENTS," "LITIGATION" (insofar as such description relates to the District), "DISCLOSURE REQUIRED BY FLORIDA BLUE SKY REGULATIONS," "CONTINUING DISCLOSURE," "CONTINGENT FEES," and in "APPENDIX D: ASSESSMENT METHODOLOGY" did not as of the respective dates of the Limited Offering Memoranda and does not as of the date hereof contain any untrue statement of a material fact or omit to state a material fact necessary to make the statements therein, in the light of the circumstances under which they were made, not misleading.

6. To the best of our knowledge, there has been no change which would materially adversely affect the assumptions made or the conclusions reached in the Assessment Methodology, and the considerations and assumptions used in compiling the Assessment Methodology are reasonable. The Assessment Methodology and the assessment methodology set forth therein were prepared in accordance with all applicable provisions of Florida law.

7. As District Manager for the District, we are not aware of any litigation pending or, to the best of our knowledge, threatened against the District restraining or enjoining the issuance, sale, execution or delivery of the Assessment Area One Bonds, or in any way contesting or affecting the validity of the Assessment Area One Bonds or any proceedings of the District taken with respect to the issuance or sale thereof, or the pledge or application of any moneys or security provided for the payment of the Assessment Area One Bonds, or the existence or powers of the District.

8. The Assessment Area One Special Assessments, as initially levied and as may be reallocated from time to time as permitted by resolutions adopted by the District, are sufficient to enable the District to pay the debt service on the Assessment Area One Bonds through the final maturity thereof.

9. GMS hereby acknowledges its agreement to serve as the Dissemination Agent for the District for the Assessment Area One Bonds and undertake the obligations of the Dissemination Agent as set forth in the Continuing Disclosure Agreement dated [_____], 2023 (the "Disclosure Agreement") by and among the District, Clayton Properties Group, Inc., and GMS, as Dissemination Agent, and acknowledged by GMS, as District Manager, and U.S. Bank Trust Company, National Association, as trustee. GMS hereby represents that it is aware of the continuing disclosure requirements set forth in the Disclosure Agreement and Rule 15c2-12 promulgated under the Securities Act of 1933, as amended, that it has policies and procedures in place to ensure its compliance with its obligations under the Disclosure Agreement, and that it will comply with its obligations under the Disclosure Agreement.

Dated: [_____], 2023.

**GOVERNMENTAL MANAGEMENT
SERVICES – CENTRAL FLORIDA, LLC**, a
Florida limited liability company

By: _____
Name: _____
Title: _____

EXHIBIT C

FORM OF PRELIMINARY LIMITED OFFERING MEMORANDUM

PRELIMINARY LIMITED OFFERING MEMORANDUM DATED [_____] 2023

**NEW ISSUES - BOOK-ENTRY-ONLY
LIMITED OFFERING**

NOT RATED

In the opinion of Greenberg Traurig, P.A., Bond Counsel, assuming the accuracy of certain representations and certifications and the continuing compliance with certain tax covenants, under existing statutes, regulations, rulings and court decisions, interest on the Assessment Area One Bonds (as hereinafter defined) is excludable from gross income for federal income tax purposes; and, further, interest on the Assessment Area One Bonds will not be an item of tax preference for purposes of the alternative minimum tax imposed on individuals. In the case of the alternative minimum tax imposed by Section 55(b)(2) of the Internal Revenue Code of 1986, as amended (the "Code") on applicable corporations (as defined in Section 59(k) of the Code), interest on the Assessment Area One Bonds is not excluded from the determination of adjusted financial statement income. See "TAX MATTERS" herein for a description of certain other federal tax consequences of ownership of the Assessment Area One Bonds. Bond Counsel is further of the opinion that the Assessment Area One Bonds and the interest thereon are not subject to taxation under the laws of the State of Florida, except as to estate taxes and taxes under Chapter 220, Florida Statutes, on interest, income or profits on debt obligations owned by corporations as defined in said Chapter 220. See "TAX MATTERS" herein.

**HICKORY TREE COMMUNITY DEVELOPMENT DISTRICT
(OSCEOLA COUNTY, FLORIDA)**

**[\$14,860,000]*
SPECIAL ASSESSMENT BONDS, SERIES 2023
(ASSESSMENT AREA ONE PROJECT)**

Dated: Date of Delivery

Due: As described herein

The Hickory Tree Community Development District Special Assessment Bonds, Series 2023 (Assessment Area One Project) (the "Assessment Area One Bonds") are being issued by the Hickory Tree Community Development District (the "District" or the "Issuer") in fully registered form, without coupons, in authorized denominations of \$5,000 and any integral multiple thereof. The Assessment Area One Bonds will bear interest at the fixed rates set forth in the inside cover page hereof, calculated on the basis of a 360-day year comprised of twelve 30-day months, payable semi-annually on each May 1 and November 1, commencing [May 1, 2024]. The Assessment Area One Bonds, when issued, will be registered in the name of Cede & Co., as nominee for The Depository Trust Company ("DTC"), New York, New York. Purchases of beneficial interests in the Assessment Area One Bonds will be made in book-entry-only form and purchasers of beneficial interests in the Assessment Area One Bonds will not receive physical bond certificates. For so long as the book-entry only system is maintained, the principal of and interest on the Assessment Area One Bonds will be paid from the sources provided by the Indenture (as defined herein) by U.S. Bank Trust Company, National Association, as trustee (the "Trustee"), directly to Cede & Co., as the registered owner thereof. Disbursement of such payments to the Direct Participants is the responsibility of DTC and disbursement of such payments to the beneficial owners is the responsibility of the Direct Participants and Indirect Participants, as more fully described herein. Any purchaser, as a beneficial owner of an Assessment Area One Bond, must maintain an account with a broker or dealer who is, or acts through, a Direct Participant in order to receive payment of the principal of, premium, if any, and interest on such Assessment Area One Bond. See "DESCRIPTION OF THE ASSESSMENT AREA ONE BONDS – Book-Entry Only System" herein.

The Assessment Area One Bonds are being issued for the purposes of: (i) providing funds to pay all or a portion of the costs of the planning, financing, acquisition, construction, equipping and installation of the Assessment Area One Project (as defined herein), (ii) funding a deposit to the Assessment Area One Reserve Account in the amount of the Assessment Area One Reserve Requirement (each as defined herein), (iii) paying a portion of the interest coming due on the Assessment Area One Bonds and (iv) paying the costs of issuance of the Assessment Area One Bonds. See "ESTIMATED SOURCES AND USES OF FUNDS" herein.

The District is a local unit of special-purpose government of the State of Florida (the "State"), created in accordance with the Uniform Community Development District Act of 1980, Chapter 190, Florida Statutes, as amended (the "Act"), and by Ordinance No. 2022-60 enacted by the Board of County Commissioners of Osceola County, Florida (the "County") on June 27, 2022, which became effective on June 29, 2022 (the "Ordinance"). The Assessment Area One Bonds are being issued pursuant to the Act, Resolution No. 2022-26 and Resolution No. 2023-[07] adopted by the Board of Supervisors (the "Board") of the District on July 14, 2022 and [September 6], 2023 (collectively, the "Resolution"), and a Master Trust Indenture dated as of [_____] 1, 2023 (the "Master Indenture"), as supplemented by a First Supplemental Trust Indenture, dated as of [_____] 1, 2023 (the "First Supplemental Indenture" and, together with the Master Indenture, the "Indenture"), each by and between the District and the Trustee. Capitalized terms not otherwise defined herein shall have the meanings assigned to them in the Indenture. See "APPENDIX B: PROPOSED FORMS OF MASTER INDENTURE AND FIRST SUPPLEMENTAL INDENTURE" hereto.

The Assessment Area One Bonds are payable from and secured solely by the Assessment Area One Pledged Revenues. The Assessment Area One Pledged Revenues for the Assessment Area One Bonds consist of (a) all revenues received by the District from the Assessment Area One Special Assessments levied and collected from Assessment Area One (as defined herein), including without limitation, amounts received from any foreclosure proceeding for the enforcement of collection of such Assessment Area One Special Assessments or from the issuance and sale of tax certificates with respect to such Assessment Area One Special Assessments, and (b) all moneys on deposit in the Funds and Accounts established under the Indenture, created and established with respect to or for the benefit of the Assessment Area One Bonds; provided, however, that the Assessment Area One Pledged Revenues shall not include (A) any moneys transferred to the Assessment Area One Rebate Fund and investment earnings thereon, (B) moneys on deposit in the Assessment Area One Costs of Issuance Account of the Acquisition and Construction Fund and (C) "special assessments" levied and collected by the District under Section 190.022, of the Act, for maintenance purposes or "maintenance assessments" levied and collected by the District under Section 190.021(3) of the Act (it being expressly understood that the lien and pledge of the

This Preliminary Limited Offering Memorandum and the information contained herein are subject to completion or amendment. Under no circumstances shall this Preliminary Limited Offering Memorandum constitute an offer to sell or a solicitation of an offer to buy, nor shall there be any sale of the Assessment Area One Bonds in any jurisdiction in which such offer, solicitation or sale would be unlawful prior to registration, qualification or exemption under the securities laws of such jurisdiction. The District has deemed this Preliminary Limited Offering Memorandum "final," except for permitted omissions, within the contemplation of Rule 15c2-12 promulgated by the Securities and Exchange Commission.

Indenture shall not apply to any of the moneys described in the foregoing clauses of (A), (B) and (C) of this proviso). See "SECURITY FOR AND SOURCE OF PAYMENT OF THE ASSESSMENT AREA ONE BONDS" herein.

The Assessment Area One Bonds are subject to optional redemption, mandatory sinking fund redemption and extraordinary mandatory redemption at the times, in the amounts, and at the redemption prices more fully described herein under the caption "DESCRIPTION OF THE ASSESSMENT AREA ONE BONDS – Redemption Provisions" herein.

THE ASSESSMENT AREA ONE BONDS ARE LIMITED OBLIGATIONS OF THE DISTRICT PAYABLE SOLELY FROM THE ASSESSMENT AREA ONE PLEDGED REVENUES PLEDGED THEREFOR UNDER THE INDENTURE, AND NEITHER THE PROPERTY, THE FULL FAITH AND CREDIT, NOR THE TAXING POWER OF THE DISTRICT, THE COUNTY, THE STATE OF FLORIDA (THE "STATE"), OR ANY OTHER POLITICAL SUBDIVISION THEREOF, IS PLEDGED AS SECURITY FOR THE PAYMENT OF THE ASSESSMENT AREA ONE BONDS, EXCEPT THAT THE DISTRICT IS OBLIGATED UNDER THE INDENTURE TO LEVY AND TO EVIDENCE AND CERTIFY, OR CAUSE TO BE CERTIFIED, FOR COLLECTION ASSESSMENT AREA ONE SPECIAL ASSESSMENTS TO SECURE AND PAY THE ASSESSMENT AREA ONE BONDS. THE ASSESSMENT AREA ONE BONDS DO NOT CONSTITUTE AN INDEBTEDNESS OF THE DISTRICT, THE COUNTY, THE STATE, OR ANY OTHER POLITICAL SUBDIVISION THEREOF WITHIN THE MEANING OF ANY CONSTITUTIONAL OR STATUTORY PROVISION OR LIMITATION.

The Assessment Area One Bonds involve a degree of risk (see "BONDOWNERS' RISKS" herein) and are not suitable for all investors (see "SUITABILITY FOR INVESTMENT" herein). Pursuant to Florida law, the Underwriter (as defined herein) is limiting this offering to "accredited investors" within the meaning of Chapter 517, Florida Statutes, and the rules of the Florida Department of Financial Services promulgated thereunder. The limitation of the initial offering to accredited investors does not denote restrictions on transfers in any secondary market for the Assessment Area One Bonds. The Assessment Area One Bonds are not credit enhanced or rated and no application has been made for a rating with respect to the Assessment Area One Bonds.

This cover page contains certain information for quick reference only. It is not a summary of the Assessment Area One Bonds. Investors must read this entire Limited Offering Memorandum to obtain information essential to the making of an informed investment decision.

MATURITY SCHEDULE

\$ _____	- _____%	Term Bond due _____	1, 20__	, Yield _____%	, Price _____	CUSIP # _____	**
\$ _____	- _____%	Term Bond due _____	1, 20__	, Yield _____%	, Price _____	CUSIP # _____	**
\$ _____	- _____%	Term Bond due _____	1, 20__	, Yield _____%	, Price _____	CUSIP # _____	**
\$ _____	- _____%	Term Bond due _____	1, 20__	, Yield _____%	, Price _____	CUSIP # _____	**

The Assessment Area One Bonds are offered for delivery when, as and if issued by the District and accepted by the Underwriter, subject to the receipt of the opinion of Greenberg Traurig, P.A., Miami, Florida, Bond Counsel, as to the validity of the Assessment Area One Bonds and the excludability of interest thereon from gross income for federal income tax purposes. Certain legal matters will be passed upon for the Underwriter by its counsel, GrayRobinson, P.A., Tampa, Florida, for the District by its counsel, Kilinski | Van Wyk PLLC, Tallahassee, Florida, and for the Developer (as defined herein) by its counsel, Johnson Pope Bokor Ruppel & Burns, LLP, Tampa, Florida. It is expected that the Assessment Area One Bonds will be delivered in book-entry form through the facilities of DTC on or about _____, 2023.

FMSbonds, Inc.

Dated: _____, 2023

* Preliminary, subject to change.

** The District is not responsible for the use of CUSIP numbers, nor is any representation made as to their correctness. They are included solely for the convenience of the readers of this Limited Offering Memorandum.

HICKORY TREE COMMUNITY DEVELOPMENT DISTRICT

BOARD OF SUPERVISORS

Milton Andrade, Chair*
Brian Walsh, Vice Chair*
Joel Adams, Assistant Secretary*
Garret Parkinson, Assistant Secretary*
Jeffrey Shenefield, Assistant Secretary*

* Affiliated with the Developer or its affiliates

DISTRICT MANAGER AND METHODOLOGY CONSULTANT

Governmental Management Services – Central Florida, LLC
Orlando, Florida

DISTRICT ENGINEER

Dewberry Engineers Inc.
Orlando, Florida

DISTRICT COUNSEL

Kilinski | Van Wyk PLLC
Tallahassee, Florida

BOND COUNSEL

Greenberg Traurig, P.A.
Miami, Florida

NO DEALER, BROKER, SALESPERSON OR OTHER PERSON HAS BEEN AUTHORIZED BY THE DISTRICT TO GIVE ANY INFORMATION OR TO MAKE ANY REPRESENTATIONS, OTHER THAN THOSE CONTAINED IN THIS LIMITED OFFERING MEMORANDUM, AND IF GIVEN OR MADE, SUCH OTHER INFORMATION OR REPRESENTATIONS MUST NOT BE RELIED UPON AS HAVING BEEN AUTHORIZED BY THE DISTRICT. THIS LIMITED OFFERING MEMORANDUM DOES NOT CONSTITUTE AN OFFER TO SELL OR THE SOLICITATION OF AN OFFER TO BUY ANY OF THE ASSESSMENT AREA ONE BONDS AND THERE SHALL BE NO OFFER, SOLICITATION, OR SALE OF THE ASSESSMENT AREA ONE BONDS BY ANY PERSON IN ANY JURISDICTION IN WHICH IT IS UNLAWFUL FOR SUCH PERSON TO MAKE SUCH OFFER, SOLICITATION OR SALE.

THE INFORMATION SET FORTH HEREIN HAS BEEN OBTAINED FROM THE DEVELOPER (AS HEREINAFTER DEFINED), THE DISTRICT, PUBLIC DOCUMENTS, RECORDS AND OTHER SOURCES, WHICH SOURCES ARE BELIEVED TO BE RELIABLE BUT WHICH INFORMATION IS NOT GUARANTEED AS TO ACCURACY OR COMPLETENESS BY, AND IS NOT TO BE CONSTRUED AS A REPRESENTATION OF, THE UNDERWRITER NAMED ON THE COVER PAGE OF THIS LIMITED OFFERING MEMORANDUM. THE UNDERWRITER HAS REVIEWED THE INFORMATION IN THIS LIMITED OFFERING MEMORANDUM IN ACCORDANCE WITH, AND AS PART OF, ITS RESPONSIBILITIES TO INVESTORS UNDER THE FEDERAL SECURITIES LAWS AS APPLIED TO THE FACTS AND CIRCUMSTANCES OF THIS TRANSACTION, BUT THE UNDERWRITER DOES NOT GUARANTEE THE ACCURACY OR COMPLETENESS OF SUCH INFORMATION. THE INFORMATION AND EXPRESSIONS OF OPINION HEREIN CONTAINED ARE SUBJECT TO CHANGE WITHOUT NOTICE AND NEITHER THE DELIVERY OF THIS LIMITED OFFERING MEMORANDUM, NOR ANY SALE MADE HEREUNDER, SHALL, UNDER ANY CIRCUMSTANCES, CREATE ANY IMPLICATION THAT THERE HAS BEEN NO CHANGE IN THE AFFAIRS OF THE DISTRICT OR THE DEVELOPER OR IN THE STATUS OF THE DEVELOPMENT, ASSESSMENT AREA ONE OR THE ASSESSMENT AREA ONE PROJECT (AS SUCH TERMS ARE HEREINAFTER DEFINED) SINCE THE DATE HEREOF.

THE ASSESSMENT AREA ONE BONDS HAVE NOT BEEN REGISTERED WITH THE SECURITIES AND EXCHANGE COMMISSION UNDER THE SECURITIES ACT OF 1933, AS AMENDED, NOR HAS THE INDENTURE BEEN QUALIFIED UNDER THE TRUST INDENTURE ACT OF 1939, AS AMENDED, IN RELIANCE UPON CERTAIN EXEMPTIONS SET FORTH IN SUCH ACTS. THE REGISTRATION, QUALIFICATION OR EXEMPTION OF THE ASSESSMENT AREA ONE BONDS IN ACCORDANCE WITH THE APPLICABLE SECURITIES LAW PROVISIONS OF ANY JURISDICTIONS WHEREIN THESE SECURITIES HAVE BEEN OR WILL BE REGISTERED, QUALIFIED OR EXEMPTED SHOULD NOT BE REGARDED AS A RECOMMENDATION THEREOF. NEITHER THE DISTRICT, THE COUNTY, THE STATE, NOR ANY OTHER POLITICAL SUBDIVISIONS THEREOF HAVE GUARANTEED OR PASSED UPON THE MERITS OF THE ASSESSMENT AREA ONE BONDS, UPON THE PROBABILITY OF ANY EARNINGS THEREON OR UPON THE ACCURACY OR ADEQUACY OF THIS LIMITED OFFERING MEMORANDUM.

"FORWARD-LOOKING STATEMENTS" ARE USED IN THIS DOCUMENT BY USING FORWARD LOOKING WORDS SUCH AS "MAY," "WILL," "SHOULD," "INTENDS," "EXPECTS," "BELIEVES," "ANTICIPATES," "ESTIMATES," OR OTHERS. THE READER IS CAUTIONED THAT FORWARD-LOOKING STATEMENTS ARE SUBJECT TO A VARIETY OF UNCERTAINTIES THAT COULD CAUSE ACTUAL RESULTS TO DIFFER FROM THE PROJECTED RESULTS. THOSE RISKS AND UNCERTAINTIES INCLUDE GENERAL ECONOMIC AND BUSINESS CONDITIONS, CONDITIONS IN THE FINANCIAL MARKETS AND REAL ESTATE MARKET, THE DISTRICT'S COLLECTION OF THE ASSESSMENT AREA ONE SPECIAL ASSESSMENTS, AND

VARIOUS OTHER FACTORS WHICH MAY BE BEYOND THE DISTRICT'S AND THE DEVELOPER CONTROL. BECAUSE THE DISTRICT AND THE DEVELOPER CANNOT PREDICT ALL FACTORS THAT MAY AFFECT FUTURE DECISIONS, ACTIONS, EVENTS, OR FINANCIAL CIRCUMSTANCES, WHAT ACTUALLY HAPPENS MAY BE DIFFERENT FROM WHAT IS INCLUDED IN FORWARD-LOOKING STATEMENTS.

THE ACHIEVEMENT OF CERTAIN RESULTS OR OTHER EXPECTATIONS CONTAINED IN SUCH FORWARD-LOOKING STATEMENTS INVOLVE KNOWN AND UNKNOWN RISKS, UNCERTAINTIES AND OTHER FACTORS WHICH MAY CAUSE ACTUAL RESULTS, PERFORMANCE OR ACHIEVEMENTS DESCRIBED TO BE MATERIALLY DIFFERENT FROM ANY FUTURE RESULTS, PERFORMANCE OR ACHIEVEMENTS EXPRESSED OR IMPLIED BY SUCH FORWARD-LOOKING STATEMENTS. THE DISTRICT AND THE DEVELOPER DO NOT PLAN TO ISSUE ANY UPDATES OR REVISIONS TO THOSE FORWARD-LOOKING STATEMENTS IF OR WHEN ANY OF THEIR EXPECTATIONS CHANGE OR EVENTS, CONDITIONS OR CIRCUMSTANCES ON WHICH SUCH STATEMENTS ARE BASED OCCUR, OTHER THAN AS DESCRIBED UNDER "CONTINUING DISCLOSURE" HEREIN.

THIS LIMITED OFFERING MEMORANDUM IS BEING PROVIDED TO PROSPECTIVE PURCHASERS ONLY IN ELECTRONIC FORMAT ON THE FOLLOWING WEBSITES: WWW.MUNIOS.COM AND WWW.EMMA.MSRB.ORG. THIS LIMITED OFFERING MEMORANDUM MAY BE RELIED UPON ONLY IF IT IS PRINTED IN ITS ENTIRETY DIRECTLY FROM SUCH WEBSITE.

THIS PRELIMINARY LIMITED OFFERING MEMORANDUM IS IN A FORM DEEMED FINAL BY THE DISTRICT FOR PURPOSES OF RULE 15C2-12 UNDER THE SECURITIES EXCHANGE ACT OF 1934, AS AMENDED, EXCEPT FOR CERTAIN INFORMATION PERMITTED TO BE OMITTED PURSUANT TO RULE 15C2-12(B)(1).

TABLE OF CONTENTS

	Page
INTRODUCTION	1
DESCRIPTION OF THE ASSESSMENT AREA ONE BONDS	3
General Description	3
Redemption Provisions	4
Book-Entry Only System	7
SECURITY FOR AND SOURCE OF PAYMENT OF THE ASSESSMENT AREA ONE BONDS	9
General	9
Prepayment of Assessment Area One Special Assessments	10
Additional Bonds	11
Covenant Against Sale or Encumbrance	11
Acquisition and Construction Account	12
Assessment Area One Reserve Account	13
Deposit and Application of the Pledged Revenues	15
Investments	16
Master Indenture Provisions Relating to Bankruptcy or Insolvency of a Landowner	16
Events of Default and Remedies	18
ENFORCEMENT OF ASSESSMENT COLLECTIONS	19
General	19
Direct Billing & Foreclosure Procedure	20
Uniform Method Procedure	21
BONDOWNERS' RISKS	23
Concentration of Land Ownership	24
Bankruptcy and Related Risks	24
Assessment Area One Special Assessments Are Non-Recourse	25
Regulatory and Environmental Risks	25
Economic Conditions and Changes in Development Plans	26
Other Taxes and Assessments	26
Limited Secondary Market for Assessment Area One Bonds	27
Inadequacy of Reserve Account	27
Legal Delays	27
IRS Examination and Audit Risk	27
Loss of Exemption from Securities Registration	29
Federal Tax Reform	30
State Tax Reform	30
Insufficient Resources or Other Factors Causing Failure to Complete Development	30
Pandemics and Other Public Health Emergencies	31
Cybersecurity	31
Prepayment and Redemption Risk	31
Payment of Assessment Area One Special Assessments after Bank Foreclosure	31
ESTIMATED SOURCES AND USES OF FUNDS	33
DEBT SERVICE REQUIREMENTS	34

TABLE OF CONTENTS
(continued)

	Page
THE DISTRICT	35
General.....	35
Governance.....	35
Legal Powers and Authority	36
The District Manager and Other Consultants	37
No Outstanding Bond Indebtedness	37
THE CAPITAL IMPROVEMENT PLAN AND THE ASSESSMENT AREA ONE PROJECT	38
ASSESSMENT METHODOLOGY AND THE ALLOCATION OF ASSESSMENTS.....	40
THE DEVELOPMENT	42
General Overview.....	42
Land Acquisition and Finance Plan.....	43
Development Plan and Status	44
Residential Product Offerings	44
Development Approvals	44
Environmental	44
Amenities.....	45
Utilities	45
Taxes, Fees and Assessments	45
Education	46
Competition	46
Developer Agreements	46
THE DEVELOPER	47
TAX MATTERS	48
General.....	48
Original Issue Discount and Premium.....	49
Changes in Federal and State Tax Law	50
Information Reporting and Backup Withholding.....	50
AGREEMENT BY THE STATE.....	50
LEGALITY FOR INVESTMENT	51
SUITABILITY FOR INVESTMENT	51
ENFORCEABILITY OF REMEDIES	51
FINANCIAL STATEMENTS.....	51
LITIGATION	52
The District	52
The Developer	52
NO RATING	52
DISCLOSURE REQUIRED BY FLORIDA BLUE SKY REGULATIONS	52
CONTINUING DISCLOSURE.....	52
UNDERWRITING	53

TABLE OF CONTENTS
(continued)

	Page
CONTINGENT FEES	53
EXPERTS	53
VALIDATION	53
LEGAL MATTERS.....	54
MISCELLANEOUS	54
AUTHORIZATION AND APPROVAL.....	55
 <u>APPENDICES</u>	
APPENDIX A	ENGINEER'S REPORT
APPENDIX B	PROPOSED FORMS OF MASTER INDENTURE AND FIRST SUPPLEMENTAL INDENTURE
APPENDIX C	PROPOSED FORM OF OPINION OF BOND COUNSEL
APPENDIX D	ASSESSMENT METHODOLOGY
APPENDIX E	PROPOSED FORM OF CONTINUING DISCLOSURE AGREEMENT
APPENDIX F	DISTRICT'S FINANCIAL STATEMENTS

LIMITED OFFERING MEMORANDUM

**HICKORY TREE COMMUNITY DEVELOPMENT DISTRICT
(OSCEOLA COUNTY, FLORIDA)**

**[\$14,860,000]*
SPECIAL ASSESSMENT BONDS, SERIES 2023
(ASSESSMENT AREA ONE PROJECT)**

INTRODUCTION

The purpose of this Limited Offering Memorandum, including the cover page, inside cover and appendices hereto, is to provide certain information in connection with the issuance and sale by Hickory Tree Community Development District (the "District" or the "Issuer") of its \$[14,860,000]* aggregate principal amount of Special Assessment Bonds, Series 2023 (Assessment Area One Project) (the "Assessment Area One Bonds").

PROSPECTIVE INVESTORS SHOULD BE AWARE OF CERTAIN RISK FACTORS, ANY OF WHICH, IF MATERIALIZED TO A SUFFICIENT DEGREE, COULD DELAY OR PREVENT PAYMENT OF PRINCIPAL OF AND/OR INTEREST ON THE ASSESSMENT AREA ONE BONDS. THE ASSESSMENT AREA ONE BONDS ARE NOT A SUITABLE INVESTMENT FOR ALL INVESTORS. PURSUANT TO APPLICABLE STATE LAW, THE UNDERWRITER IS LIMITING THIS INITIAL OFFERING OF THE ASSESSMENT AREA ONE BONDS TO ONLY ACCREDITED INVESTORS WITHIN THE MEANING OF CHAPTER 517, FLORIDA STATUTES, AND THE RULES OF THE FLORIDA DEPARTMENT OF FINANCIAL SERVICES PROMULGATED THEREUNDER. THE LIMITATION OF THE INITIAL OFFERING TO ACCREDITED INVESTORS DOES NOT DENOTE RESTRICTIONS ON TRANSFERS IN ANY SECONDARY MARKET FOR THE ASSESSMENT AREA ONE BONDS. SEE "SUITABILITY FOR INVESTMENT" AND "BONDOWNERS' RISKS" HEREIN.

The District is a local unit of special-purpose government of the State of Florida (the "State"), created in accordance with the Uniform Community Development District Act of 1980, Chapter 190, Florida Statutes, as amended (the "Act"), and by Ordinance No. 2022-60 duly enacted by the Board of County Commissioners of Osceola County, Florida (the "County") on June 27, 2022, which became effective on June 29, 2022 (the "Ordinance"). The District was created for the purpose of delivering certain community development services and facilities for the benefit of District Lands (as hereinafter defined) and has previously determined to undertake, in one or more stages, the acquisition and/or construction of public improvements and community facilities as set forth in the Act for the special benefit of the District Lands. The Act authorizes the District to issue bonds for the purposes of, among others, financing, funding, planning, establishing, acquiring, constructing or reconstructing, enlarging or extending, or equipping water management, water supply, sewer and wastewater management, bridges or culverts, public roads, street lights and other basic infrastructure projects within or without the boundaries of the District as provided in the Act.

The District encompasses approximately 205 gross acres of land (the "District Lands"), located within an unincorporated portion of the County. The Development is located east of Lake Gentry Road, south of Hickory Tree Road, and west of Brick Lake, approximately five miles east of the Florida Turnpike.

* Preliminary, subject to change.

For more complete information about the District, its Board of Supervisors and the District Manager, see "THE DISTRICT" herein.

The District Lands are being developed as a residential community known as "[Hickory Tree]" (the "Development"). At buildout, the Development is planned to contain 797 residential units, comprising townhome units and single-family homes, together with recreation and amenity areas, parks, and associated infrastructure. See "THE DEVELOPMENT" herein for more information.

The Development is being developed in phases. The first phase of development corresponds to Phases 1 and 2A and contains approximately [91.94] acres of land planned for 406 lots ("Assessment Area One"). The Assessment Area One Bonds will finance a portion of the public infrastructure improvements associated with the development of Assessment Area One (the "Assessment Area One Project"). The public infrastructure associated with the development of the remaining 391 lots planned for the Development will be financed in the future. See "THE CAPITAL IMPROVEMENT PLAN AND THE ASSESSMENT AREA ONE PROJECT" herein for more information.

The Assessment Area One Bonds will be secured by the Assessment Area One Special Assessments (as defined herein), which will initially be levied on the [91.94] acres of land within Assessment Area One. As lots are platted therein, the Assessment Area One Special Assessments will be assigned to platted lots on a first-platted, first-assigned basis as set forth in the Assessment Methodology attached hereto. See "ASSESSMENT METHODOLOGY AND THE ALLOCATION OF ASSESSMENTS" herein and "APPENDIX D: ASSESSMENT METHODOLOGY" hereto for more information regarding the Assessment Area One Special Assessments.

It is anticipated that the District will issue one or more additional series of bonds to finance the remaining public infrastructure improvements for the District. See "SECURITY FOR AND SOURCE OF PAYMENT OF THE ASSESSMENT AREA ONE BONDS – Additional Bonds" herein for more information.

Clayton Properties Group, Inc., a Tennessee corporation doing business as Highland Homes and a wholly owned subsidiary of Berkshire Hathaway (the "Developer"), is the developer and primary homebuilder for the Development. See "THE DEVELOPER" herein for more information.

The Assessment Area One Bonds are being issued pursuant to the Act, Resolution No. 2022-26 and Resolution No. 2023-[07] adopted by the Board of Supervisors (the "Board") of the District on July 14, 2022 and [September 6], 2023 (collectively, the "Resolution"), and a Master Trust Indenture dated as of [_____] 1, 2023 (the "Master Indenture"), as supplemented by a First Supplemental Trust Indenture, dated as [_____] 1, 2023 (the "First Supplemental Indenture" and, together with the Master Indenture, the "Indenture"), each by and between the District and U.S. Bank Trust Company, National Association, as trustee (the "Trustee"). Capitalized terms not otherwise defined herein shall have the meanings assigned to them in the Indenture. See "APPENDIX B: PROPOSED FORMS OF MASTER INDENTURE AND FIRST SUPPLEMENTAL INDENTURE" hereto.

The Assessment Area One Bonds are being issued for the purposes of: (i) providing funds to pay all or a portion of the costs of the planning, financing, acquisition, construction, equipping and installation of the Assessment Area One Project, (ii) funding a deposit to the Assessment Area One Reserve Account in the amount of the Assessment Area One Reserve Requirement (each as defined herein), (iii) paying a portion of the interest coming due on the Assessment Area One Bonds and (iv) paying the costs of issuance of the Assessment Area One Bonds. See "ESTIMATED SOURCES AND USES OF FUNDS" herein.

The Assessment Area One Bonds are payable from and secured solely by the Assessment Area One Pledged Revenues. The Assessment Area One Pledged Revenues for the Assessment Area One Bonds consist of (a) all revenues received by the District from the Assessment Area One Special Assessments levied and collected from Assessment Area One, including without limitation, amounts received from any foreclosure proceeding for the enforcement of collection of such Assessment Area One Special Assessments or from the issuance and sale of tax certificates with respect to such Assessment Area One Special Assessments, and (b) all moneys on deposit in the Funds and Accounts established under the Indenture, created and established with respect to or for the benefit of the Assessment Area One Bonds; provided, however, that the Assessment Area One Pledged Revenues shall not include (A) any moneys transferred to the Assessment Area One Rebate Fund and investment earnings thereon, (B) moneys on deposit in the Assessment Area One Costs of Issuance Account of the Acquisition and Construction Fund and (C) "special assessments" levied and collected by the District under Section 190.022 of the Act, for maintenance purposes or "maintenance assessments" levied and collected by the District under Section 190.021(3) of the Act (it being expressly understood that the lien and pledge of the Indenture shall not apply to any of the moneys described in the foregoing clauses of (A), (B) and (C) of this proviso). See "SECURITY FOR AND SOURCE OF PAYMENT OF THE ASSESSMENT AREA ONE BONDS" herein.

Set forth herein are brief descriptions of the District, Assessment Area One, the Assessment Area One Project, the Developer and the Development, together with summaries of terms of Assessment Area One Bonds, the Indenture, and certain provisions of the Act. All references herein to the Indenture and the Act are qualified in their entirety by reference to such documents and the Act and all references to the Assessment Area One Bonds are qualified by reference to the definitive forms thereof and the information with respect thereto contained in the Indenture. Proposed forms of the Master Indenture and the First Supplemental Indenture appear as APPENDIX B attached hereto.

This Limited Offering Memorandum speaks only as of its date and the information contained herein is subject to change.

DESCRIPTION OF THE ASSESSMENT AREA ONE BONDS

General Description

The Assessment Area One Bonds are being issued only in fully registered form, in denominations of \$5,000 or any integral multiples thereof (an "Authorized Denomination"). The Assessment Area One Bonds will initially be sold only to "accredited investors" within the meaning of Chapter 517, Florida Statutes, as amended, and the rules promulgated thereunder by the Florida Department of Financial Services. The limitation of the initial offering to accredited investors does not denote restrictions on transfers in any secondary market for the Assessment Area One Bonds. See "SUITABILITY FOR INVESTMENT" herein.

The Assessment Area One Bonds shall be dated as of the date of initial delivery. Interest on the Assessment Area One Bonds shall be payable on each Interest Payment Date to maturity or prior redemption. "Interest Payment Date" means May 1 and November 1 of each year, commencing May 1, 2024. Interest on the Assessment Area One Bonds shall be payable from the most recent Interest Payment Date next preceding the date of authentication thereof to which interest has been paid, unless the date of authentication thereof is a May 1 or November 1 to which interest has been paid, in which case from such date of authentication, or unless the date of authentication thereof is prior to May 1, 2024, in which case from the date of initial delivery or unless the date of authentication thereof is between a Record Date and the next succeeding Interest Payment Date, in which case from such Interest Payment Date. U.S. Bank Trust Company, National Association is the initial Trustee, Paying Agent and Registrar for the Assessment

Area One Bonds. Interest on the Assessment Area One Bonds will be computed in all cases on the basis of a 360-day year consisting of twelve 30-day months.

Upon initial issuance, the Assessment Area One Bonds shall be issued as one fully registered bond for each maturity of Assessment Area One Bonds and deposited with The Depository Trust Company ("DTC"), New York, New York, which is responsible for establishing and maintaining records of ownership for its participants. As long as the Assessment Area One Bonds are held in book-entry-only form, Cede & Co. shall be considered the registered owner for all purposes of the Indenture. DTC shall be responsible for maintaining a book-entry-only system for recording the ownership interest of its participants ("Direct Participants") and other institutions that clear through or maintain a custodial relationship with a Direct Participant, either directly or indirectly ("Indirect Participants"). The Direct Participants and Indirect Participants will be responsible for maintaining records with respect to the beneficial ownership interests of individual purchasers of the Assessment Area One Bonds ("Beneficial Owners"). Principal and interest on the Assessment Area One Bonds registered in the name of Cede & Co. prior to and at maturity shall be payable directly to Cede & Co. in care of DTC. Disbursal of such amounts to Direct Participants shall be the responsibility of DTC. Payments by Direct Participants to Indirect Participants, and by Direct Participants and Indirect Participants to Beneficial Owners shall be the responsibility of Direct Participants and Indirect Participants and not of DTC, the Trustee or the District. During the period for which Cede & Co. is registered owner of the Assessment Area One Bonds, any notices to be provided to any Beneficial Owner will be provided to Cede & Co. DTC shall be responsible for notices to Direct Participants and Direct Participants shall be responsible for notices to Indirect Participants, and Direct Participants and Indirect Participants shall be responsible for notices to Beneficial Owners. In the event DTC, any successor of DTC or the District, but only in accordance with the procedures of DTC, elects to discontinue the book-entry only system for the Assessment Area One Bonds, the Trustee shall deliver bond certificates in accordance with the instructions from DTC or its successor, and after such time the Assessment Area One Bonds may be exchanged for an equal aggregate principal amount of such Assessment Area One Bonds in other Authorized Denominations upon surrender thereof at the designated corporate trust office of the Trustee. See "– Book-Entry Only System" herein.

U.S. Bank Trust Company, National Association is the initial Trustee, Paying Agent and Registrar for the Assessment Area One Bonds.

Redemption Provisions

Optional Redemption

The Assessment Area One Bonds maturing after May 1, 20__ may, at the option of the District be called for redemption prior to maturity as a whole or in part, at any time, on or after May 1, 20__ (less than all Assessment Area One Bonds of a maturity to be selected by lot), at a Redemption Price equal to the principal amount of Assessment Area One Bonds to be redeemed, plus accrued interest from the most recent Interest Payment Date through which interest has been paid to the redemption date from moneys on deposit in the Assessment Area One Optional Redemption Subaccount of the Assessment Area One Bond Redemption Account. If such optional redemption shall be in part, the District shall select such principal amount of Assessment Area One Bonds to be optionally redeemed from each maturity so that debt service on the remaining Outstanding Assessment Area One Bonds is substantially level.

Mandatory Sinking Fund Redemption

The Assessment Area One Bonds maturing on May 1, 20__ are subject to mandatory sinking fund redemption from the moneys on deposit in the Assessment Area One Sinking Fund Account on May 1 in

the years and in the mandatory sinking fund redemption amounts set forth below at a Redemption Price of 100% of their principal amount plus accrued interest to the date of redemption.

<u>Year</u>	<u>Mandatory Sinking Fund Redemption Amount</u>
	\$

*

*Maturity

The Assessment Area One Bonds maturing on May 1, 20__ are subject to mandatory sinking fund redemption from the moneys on deposit in the Assessment Area One Sinking Fund Account on May 1 in the years and in the mandatory sinking fund redemption amounts set forth below at a Redemption Price of 100% of their principal amount plus accrued interest to the date of redemption.

<u>Year</u>	<u>Mandatory Sinking Fund Redemption Amount</u>
	\$

*

*Maturity

The Assessment Area One Bonds maturing on May 1, 20__ are subject to mandatory sinking fund redemption from the moneys on deposit in the Assessment Area One Sinking Fund Account on May 1 in the years and in the mandatory sinking fund redemption amounts set forth below at a Redemption Price of 100% of their principal amount plus accrued interest to the date of redemption.

<u>Year</u>	<u>Mandatory Sinking Fund Redemption Amount</u>
	\$

*

*Maturity

The Assessment Area One Bonds maturing on May 1, 20__ are subject to mandatory sinking fund redemption from the moneys on deposit in the Assessment Area One Sinking Fund Account on May 1 in the years and in the mandatory sinking fund redemption amounts set forth below at a Redemption Price of 100% of their principal amount plus accrued interest to the date of redemption.

<u>Year</u>	<u>Mandatory Sinking Fund Redemption Amount</u>
	\$

*

*Maturity

Upon any redemption of Assessment Area One Bonds other than in accordance with scheduled mandatory sinking fund redemption amounts, the District shall cause to be recalculated and delivered to the Trustee revised mandatory sinking fund redemption amounts recalculated so as to amortize the Outstanding principal amount of Assessment Area One Bonds in substantially equal annual installments of principal and interest (subject to rounding to Authorized Denominations of principal) over the remaining term of the Assessment Area One Bonds. The mandatory sinking fund redemption amounts as so recalculated shall not result in an increase in the aggregate of the mandatory sinking fund redemption amounts for all Assessment Area One Bonds in any year. In the event of a redemption or purchase occurring less than 45 days prior to a date on which a mandatory sinking fund redemption payment is due, the foregoing recalculation shall not be made to the mandatory sinking fund redemption amounts due in the year in which such redemption or purchase occurs, but shall be made to the mandatory sinking fund redemption amounts for the immediately succeeding and subsequent years.

Extraordinary Mandatory Redemption

The Assessment Area One Bonds are subject to extraordinary mandatory redemption prior to maturity by the District in whole or in part, on any date (other than in the case of clause (i) below, which extraordinary mandatory redemption in part must occur on a Quarterly Redemption Date), at a Redemption Price equal to 100% of the principal amount of the Assessment Area One Bonds to be redeemed, plus interest accrued to the redemption date, as follows:

(i) from Assessment Area One Prepayment Principal deposited into the Assessment Area One Prepayment Subaccount of the Assessment Area One Bond Redemption Account following the payment in whole or in part of Assessment Area One Special Assessments on any assessable property within the District in accordance with the provisions of the First Supplemental Indenture, together with any excess moneys transferred by the Trustee from the Assessment Area One Reserve Account to the Assessment Area One Prepayment Subaccount as a result of such Prepayment and pursuant the First Supplemental Indenture. If such redemption shall be in part, the District shall select such principal amount of Assessment Area One Bonds to be redeemed from each maturity so that debt service on the remaining Outstanding Assessment Area One Bonds is substantially level;

(ii) from moneys, if any, on deposit in the Funds, Accounts and subaccounts held by the Trustee within the First Supplemental Indenture (other than the Assessment Area One Rebate Fund and the Assessment Area One Acquisition and Construction Account) sufficient to pay and redeem all Outstanding Assessment Area One Bonds and accrued interest thereon to the redemption date or dates in addition to all amounts owed to Persons under the Master Indenture; and

(iii) upon the Completion Date, from any funds remaining on deposit in the Assessment Area One Acquisition and Construction Account in accordance with the provisions of the First Supplemental Indenture, not otherwise reserved to complete the Assessment Area One Project and transferred to the Assessment Area One General Redemption Subaccount of the Assessment Area One Bond Redemption Account, together with moneys deposited therein in accordance with the provisions of the First Supplemental Indenture, as a result of the reduction of the Assessment Area One Reserve Requirement. If such redemption shall be in part, the District shall select such principal amount of Assessment Area One Bonds to be redeemed from each maturity so that debt service on the remaining Outstanding Assessment Area One Bonds is substantially level.

Notice of Redemption

When required to redeem or purchase Assessment Area One Bonds under any provision of the Indenture or directed to do so by the District, the Trustee shall cause notice of the redemption, either in

whole or in part, to be mailed at least thirty (30) but not more than sixty (60) days prior to the redemption or purchase date to all Owners of Assessment Area One Bonds to be redeemed or purchased (as such Owners appear on the Bond Register on the fifth (5th) day prior to such mailing), at their registered addresses, but failure to mail any such notice or defect in the notice or in the mailing thereof shall not affect the validity of the redemption or purchase of the Assessment Area One Bonds for which notice was duly mailed in accordance with the Indenture. If, at the time of mailing of notice of an optional redemption, the District shall not have deposited with the Trustee or Paying Agent moneys sufficient to redeem or purchase all of the Assessment Area One Bonds called for redemption, such notice shall expressly state that the redemption is conditional and is subject to the deposit of the redemption moneys with the Trustee or Paying Agent, as the case may be, not later than the opening of business on the redemption date or purchase date, and such notice shall be of no effect unless such moneys are so deposited.

Purchase of Assessment Area One Bonds

At the written direction of the District, the Trustee shall apply moneys from time to time available in the Assessment Area One Sinking Fund Account to the purchase of the Assessment Area One Bonds in accordance with the Indenture, at prices not higher than the principal amount thereof, in lieu of redemption, provided that firm purchase commitments can be made before the notice of redemption would otherwise be required to be given.

Book-Entry Only System

The Depository Trust Company ("DTC"), New York, New York, will act as securities depository for the Assessment Area One Bonds. The Assessment Area One Bonds will be issued as fully-registered securities registered in the name of Cede & Co. (DTC's partnership nominee) or such other name as may be requested by an authorized representative of DTC. One fully-registered Assessment Area One Bond certificate will be issued for each maturity of the Assessment Area One Bonds, each in the aggregate principal amount of such maturity, and will be deposited with DTC.

DTC, the world's largest securities depository, is a limited-purpose trust company organized under the New York Banking Law, a "banking organization" within the meaning of the New York Banking Law, a member of the Federal Reserve System, a "clearing corporation" within the meaning of the New York Uniform Commercial Code, and a "clearing agency" registered pursuant to the provisions of Section 17A of the Securities Exchange Act of 1934. DTC holds and provides asset servicing for over 3.5 million issues of U.S. and non-U.S. equity issues, corporate and municipal debt issues, and money market instruments (from over 100 countries) that DTC's participants ("Direct Participants") deposit with DTC. DTC also facilitates the post-trade settlement among Direct Participants of sales and other securities transactions in deposited securities, through electronic computerized book-entry transfers and pledges between Direct Participants' accounts. This eliminates the need for physical movement of securities certificates. Direct Participants include both U.S. and non-U.S. securities brokers and dealers, banks, trust companies, clearing corporations, and certain other organizations. DTC is a wholly-owned subsidiary of The Depository Trust & Clearing Corporation ("DTCC"). DTCC is the holding company for DTC, National Securities Clearing Corporation and Fixed Income Clearing Corporation, all of which are registered clearing agencies. DTCC is owned by the users of its regulated subsidiaries. Access to the DTC system is also available to others such as both U.S. and non-U.S. securities brokers and dealers, banks, trust companies, and clearing corporations that clear through or maintain a custodial relationship with a Direct Participant, either directly or indirectly ("Indirect Participants"). DTC has a Standard & Poor's rating of AA+. The DTC Rules applicable to its Participants are on file with the Securities and Exchange Commission. More information about DTC can be found at www.dtcc.com.

Purchases of Assessment Area One Bonds under the DTC system must be made by or through Direct Participants, which will receive a credit for the Assessment Area One Bonds on DTC's records. The ownership interest of each actual purchaser of each Assessment Area One Bond ("Beneficial Owner") is in turn to be recorded on the Direct and Indirect Participants' records. Beneficial Owners will not receive written confirmation from DTC of their purchase. Beneficial Owners are, however, expected to receive written confirmations providing details of the transaction, as well as periodic statements of their holdings, from the Direct or Indirect Participant through which the Beneficial Owner entered into the transaction. Transfers of ownership interests in the Assessment Area One Bonds are to be accomplished by entries made on the books of Direct and Indirect Participants acting on behalf of Beneficial Owners. Beneficial Owners will not receive certificates representing their ownership interests in Assessment Area One Bonds, except in the event that use of the book-entry system for the Assessment Area One Bonds is discontinued.

To facilitate subsequent transfers, all Assessment Area One Bonds deposited by Direct Participants with DTC are registered in the name of DTC's partnership nominee, Cede & Co., or such other name as may be requested by an authorized representative of DTC. The deposit of Assessment Area One Bonds with DTC and their registration in the name of Cede & Co. or such other DTC nominee do not affect any change in beneficial ownership. DTC has no knowledge of the actual Beneficial Owners of the Assessment Area One Bonds; DTC's records reflect only the identity of the Direct Participants to whose accounts such Assessment Area One Bonds are credited, which may or may not be the Beneficial Owners. The Direct and Indirect Participants will remain responsible for keeping account of their holdings on behalf of their customers.

Conveyance of notices and other communications by DTC to Direct Participants, by Direct Participants to Indirect Participants, and by Direct Participants and Indirect Participants to Beneficial Owners will be governed by arrangements among them, subject to any statutory or regulatory requirements as may be in effect from time to time. Beneficial Owners of Assessment Area One Bonds may wish to take certain steps to augment the transmission to them of notices of significant events with respect to the Assessment Area One Bonds, such as redemptions, tenders, defaults, and proposed amendments to the Assessment Area One Bond documents. For example, Beneficial Owners of Assessment Area One Bonds may wish to ascertain that the nominee holding the Assessment Area One Bonds for their benefit has agreed to obtain and transmit notices to Beneficial Owners. In the alternative, Beneficial Owners may wish to provide their names and addresses to the registrar and request that copies of notices be provided directly to them.

Redemption notices shall be sent to DTC. If less than all of the Assessment Area One Bonds within a series or maturity are being redeemed, DTC's practice is to determine by lot the amount of the interest of each Direct Participant in such series or maturity to be redeemed.

Neither DTC nor Cede & Co. (nor any other DTC nominee) will consent or vote with respect to Assessment Area One Bonds unless authorized by a Direct Participant in accordance with DTC's MMI Procedures. Under its usual procedures, DTC mails an Omnibus Proxy to the District as soon as possible after the record date. The Omnibus Proxy assigns Cede & Co.'s consenting or voting rights to those Direct Participants to whose accounts Assessment Area One Bonds are credited on the record date (identified in a listing attached to the Omnibus Proxy).

Redemption proceeds, distributions, and dividend payments on the Assessment Area One Bonds will be made to Cede & Co., or such other nominee as may be requested by an authorized representative of DTC. DTC's practice is to credit Direct Participants' accounts upon DTC's receipt of funds and corresponding detail information from the District or the Trustee, on payable date in accordance with their respective holdings shown on DTC's records. Payments by Participants to Beneficial Owners will be governed by standing instructions and customary practices, as is the case with securities held for the

accounts of customers in bearer form or registered in "street name," and will be the responsibility of such Participant and not of DTC, the Trustee, or the District, subject to any statutory or regulatory requirements as may be in effect from time to time. Payment of redemption proceeds, distributions, and dividend payments to Cede & Co. (or such other nominee as may be requested by an authorized representative of DTC) is the responsibility of the District or the Trustee, disbursement of such payments to Direct Participants will be the responsibility of DTC, and disbursement of such payments to the Beneficial Owners will be the responsibility of Direct and Indirect Participants.

A Beneficial Owner shall give notice to elect to have its Assessment Area One Bonds purchased or tendered, through its Participant, to the Trustee, and shall effect delivery of such Assessment Area One Bonds by causing the Direct Participant to transfer the Participant's interest in the Assessment Area One Bonds, on DTC's records, to the Trustee. The requirement for physical delivery of Assessment Area One Bonds in connection with an optional tender or a mandatory purchase will be deemed satisfied when the ownership rights in the Assessment Area One Bonds are transferred by Direct Participants on DTC's records and followed by a book-entry credit of tendered Assessment Area One Bonds to the Trustee's DTC account.

DTC may discontinue providing its services as depository with respect to the Assessment Area One Bonds at any time by giving reasonable notice to the District or the Trustee. Under such circumstances, in the event that a successor depository is not obtained, Assessment Area One Bond certificates are required to be printed and delivered.

The District may decide to discontinue use of the system of book-entry-only transfers through DTC (or a successor securities depository) pursuant to the procedures of DTC. In that event, Security certificates will be printed and delivered to DTC.

The information in this section concerning DTC and DTC's book-entry system has been obtained from sources that the District believes to be reliable, but the District takes no responsibility for the accuracy thereof.

SECURITY FOR AND SOURCE OF PAYMENT OF THE ASSESSMENT AREA ONE BONDS

General

THE ASSESSMENT AREA ONE BONDS ARE LIMITED OBLIGATIONS OF THE DISTRICT PAYABLE SOLELY FROM THE ASSESSMENT AREA ONE PLEDGED REVENUES PLEDGED THEREFOR UNDER THE INDENTURE, AND NEITHER THE PROPERTY, THE FULL FAITH AND CREDIT, NOR THE TAXING POWER OF THE DISTRICT, THE COUNTY, THE STATE, OR ANY OTHER POLITICAL SUBDIVISION THEREOF, IS PLEDGED AS SECURITY FOR THE PAYMENT OF THE ASSESSMENT AREA ONE BONDS, EXCEPT THAT THE DISTRICT IS OBLIGATED UNDER THE INDENTURE TO LEVY AND TO EVIDENCE AND CERTIFY, OR CAUSE TO BE CERTIFIED, FOR COLLECTION ASSESSMENT AREA ONE SPECIAL ASSESSMENTS TO SECURE AND PAY THE ASSESSMENT AREA ONE BONDS. THE ASSESSMENT AREA ONE BONDS DO NOT CONSTITUTE AN INDEBTEDNESS OF THE DISTRICT, THE COUNTY, THE STATE, OR ANY OTHER POLITICAL SUBDIVISION THEREOF WITHIN THE MEANING OF ANY CONSTITUTIONAL OR STATUTORY PROVISION OR LIMITATION.

The Assessment Area One Bonds are payable from and secured solely by the Assessment Area One Pledged Revenues. The Assessment Area One Pledged Revenues for the Assessment Area One Bonds consist of (a) all revenues received by the District from the Assessment Area One Special Assessments (as defined herein) levied and collected from Assessment Area One, including without limitation, amounts received from any foreclosure proceeding for the enforcement of collection of such Assessment Area One

Special Assessments or from the issuance and sale of tax certificates with respect to such Assessment Area One Special Assessments, and (b) all moneys on deposit in the Funds and Accounts established under the Indenture, created and established with respect to or for the benefit of the Assessment Area One Bonds; provided, however, that the Assessment Area One Pledged Revenues shall not include (A) any moneys transferred to the Assessment Area One Rebate Fund and investment earnings thereon, (B) moneys on deposit in the Assessment Area One Costs of Issuance Account of the Acquisition and Construction Fund and (C) "special assessments" levied and collected by the District under Section 190.022 of the Act, for maintenance purposes or "maintenance assessments" levied and collected by the District under Section 190.021(3), of the Act (it being expressly understood that the lien and pledge of the Indenture shall not apply to any of the moneys described in the foregoing clauses of (A), (B) and (C) of this proviso).

The "Assessment Area One Special Assessments" consist of the non-ad valorem special assessments imposed and levied by the District against the assessable lands within the District specially benefited by the Assessment Area One Project, or any portions thereof, pursuant to Section 190.022 of the Act, Chapters 170 and 197, Florida Statutes, and the Assessment Resolutions (as defined in the Indenture) and assessment proceedings conducted by the District (together with the Assessment Resolutions, the "Assessment Proceedings"). Non-ad valorem assessments are not based on millage and are not taxes, but constitute a lien against the land as to which the Assessment Area One Special Assessments are imposed, including homestead property as permitted in Section 4, Article X of the Florida State Constitution. The Assessment Area One Special Assessments will constitute a lien against the land as to which the Assessment Area One Special Assessments are imposed. See "ENFORCEMENT OF ASSESSMENT COLLECTIONS" herein. The Assessment Area One Special Assessments will initially be levied on all of gross acres of land within Assessment Area One of the District.

The Assessment Area One Special Assessments are levied in an amount corresponding to the debt service on the Assessment Area One Bonds on the basis of benefit received by the assessable lands within the District as a result of the Assessment Area One Project. The Assessment Methodology (as hereinafter defined), which describes the methodology for allocating the Assessment Area One Special Assessments to the assessable lands within the District, is included as APPENDIX D attached hereto.

In the Master Indenture, the District will covenant that, if any Assessment Area One Special Assessment shall be either in whole or in part annulled, vacated or set aside by the judgment of any court, or if the District shall be satisfied that any such Assessment Area One Special Assessment is so irregular or defective that the same cannot be enforced or collected, or if the District shall have omitted to make such Assessment Area One Special Assessment when it might have done so, the District shall either (i) take all necessary steps to cause a new Assessment Area One Special Assessment to be made for the whole or any part of such improvement or against any property benefited by such improvement or (ii) in its sole discretion, make up the amount of such Assessment Area One Special Assessment from any legally available moneys, which shall be deposited into the Assessment Area One Revenue Account. In the case such second Assessment Area One Special Assessment shall be annulled, the District shall obtain and make other Assessment Area One Special Assessments until a valid Assessment Area One Special Assessment shall be made.

Prepayment of Assessment Area One Special Assessments

The Assessment Proceedings provide that an owner of property subject to the Assessment Area One Special Assessments may prepay the entire remaining balance of such Assessment Area One Special Assessments at any time, or a portion of the remaining balance of such Assessment Area One Special Assessment one time, if there is also paid, in addition to the prepaid principal balance of the Assessment Area One Special Assessment, an amount equal to the interest that would otherwise be due on such prepaid amount on the next succeeding interest payment date for the Assessment Area One Bonds or, if prepaid

during the forty-five (45) day period preceding such interest payment date, to the interest payment date following such next succeeding interest payment date. Prepayment of the Assessment Area One Special Assessments does not entitle the property owner to any discounts for early payment.

Pursuant to the Act and the Assessment Proceedings, an owner of property subject to the levy of Assessment Area One Special Assessments may pay the entire balance of the Assessment Area One Special Assessments remaining due, without interest, within thirty (30) days after the Assessment Area One Project has been completed, and the Board has adopted a resolution accepting the Assessment Area One Project pursuant to Chapter 170.09, Florida Statutes. The Developer, [as the sole owner of the assessable property in Assessment Area One within the District,] will waive this right on behalf of itself and its successors and assigns in connection with the issuance of the Assessment Area One Bonds. See "BONDOWNERS' RISKS – Prepayment and Redemption Risk" herein.

The Assessment Area One Bonds are subject to extraordinary mandatory redemption as indicated under "DESCRIPTION OF THE ASSESSMENT AREA ONE BONDS – Redemption Provisions – Extraordinary Mandatory Redemption" from optional and required prepayments of Assessment Area One Special Assessments by property owners.

Additional Bonds

Under the Indenture, the District will covenant not to issue any other Bonds or other debt obligations secured by the Assessment Area One Special Assessments. In addition, the District will covenant not to issue any other Bonds or debt obligations for capital projects secured by Special Assessments on the assessable lands within the District that are subject to the Assessment Area One Special Assessments, until the Assessment Area One Special Assessments are Substantially Absorbed. "Substantially Absorbed" means the date at least 75% of the principal portion of the Assessment Area One Special Assessments have been assigned to residential units within Assessment Area One that have received certificates of occupancy. The District shall present the Trustee with a certification that the Assessment Area One Special Assessments are Substantially Absorbed, and the Trustee may rely conclusively upon such certification and shall have no duty to verify if the Assessment Area One Special Assessments are Substantially Absorbed. In the absence of such written certification, the Trustee is entitled to assume that the Assessment Area One Special Assessments have not been Substantially Absorbed. Such covenant shall not prohibit the District from issuing refunding Bonds or any Bonds or other obligations secured by Special Assessments levied on District Lands [outside of Assessment Area One], or to finance any other capital project that is necessary to remediate any natural disaster, catastrophic damage or failure with respect to the Assessment Area One Project.

The District, subject to the limitations set forth in the preceding paragraph, and/or other public entities may impose taxes or other special assessments on the same properties encumbered by the Assessment Area One Special Assessments without the consent of the Owners of the Assessment Area One Bonds. The District expects to impose certain non-ad valorem special assessments called maintenance assessments, which are of equal dignity with the Assessment Area One Special Assessments on the same lands upon which the Assessment Area One Special Assessments are imposed, to fund the maintenance and operation of the District. See "THE DEVELOPMENT – Taxes, Fees and Assessments" and "BONDOWNERS' RISKS" herein for more information.

Covenant Against Sale or Encumbrance

In the Master Indenture, the District will covenant that (a) except for those improvements comprising the Projects that are to be conveyed by the District to the County, the State Department of Transportation or another governmental entity, as to which no assessments of the District will be imposed

and (b) except as otherwise permitted in the Master Indenture, it will not sell, lease or otherwise dispose of or encumber any Projects or any part thereof. See "APPENDIX B: PROPOSED FORMS OF MASTER INDENTURE AND FIRST SUPPLEMENTAL INDENTURE" herein.

Acquisition and Construction Account

The Indenture establishes a separate account within the Acquisition and Construction Fund designated as the "Assessment Area One Acquisition and Construction Account." Net proceeds of the Assessment Area One Bonds shall initially be deposited into the Assessment Area One Acquisition and Construction Account in the amount set forth in the First Supplemental Indenture, together with any moneys subsequently transferred or deposited thereto, including moneys transferred from the Assessment Area One Reserve Account after satisfaction of either the Reserve Release Conditions #1 or Reserve Release Conditions #2 (as defined herein), as certified in writing by the District Manager and upon which the Trustee may conclusively rely, and such moneys shall be applied as set forth in the Indenture, the Acquisition Agreement and the Engineer's Report. Funds on deposit in the Assessment Area One Acquisition and Construction Account shall only be requested by the District to be applied to the Costs of the Assessment Area One Project, subject to the First Supplemental Indenture. Upon satisfaction of the Release Conditions #1 and Reserve Release Conditions #2, the amount on deposit in the Assessment Area One Reserve Account in excess of the Assessment Area One Reserve Requirement, as applicable and as calculated by the District shall then be transferred by the Trustee to the Assessment Area One Acquisition and Construction Account, as directed in writing to the Trustee by the District Manager, upon consultation with the Consulting Engineer, and applied as provided in the First Supplemental Indenture. See "-Reserve Account" herein for more information on the Reserve Release Conditions #1 or Reserve Release Conditions #2.

Following the Completion Date for the Assessment Area One Project, all moneys remaining in the Assessment Area One Acquisition and Construction Account that have not been requisitioned within thirty (30) days after satisfaction of the Reserve Release Conditions #2, shall be transferred to the Assessment Area One General Redemption Subaccount, as directed in writing by the District Manager on behalf of the District to the Trustee to be applied as set forth in the First Supplemental Indenture. Notwithstanding the foregoing, the Assessment Area One Acquisition and Construction Account shall not be closed until the Reserve Release Conditions #2 shall have occurred and the excess funds from the Assessment Area One Reserve Account shall have been transferred to the Assessment Area One Acquisition and Construction Account, as directed in writing to the Trustee by the District Manager, and applied in accordance with the First Supplemental Indenture. The Trustee shall not be responsible for determining the amount in the Assessment Area One Acquisition and Construction Account and subaccounts allocable to the Assessment Area One Project or any transfers made to such Accounts in accordance with direction from the District Manager.

The Trustee shall make no such transfers from the Assessment Area One Acquisition and Construction Account to the Assessment Area One General Redemption Subaccount if an Event of Default exists, with respect to the Assessment Area One Bonds of which the Trustee has actual knowledge as described in the Master Indenture. Except as provided in the First Supplemental Indenture, only upon presentment to the Trustee of a properly signed requisition in substantially the form attached to the First Supplemental Indenture shall the Trustee withdraw moneys from the Assessment Area One Acquisition and Construction Account. After no funds remain in the Assessment Area One Acquisition and Construction Account, such Account shall be closed.

Anything in the Indenture to the contrary notwithstanding, the District will acknowledge in the First Supplemental Indenture that the Assessment Area One Pledged Revenues securing the Assessment Area One Bonds include, without limitation, all amounts on deposit in the Assessment Area One Acquisition and Construction Account of the Acquisition and Construction Fund then held by the Trustee,

and upon the occurrence of an Event of Default with respect to the Assessment Area One Bonds, (i) the Assessment Area One Pledged Revenues may not be used by the District (whether to pay costs of the Assessment Area One Project or otherwise) without the consent of the Majority Holders and (ii) the Assessment Area One Pledged Revenues may be used by the Trustee, at the direction or with the approval of the Majority Holders, to pay costs and expenses incurred in connection with the pursuit of remedies under the Assessment Area One Indenture, provided, however notwithstanding anything in the Indenture to the contrary, the Trustee is also authorized to utilize the Assessment Area One Pledged Revenues to pay fees and expenses as provided in the Master Indenture.

Reserve Account

The Indenture establishes an "Assessment Area One Reserve Account" within the Debt Service Reserve Fund solely for the benefit of the Assessment Area One Bonds. Net proceeds of the Assessment Area One Bonds shall be deposited into the Assessment Area One Reserve Account in the amount of the Assessment Area One Reserve Requirement, and such moneys, together with any other moneys deposited into the Assessment Area One Reserve Account shall be applied for the purposes provided in the Indenture.

"Assessment Area One Reserve Requirement" or "Reserve Requirement" shall be (i) initially, an amount equal to the maximum annual debt service on the Assessment Area One Bonds as calculated from time to time; (ii) upon the occurrence of the Reserve Release Conditions #1, fifty percent (50%) of the maximum annual debt service on the Assessment Area One Bonds as calculated from time to time; and (iii) upon the occurrence of the Reserve Release Conditions #2, ten percent (10%) of the maximum annual debt service on the Assessment Area One Bonds as calculated from time to time. Upon satisfaction of the Reserve Release Conditions #1 or Reserve Release Conditions #2, as applicable, such excess amount shall be released from the Assessment Area One Reserve Account and transferred to the Assessment Area One Acquisition and Construction Account in accordance with the provisions of the First Supplemental Indenture. For the purpose of calculating the Assessment Area One Reserve Requirement, maximum annual debt service, fifty percent (50%) of the maximum annual debt service, or ten percent (10%) of the maximum annual debts service, as the case may be, shall be recalculated in connection with the extraordinary mandatory redemption described in the First Supplemental Indenture (but not upon the optional or mandatory sinking fund redemption thereof) and such excess amount shall be released from the Assessment Area One Reserve Account and, other than as provided in the immediately preceding sentence, transferred to the Assessment Area One General Redemption Subaccount or the Assessment Area One Prepayment Subaccount, as applicable, in accordance with the provisions of the First Supplemental Indenture. Amounts on deposit in the Assessment Area One Reserve Account may, upon final maturity or redemption of all Outstanding Assessment Area One Bonds be used to pay principal of and interest on the Assessment Area One Bonds at that time. Initially, the Assessment Area One Reserve Requirement shall be equal to \$_____.

"Reserve Release Conditions #1" shall mean collectively (i) all lots subject to the Assessment Area One Special Assessments have been developed and platted, , and (ii) there shall be no Events of Default under the Assessment Area One Indenture, all as certified by the District Manager in writing and upon which the Trustee may conclusively rely.

"Reserve Release Conditions #2" shall mean collectively (i) satisfaction of Reserve Release Conditions #1, and (ii) all homes subject to the Assessment Area One Special Assessments have been built and have received a certificate of occupancy, (iii) all of the principal portion of the Assessment Area One Special Assessments has been assigned to such homes, and (iv) there shall be no Events of Default under the Assessment Area One Indenture, all as certified by the District Manager in writing and upon which the Trustee may conclusively rely.

Notwithstanding any provisions in the Master Indenture to the contrary, the District will covenant in the Indenture not to substitute the cash and Investment Securities on deposit in the Assessment Area One Reserve Account with a Debt Service Reserve Insurance Policy or a Debt Service Reserve Letter of Credit. Except as provided in the next paragraph, all investment earnings on moneys in the Assessment Area One Reserve Account shall remain on deposit therein.

[On each March 15 and September 15 (or, if such date is not a Business Day, on the Business Day next preceding such day), the Trustee shall determine the amount on deposit in the Assessment Area One Reserve Account and transfer any excess therein above the Assessment Area One Reserve Requirement resulting from investment earnings to the Assessment Area One Revenue Account in accordance with the Indenture.]

Subject to the provisions of the First Supplemental Indenture, on any date the District receives notice from the District Manager that a landowner wishes to prepay its Assessment Area One Special Assessments relating to the benefited property of such landowner within Assessment Area One, or as a result of a mandatory true-up payment, the District shall, or shall cause the District Manager on behalf of the District to calculate, the principal amount of such Prepayment, taking into account a credit against the amount of the Assessment Area One Prepayment Principal due by the amount of money in the Assessment Area One Reserve Account that will exceed the Assessment Area One Reserve Requirement for the Assessment Area One Bonds, taking into account the proposed Prepayment. Such excess shall be transferred to the Assessment Area One Prepayment Subaccount of the Assessment Area One Bond Redemption Account, as a result of such Prepayment. The District Manager, on behalf of the District, shall make such calculation within ten (10) Business Days after such Prepayment and shall instruct the Trustee in writing to transfer such amount of credit given to the respective landowner from the Assessment Area One Reserve Account to the Assessment Area One Prepayment Subaccount of the Assessment Area One Bond Redemption Account to be used for the extraordinary mandatory redemption of the Assessment Area One Bonds in accordance with the Indenture. The Trustee is authorized to make such transfers and has no duty to verify such calculations. Notwithstanding any of the foregoing, amounts on deposit in the Assessment Area One Reserve Account shall be transferred by the Trustee, in the amounts directed in writing by the Majority Holders of the Assessment Area One Bonds, to the Assessment Area One General Redemption Subaccount, if as a result of the application of the provisions of the Master Indenture with respect to Events of Default, the proceeds received from lands sold subject to the Assessment Area One Special Assessments and applied to redeem a portion of the Assessment Area One Bonds is less than the principal amount of Assessment Area One Bonds indebtedness attributable to such lands.

Notwithstanding the foregoing, upon satisfaction of the Reserve Release Conditions #1 and #2, the Trustee shall deposit such excess as directed by the District Manager in writing on deposit in the Assessment Area One Reserve Account to the Assessment Area One Acquisition and Construction Account and pay such amount as designated in a requisition in the form attached as an exhibit to the First Supplemental Indenture to the District submitted by the Landowner within thirty (30) days of such transfer which requisition shall be executed by the District and the Consulting Engineer. Such payment is authorized notwithstanding that the Completion Date might have been declared provided the Landowner can establish, to the satisfaction of the Consulting Engineer, Costs of the Assessment Area One Project that were not paid from moneys initially deposited in the Assessment Area One Acquisition and Construction Account. In the event that there are no unreimbursed costs to pay to the Landowner, such excess moneys transferred from the Assessment Area One Reserve Account to the Assessment Area One Acquisition and Construction Account shall be deposited into the Assessment Area One General Redemption Subaccount of the Assessment Area One Bond Redemption Account upon direction to the Trustee by the District. If no completed requisition as provided in the First Supplemental Indenture is submitted to the Trustee within thirty (30) days of moneys having been transferred from the Assessment Area One Reserve Account to the Assessment Area One Acquisition and Construction Account as a result of the satisfaction of the Reserve

Release Conditions #1 and #2, such excess moneys in the Assessment Area One Acquisition and Construction Account shall then be transferred by the Trustee to the Assessment Area One General Redemption Subaccount and applied to the redemption of Assessment Area One Bonds as provided in the First Supplemental Indenture.

In addition, and together with the moneys transferred from the Assessment Area One Reserve Account pursuant to the First Supplemental Indenture, if the amount on deposit in the Assessment Area One General Redemption Subaccount is not sufficient to redeem a principal amount of the Assessment Area One Bonds in an Authorized Denomination, the Trustee is authorized to withdraw amounts from the Assessment Area One Revenue Account to round up the amount in the Assessment Area One General Redemption Subaccount to the nearest Authorized Denomination. Notwithstanding the foregoing, no transfers from the Assessment Area One Revenue Account shall be made to pay interest on and/or principal of the Assessment Area One Bonds for the redemption pursuant to the First Supplemental Indenture if as a result the deposits required under the First Supplemental Indenture, as set forth in paragraphs FIRST through FIFTH under the sub-heading "-Deposit and Application of the Pledged Revenues" herein, cannot be made in full.

It shall be an event of default under the Indenture if at any time the amount in the Assessment Area One Reserve Account is less than the Reserve Requirement therefor as a result of the Trustee withdrawing an amount therefrom to satisfy the Debt Service Requirement for the Assessment Area One Bonds and such amount has not been restored within [thirty (30)] days of such withdrawal.

Deposit and Application of the Pledged Revenues

Pursuant to the Indenture, the Trustee shall establish a separate account with the Revenue Fund designated as the "Assessment Area One Revenue Account." Assessment Area One Special Assessments (except for Prepayments of Assessment Area One Special Assessments which shall be identified as such by the District to the Trustee and deposited in the Assessment Area One Prepayment Subaccount) shall be deposited by the Trustee into the Assessment Area One Revenue Account and applied as set forth in the Indenture. The Trustee shall transfer from amounts on deposit in the Assessment Area One Revenue Account to the Funds and Accounts designated below, the following amounts, at the following times and in the following order of priority:

FIRST, upon receipt but no later than the Business Day next preceding each Interest Payment Date, commencing May 1, 2024, to the Assessment Area One Interest Account of the Debt Service Fund, an amount equal to the interest on the Assessment Area One Bonds becoming due on the next succeeding Interest Payment Date, less any amount on deposit in the Assessment Area One Interest Account not previously credited;

SECOND, no later than the Business Day next preceding each May 1, commencing May 1, [2025], to the Assessment Area One Sinking Fund Account, an amount equal to the principal amount of Assessment Area One Bonds subject to sinking fund redemption on such May 1, less any amount on deposit in the Assessment Area One Sinking Fund Account not previously credited;

THIRD, upon receipt but no later than the Business Day next preceding each Interest Payment Date while Assessment Area One Bonds remain Outstanding, to the Assessment Area One Reserve Account, equal to the amount, if any, which is necessary to make the amount on deposit therein equal to the Reserve Requirement for the Assessment Area One Bonds;

FOURTH, notwithstanding the foregoing, at any time the Assessment Area One Bonds are subject to redemption on a date which is not a May 1 or November 1 Interest Payment Date, the Trustee shall be

authorized to transfer to the Assessment Area One Interest Account, the amount necessary to pay interest on the Assessment Area One Bonds subject to redemption on such date; and

FIFTH, subject to the foregoing paragraphs, the balance of any moneys remaining after making the foregoing deposits shall be first deposited into the Assessment Area One Costs of Issuance Account upon the written request of the District to cover any deficiencies in the amount allocated to pay the cost of issuing the Assessment Area One Bonds and next, any balance in the Assessment Area One Revenue Account shall remain on deposit in such Assessment Area One Revenue Account, unless needed to be transferred to the Assessment Area One Prepayment Subaccount for the purposes of rounding the principal amount of a Assessment Area One Bond subject to extraordinary mandatory redemption pursuant to the First Supplemental Indenture to an Authorized Denomination, or unless pursuant to the Arbitrage Certificate, it is necessary to make a deposit into the Assessment Area One Rebate Fund, in which case, the District shall direct the Trustee to make such deposit thereto.

In addition to a redemption of Assessment Area One Bonds from Prepayments on deposit in the Assessment Area One Prepayment Subaccount, the Trustee is further authorized, upon written direction from the District, to transfer from the Assessment Area One Revenue Account to the Assessment Area One General Redemption Subaccount sufficient funds to cause the redemption of the next closest Authorized Denomination of Assessment Area One Bonds, as provided in the First Supplemental Indenture.

Investments

The Trustee shall, as directed by the District in writing, invest moneys held in the Series Accounts in the Debt Service Fund and any Series Account within the Bond Redemption Fund only in Investment Securities (as defined in the Master Indenture). The Trustee shall, as directed by the District in writing, invest moneys held in the Assessment Area One Reserve Account of the Debt Service Reserve Fund in Investment Securities. All deposits in time accounts shall be subject to withdrawal without penalty and all investments shall mature or be subject to redemption by the holder without penalty, not later than the date when the amounts will foreseeably be needed for purposes set forth in the Master Indenture. All securities securing investments under the Indenture shall be deposited with a Federal Reserve Bank, with the trust department of the Trustee, as authorized by law with respect to trust funds in the State, or with a bank or trust company having a combined net capital and surplus of not less than \$50,000,000. The interest and income received upon such investments and any interest paid by the Trustee or any other depository of any Fund or Account and any profit or loss resulting from the sale of securities shall be added or charged to the Fund or Account for which such investments are made; provided, however, that if the amount in any Fund or Account equals or exceeds the amount required to be on deposit therein, subject to the Indenture, any interest and other income so received shall be deposited in the applicable Series Account of the Revenue Fund. Upon written request of the District, or on its own initiative whenever payment is to be made out of any Fund or Account, the Trustee shall sell such securities as may be requested to make the payment and restore the proceeds to the respective Fund or Account in which the securities were held. The Trustee shall not be accountable for any depreciation in the value of any such security or for any loss resulting from the sale thereof. If net proceeds from the sale of securities held in any Fund or Account shall be less than the amount invested and, as a result, the amount on deposit in such Fund or Account is less than the amount required to be on deposit in such Fund or Account, the amount of such deficit shall be transferred to such Fund or Account from the related Series Account of the Revenue Fund. See "APPENDIX B: PROPOSED FORMS OF MASTER INDENTURE AND FIRST SUPPLEMENTAL INDENTURE" attached hereto.

Indenture Provisions Relating to Bankruptcy or Insolvency of a Landowner

For purposes of the following, (a) the Assessment Area One Bonds secured by and payable from Special Assessments levied against property owned by any Insolvent Taxpayer (defined below) are

collectively referred to herein as the "Affected Bonds" and (b) the Special Assessments levied against any Insolvent Taxpayer's property and pledged under a Supplemental Indenture as security for the Affected Bonds are collectively referred to herein as the "Affected Special Assessments."

The Master Indenture will contain the following provisions which, pursuant to the Master Indenture, shall be applicable both before and after the commencement, whether voluntary or involuntary, of any case, proceeding or other action by or against any owner of any tax parcel subject to the Affected Special Assessments (herein, an "Insolvent Taxpayer") under any existing or future law of any jurisdiction relating to bankruptcy, insolvency, reorganization, assignment for the benefit of creditors, or relief of debtors (a "Proceeding"). For as long as any Affected Bonds remain Outstanding, in any Proceeding involving the District, any Insolvent Taxpayer, the Affected Bonds or the Affected Special Assessments, the District shall be obligated to act in accordance with any direction from the Trustee with regard to all matters directly or indirectly affecting at least three percent (3%) of the Outstanding aggregate principal amount of the Affected Bonds or for as long as any Affected Bonds remain Outstanding, in any proceeding involving the District, any Insolvent Taxpayer, the Affected Bonds or the Affected Special Assessments or the Trustee. The District has agreed in the Master Indenture that it shall not be a defense to a breach of the foregoing covenant that it has acted upon advice of counsel in not complying with this covenant.

In the Master Indenture, the District will acknowledge and agree that, although the Affected Bonds were issued by the District, the Owners of the Affected Bonds are categorically the party with the ultimate financial stake in the transaction and, consequently, the party with a vested and pecuniary interest in a Proceeding. In the event of any Proceeding involving any Insolvent Taxpayer: (a) the District will agree in the Master Indenture that it shall follow the direction of the Trustee in making any election, giving any consent, commencing any action or filing any motion, claim, obligation, notice or application or in taking any other action or position in any Proceeding or in any action related to a Proceeding that affects, either directly or indirectly, the Affected Special Assessments, the Affected Bonds or any rights of the Trustee under the Indenture; (b) the District will agree in the Master Indenture that it shall not make any election, give any consent, commence any action or file any motion, claim, obligation, notice or application or take any other action or position in any Proceeding or in any action related to a Proceeding that affects, either directly or indirectly, the Affected Special Assessments, the Affected Bonds or any rights of the Trustee under the Indenture that is inconsistent with any direction from the Trustee; (c) the Trustee shall have the right, but is not obligated to, (i) to the extent permitted by law, vote in any such Proceeding any and all claims of the District, or (ii) file any motion, pleading, plan or objection in any such Proceeding on behalf of the District, including without limitation, motions seeking relief from the automatic stay, dismissal of the Proceeding, valuation of the property belonging to the Insolvent Taxpayer, termination of exclusivity, and objections to disclosure statements, plans of liquidation or reorganization, and motions for use of cash collateral, seeking approval of sales or post-petition financing. If the Trustee chooses to exercise any such rights, the District shall be deemed to have appointed the Trustee as its agent and granted to the Trustee an irrevocable power of attorney coupled with an interest, and its proxy, for the purpose of exercising any and all rights and taking any and all actions available to the District in connection with any Proceeding of any Insolvent Taxpayer, including without limitation, the right to file and/or prosecute any claims, to propose and prosecute a plan, to vote to accept or reject a plan, and to make any election under Section 1111(b) of the Bankruptcy Code and (d) the District shall not challenge the validity or amount of any claim submitted in such Proceeding by the Trustee in good faith or any valuations of the lands owned by any Insolvent Taxpayer submitted by the Trustee in good faith in such Proceeding or take any other action in such Proceeding, which is adverse to Trustee's enforcement of the District claim and rights with respect to the Affected Special Assessments or receipt of adequate protection (as that term is defined in the Bankruptcy Code). Without limiting the generality of the foregoing, the District has agreed in the Master Indenture that the Trustee shall have the right (i) to file a proof of claim with respect to the Affected Special Assessments, (ii) to deliver to the District a copy thereof, together with evidence of the filing with the appropriate court

or other authority, and (iii) to defend any objection filed to said proof of claim. See "BONDOWNERS' RISKS – Bankruptcy Risks" herein.

Events of Default and Remedies

The Master Indenture provides that each of the following shall be an "Event of Default" under the Indenture, with respect to the Assessment Area One Bonds:

(a) if payment of any installment of interest on any Assessment Area One Bond is not made when it becomes due and payable; or

(b) if payment of the principal or Redemption Price of any Assessment Area One Bond is not made when it becomes due and payable at maturity or upon call or presentation for redemption; or

(c) if the District, for any reason, fails in, or is rendered incapable of, fulfilling its obligations under the Indenture or under the Act, as determined by a Majority Holder of the Assessment Area One Bonds; or

(d) if the District proposes or makes an assignment for the benefit of creditors or enters into a composition agreement with all or a material part of its creditors, or a trustee, receiver, executor, conservator, liquidator, sequestrator or other judicial representative, similar or dissimilar, is appointed for the District or any of its assets or revenues, or there is commenced any proceeding in liquidation, bankruptcy, reorganization, arrangement of debts, debtor rehabilitation, creditor adjustment or insolvency, local, state or federal, by or against the District and if such is not vacated, dismissed or stayed on appeal within ninety (90) days; or

(e) if the District defaults in the due and punctual performance of any other covenant in the Indenture or in any Assessment Area One Bond and such default continues for sixty (60) days after written notice requiring the same to be remedied shall have been given to the District by the Trustee, which may give such notice in its discretion and shall give such notice at the written request of the Majority Holder of the Outstanding Assessment Area One Bonds; provided, however, that if such performance requires work to be done, actions to be taken, or conditions to be remedied, which by their nature cannot reasonably be done, taken or remedied, as the case may be, within such sixty (60) day period, no Event of Default shall be deemed to have occurred or exist if, and so long as the District shall commence such performance within such sixty (60) day period and shall diligently and continuously prosecute the same to completion; or

(f) if at any time the amount in the Debt Service Reserve Fund or any account therein is less than the Reserve Requirement as a result of the Trustee withdrawing an amount therefrom to satisfy the Debt Service Requirement on the Assessment Area One Bonds and such amount has not been restored within [thirty (30)] days of such withdrawal; or

(g) if, at any time after eighteen months following issuance of the Assessment Area One Bonds, more than twenty percent (20%) of the "maintenance special assessments" levied by the District on District lands upon which the Assessment Area One Special Assessments are levied to secure the Assessment Area One Bonds pursuant to Section 190.021(3), Florida Statutes, as amended, and collected directly by the District have become due and payable and have not been paid, when due.

The Trustee shall not be required to rely on any official action, admission or declaration by the District before recognizing that an Event of Default under (c) above has occurred.

No Assessment Area One Bonds shall be subject to acceleration. Upon occurrence and continuance of an Event of Default with respect to the Assessment Area One Bonds, no optional redemption or extraordinary mandatory redemption of Assessment Area One Bonds pursuant to the Indenture shall occur unless all of the Assessment Area One Bonds will be redeemed or if 100% of the Holders of the Assessment Area One Bonds agree to such redemption.

If any Event of Default with respect to the Assessment Area One Bonds has occurred and is continuing, the Trustee, in its discretion may, and upon the written request of the Majority Holder of the Outstanding Assessment Area One Bonds and receipt of indemnity to its satisfaction shall:

- (a) by mandamus, or other suit, action or proceeding at law or in equity, enforce all rights of the Holders of the Assessment Area One Bonds, including, without limitation, the right to require the District to carry out any agreements with, or for the benefit of, the Bondholders of the Assessment Area One Bonds and to perform its or their duties under the Act;
- (b) bring suit upon the Assessment Area One Bonds;
- (c) by action or suit in equity require the District to account as if it were the trustee of an express trust for the Holders of the Assessment Area One Bonds;
- (d) by action or suit in equity enjoin any acts or things which may be unlawful or in violation of the rights of the Holders of the Assessment Area One Bonds; and
- (e) by other proceeding in law or equity, exercise all rights and remedies provided for by any other document or instrument securing the Assessment Area One Bonds.

If any proceeding taken by the Trustee on account of any Event of Default with respect to the Assessment Area One Bonds is discontinued or is determined adversely to the Trustee, then the District, the Trustee, the Paying Agent and the Bondholders of the Assessment Area One Bonds shall be restored to their former positions and rights under the Indenture as though no such proceeding had been taken.

Subject to the provisions of the Indenture, the Majority Holder of the Outstanding Assessment Area One Bonds then subject to remedial proceedings under the Master Indenture shall have the right to direct the method and place of conducting all remedial proceedings by the Trustee under the Indenture, provided that such directions shall not be otherwise than in accordance with law or the provisions of the Indenture.

ENFORCEMENT OF ASSESSMENT COLLECTIONS

General

The primary source of payment for the Assessment Area One Bonds is the collection of Assessment Area One Special Assessments imposed on District Lands in Assessment Area One specially benefited by the Assessment Area One Project pursuant to the Assessment Proceedings. See "ASSESSMENT METHODOLOGY AND THE ALLOCATION OF ASSESSMENTS" herein and "APPENDIX D: ASSESSMENT METHODOLOGY."

The imposition, levy, and collection of Assessment Area One Special Assessments must be done in compliance with the provisions of Florida law. Failure by the District, the Osceola County Tax Collector ("Tax Collector") or the Osceola County Property Appraiser ("Property Appraiser") to comply with such requirements could result in delay in the collection of, or the complete inability to collect, Assessment Area One Special Assessments during any year. Such delays in the collection of Assessment Area One Special

Assessments, or complete inability to collect the Assessment Area One Special Assessments, would have a material adverse effect on the ability of the District to make full or punctual payment of the debt service requirements on the Assessment Area One Bonds. See "BONDOWNERS' RISKS." To the extent that landowners fail to pay the Assessment Area One Special Assessments, delay payments, or are unable to pay the same, the successful pursuance of collection procedures available to the District is essential to continued payment of principal of and interest on the Assessment Area One Bonds.

For the Assessment Area One Special Assessments to be valid, the Assessment Area One Special Assessments must meet two requirements: (1) the benefit from the Assessment Area One Project to the lands subject to the Assessment Area One Special Assessments must exceed or equal the amount of the Assessment Area One Special Assessments, and (2) the Assessment Area One Special Assessments must be fairly and reasonably allocated across all such benefitted properties. The Certificate of the Methodology Consultant will certify that these requirements have been met with respect to the Assessment Area One Special Assessments.

Pursuant to the Act and the Assessment Proceedings, the District may collect the Assessment Area One Special Assessments through a variety of methods. Initially, and for undeveloped properties owned by the Developer, the District will directly issue annual bills to landowners requiring payment of the Assessment Area One Special Assessments and will enforce that bill through foreclosure proceedings. See "ASSESSMENT METHODOLOGY AND THE ALLOCATION OF ASSESSMENTS" and "APPENDIX D: ASSESSMENT METHODOLOGY." As lands are developed and platted, the Assessment Area One Special Assessments will be added to the County tax roll and collected pursuant to the Uniform Method. The following is a description of certain statutory provisions relating to each of these collection methods. Such description is not intended to be exhaustive and is qualified in its entirety by reference to such statutes.

Direct Billing & Foreclosure Procedure

As noted above, and pursuant to Chapters 170 and 190 of the Florida Statutes, the District may directly levy, collect and enforce the Assessment Area One Special Assessments. In this context, Section 170.10 of the Florida Statutes provides that upon the failure of any property owner to timely pay all or any part of the annual installment of principal and/or interest of a special assessment due, including the Assessment Area One Special Assessments, the whole assessment, with the interest and penalties thereon, shall immediately become due and payable and subject to foreclosure. Generally stated, the governing body of the entity levying the special assessment, in this case the District, may foreclose by commencing a foreclosure proceeding in the same manner as the foreclosure of a real estate mortgage, or, alternatively, by commencing an action under Chapter 173, Florida Statutes, which relates to foreclosure of municipal tax and special assessment liens. Such proceedings are in rem, meaning that the action would be brought against the land, and not against the landowner. In light of the one year tolling period required before the District may commence a foreclosure action under Chapter 173, Florida Statutes, it is likely the District would commence an action to foreclose in the same manner as the foreclosure of a real estate mortgage rather than proceeding under Chapter 173, Florida Statutes.

Enforcement of the obligation to pay Assessment Area One Special Assessments and the ability to foreclose the lien of such Assessment Area One Special Assessments upon the failure to pay such Assessment Area One Special Assessments may not be readily available or may be limited because enforcement is dependent upon judicial action which is often subject to discretion and delay. Additionally, there is no guarantee that there will be demand for any foreclosed lands sufficient to repay the Assessment Area One Special Assessments. See "BONDOWNERS' RISKS."

Uniform Method Procedure

Subject to certain conditions, and for developed lands (as described above), the District may alternatively elect to collect the Assessment Area One Special Assessments using the Uniform Method. The Uniform Method of collection is available only in the event the District complies with statutory and regulatory requirements and enters into agreements with the Tax Collector and Property Appraiser providing for the Assessment Area One Special Assessments to be levied and then collected in this manner.

If the Uniform Method of collection is used, the Assessment Area One Special Assessments will be collected together with the County, school, special district, and other ad valorem taxes and non-ad valorem assessments (together, "Taxes and Assessments"), all of which will appear on the tax bill (also referred to as a "tax notice") issued to each landowner in the District. The statutes relating to enforcement of Taxes and Assessments provide that such Taxes and Assessments become due and payable on November 1 of the year when assessed, or as soon thereafter as the certified tax roll is received by the Tax Collector, and constitute a lien upon the land from January 1 of such year until paid or barred by operation of law. Such taxes and assessments – including the Assessment Area One Special Assessments – are to be billed, and landowners in the District are required to pay, all Taxes and Assessments without preference in payment of any particular increment of the tax bill, such as the increment owing for the Assessment Area One Special Assessments.

All Taxes and Assessments are payable at one time, except for partial payment schedules as may be provided by Florida law such as Sections 197.374 and 197.222, Florida Statutes. Partial payments made pursuant to Sections 197.374 and 197.222, Florida Statutes, are distributed in equal proportion to all taxing districts and levying authorities applicable to that account. If a taxpayer does not make complete payment of the total amount, he or she cannot designate specific line items on his or her tax bill as deemed paid in full. Therefore, in the event the Assessment Area One Special Assessments are to be collected pursuant to the Uniform Method, any failure to pay any one line item, would cause the Assessment Area One Special Assessments to not be collected to that extent, which could have a significant adverse effect on the ability of the District to make full or punctual payment of the debt service requirements on the Assessment Area One Bonds.

Under the Uniform Method, if the Assessment Area One Special Assessments are paid during November when due or during the following three months, the taxpayer is granted a variable discount equal to 4% in November and decreasing one percentage point per month to 1% in February. All unpaid Taxes and Assessments become delinquent on April 1 of the year following assessment.

The Tax Collector is required to collect the Taxes and Assessments on the tax bill prior to April 1 and, after that date, to institute statutory procedures upon delinquency to collect such Taxes and Assessments through the sale of "tax certificates," as discussed below. Delay in the mailing of tax notices to taxpayers may result in a delay throughout this process. Neither the District nor the Underwriter can give any assurance to the holders of the Assessment Area One Bonds (1) that the past experience of the Tax Collector with regard to tax and special assessment delinquencies is applicable in any way to the Assessment Area One Special Assessments, (2) that future landowners and taxpayers in the District will pay such Assessment Area One Special Assessments, (3) that a market may exist in the future for tax certificates in the event of sale of such certificates for taxable units within the District, and (4) that the eventual sale of tax certificates for real property within the District, if any, will be for an amount sufficient to pay amounts due under the Assessment Proceedings to discharge the lien of the Assessment Area One Special Assessments and all other liens that are coequal therewith.

Collection of delinquent Assessment Area One Special Assessments under the Uniform Method is, in essence, based upon the sale by the Tax Collector of "tax certificates" and remittance of the proceeds of

such sale to the District for payment of the Assessment Area One Special Assessments due. Prior to the sale of tax certificates, the landowner may bring current the delinquent Taxes and Assessments and cancel the tax certificate process by paying the total amount of delinquent Taxes and Assessments plus all applicable interest, costs and charges. If the landowner does not act, the Tax Collector is required to attempt to sell tax certificates by public bid to the person who pays the delinquent Taxes and Assessments owing, and any applicable interest, costs and charges, and who accepts the lowest interest rate per annum to be borne by the certificates (but not more than 18%).

If there are no bidders, the tax certificate is issued to the County. The County is to hold, but not pay for, the tax certificate with respect to the property, bearing interest at the maximum legal rate of interest, which is currently 18%. The Tax Collector does not collect any money if tax certificates are issued, or struck off, to the County. The County may sell such certificates to the public at any time after issuance, but before a tax deed application is made, at the face amount thereof plus interest at the rate of not more than 18% per annum, costs and charges. Proceeds from the sale of tax certificates are required to be used to pay Taxes and Assessments (including the Assessment Area One Special Assessments), interest, costs and charges on the real property described in the certificate.

Unless full payment for a tax deed is made to the clerk of court, including documentary stamps and recording fees, any tax certificate in the hands of a person other than the County may be redeemed and canceled, in whole or in part (under certain circumstances), at any time before a tax deed is issued, and at a price equal to the face amount of the certificate or portion thereof together with all interest, costs, and charges due. Regardless of the interest rate actually borne by the certificates, persons redeeming tax certificates must pay a minimum interest rate of 5%, unless the rate borne by the certificates is zero percent. The proceeds of such a redemption are paid to the Tax Collector who transmits to the holder of the tax certificate such proceeds less service charges, and the certificate is canceled. Redemption of tax certificates held by the County is effected by purchase of such certificates from the County, as described above.

For any holder other than the County, a tax certificate expires seven years after the date of issuance, if a tax deed has not been applied for, and no other administrative or legal proceeding, including a bankruptcy, has existed of record, the tax certificate is null and void. After an initial period ending two years from April 1 of the year of issuance of a certificate, during which period actions against the land are held in abeyance to allow for sales and redemptions of tax certificates, and before the expiration of seven years from the date of issuance, the holder of a certificate may apply for a tax deed to the subject land. The applicant is required to pay to the Tax Collector at the time of application all amounts required to redeem or purchase all other outstanding tax certificates covering the land, plus interest, any omitted taxes or delinquent taxes and interest, and current taxes, if due (as well as any costs of resale, if applicable). If the County holds a tax certificate on property valued at \$5,000 or more and has not succeeded in selling it, the County must apply for a tax deed two years after April 1 of the year of issuance of the certificate or as soon thereafter as is reasonable. The County pays costs and fees to the Tax Collector but not any amount to redeem any other outstanding certificates covering the land. Thereafter, the property is advertised for public sale.

In any such public sale conducted by the Clerk of the Circuit Court, the private holder of the tax certificate who is seeking a tax deed for non-homestead property is deemed to submit a minimum bid equal to the amount required to redeem the tax certificate, charges for the cost of sale, including costs incurred for the service of notice required by statute, redemption of other tax certificates on the land, and all other costs to the applicant for the tax deed, plus interest thereon. In the case of homestead property, the minimum bid is also deemed to include, in addition to the amount of money required for the minimum bid on non-homestead property, an amount equal to one-half of the latest assessed value of the homestead. If there are no higher bids, the holder receives title to the land, and the amounts paid for the certificate and in applying for a tax deed are credited toward the purchase price. The holder is also responsible for payment of any

amounts included in the bid not already paid, including but not limited to, documentary stamp tax, recording fees, and, if property is homestead property, the moneys to cover the one-half value of the homestead. If there are other bids, the holder may enter the bidding. The highest bidder is awarded title to the land. The portion of proceeds of such sale needed to redeem the tax certificate, together with all subsequent unpaid taxes plus the costs and expenses of the application for deed, with interest on the total of such sums, are forwarded to the holder thereof or credited to such holder if such holder is the successful bidder. Excess proceeds are distributed first to satisfy governmental liens against the land and then to the former title holder of the property (less service charges), lienholder of record, mortgagees of record, vendees of recorded contracts for deeds, and other lienholders and any other person to whom the land was last assessed on the tax roll for the year in which the land was assessed, all as their interest may appear. If the property is purchased for an amount in excess of the statutory bid of the certificate holder, but such excess is not sufficient to pay all governmental liens of record, the excess shall be paid to each governmental unit pro rata.

Except for certain governmental liens and certain restrictive covenants and restrictions, no right, interest, restriction or other covenant survives the issuance of a tax deed. Thus, for example, outstanding mortgages on property subject to a tax deed would be extinguished.

If there are no bidders at the public sale, the clerk shall enter the land on a list entitled "lands available for taxes" and shall immediately notify the County that the property is available. At any time within ninety (90) days from the date the property is placed on the list, the County may purchase the land for the opening bid, or may waive its rights to purchase the property. Thereafter, and without further notice or advertising, any person, the County or any other governmental unit may purchase the land by paying the amount of the opening bid. Ad valorem taxes and non-ad valorem assessments accruing after the date of public sale do not require repetition of the bidding process but are added to the minimum bid. Three years from the date the property was offered for sale, unsold lands escheat to the County in which they are located, free and clear, and all tax certificates and liens against the property are canceled and a deed is executed vesting title in the governing board of such County.

There can be no guarantee that the Uniform Method will result in the payment of Assessment Area One Special Assessments. For example, the demand for tax certificates is dependent upon various factors, which include the rate of interest that can be earned by ownership of such certificates and the underlying value of the land that is the subject of such certificates and which may be subject to sale at the demand of the certificate holder. Therefore, the underlying market value of the property within the District may affect the demand for certificates and the successful collection of the Assessment Area One Special Assessments, which are the primary source of payment of the Assessment Area One Bonds. Additionally, legal proceedings under Federal bankruptcy law brought by or against a landowner who has not yet paid his or her property taxes or assessments would likely result in a delay in the sale of tax certificates. See "BONDHOLDERS' RISKS."

BONDOWNERS' RISKS

There are certain risks inherent in an investment in bonds issued by a public authority or governmental body in the State and secured by special assessments. Certain of these risks are described in other sections of this Limited Offering Memorandum. Certain additional risks are associated with the Assessment Area One Bonds offered hereby and are set forth below. Prospective investors in the Assessment Area One Bonds should have such knowledge and experience in financial and business matters to be capable of evaluating the merits and risks of an investment in the Assessment Area One Bonds and have the ability to bear the economic risks of such prospective investment, including a complete loss of such investment. This section does not purport to summarize all risks that may be associated with purchasing or owning the Assessment Area One Bonds, and prospective purchasers are advised to read this

Limited Offering Memorandum in its entirety for a more complete description of investment considerations relating to the Assessment Area One Bonds.

Concentration of Land Ownership

As of the date hereof, the Developer owns all of the assessable lands within Assessment Area One, which are the lands that will be subject to the Assessment Area One Special Assessments securing the Assessment Area One Bonds. Payment of the Assessment Area One Special Assessments is primarily dependent upon their timely payment by the Developer and the other future landowners in Assessment Area One. Non-payment of the Assessment Area One Special Assessments by any of the landowners could have a substantial adverse impact upon the District's ability to pay debt service on the Assessment Area One Bonds. See "THE DEVELOPER" and "SECURITY FOR AND SOURCE OF PAYMENT OF THE ASSESSMENT AREA ONE BONDS" herein.

Bankruptcy and Related Risks

In the event of the institution of bankruptcy or similar proceedings with respect to the Developer or any other owner of benefited property, delays could occur in the payment of debt service on the Assessment Area One Bonds, as such bankruptcy could negatively impact the ability of: (i) the Developer and any other landowner to pay the Assessment Area One Special Assessments; (ii) the Tax Collector to sell tax certificates in relation to such property with respect to the Assessment Area One Special Assessments being collected pursuant to the Uniform Method; and (iii) the District to foreclose the lien of the Assessment Area One Special Assessments not being collected pursuant to the Uniform Method. In addition, the remedies available to the Owners of the Assessment Area One Bonds under the Indenture are in many respects dependent upon judicial actions which are often subject to discretion and delay. Under existing constitutional and statutory law and judicial decisions, the remedies specified by federal, state and local law and in the Indenture and the Assessment Area One Bonds, including, without limitation, enforcement of the obligation to pay Assessment Area One Special Assessments and the ability of the District to foreclose the lien of the Assessment Area One Special Assessments if not being collected pursuant to the Uniform Method, may not be readily available or may be limited. The various legal opinions to be delivered concurrently with the delivery of the Assessment Area One Bonds (including Bond Counsel's approving opinion) will be qualified as to the enforceability of the various legal instruments by limitations imposed by bankruptcy, reorganization, insolvency or other similar laws affecting the rights of creditors enacted before or after such delivery. The inability, either partially or fully, to enforce remedies available with respect to the Assessment Area One Bonds could have a material adverse impact on the interest of the Owners thereof.

A 2011 bankruptcy court decision in Florida held that the governing body of a community development district, and not the bondholders or indenture trustee, was the creditor of the landowners/debtors in bankruptcy with respect to claims for special assessments, and thus only the district could vote to approve or disapprove a reorganization plan submitted by the debtors in the case. The district voted in favor of the plan. The governing body of the district was at that time elected by the landowners rather than qualified electors. Under the reorganization plan that was approved, a two-year moratorium was placed on the debtor landowners' payment of special assessments. As a result of this non-payment of assessments, debt service payments on the district's bonds were delayed for two years or longer. The Master Indenture provides for the delegation of certain rights from the District to the Trustee in the event of a bankruptcy or similar proceeding with respect to an "Insolvent Taxpayer" (as previously defined). See "SECURITY FOR AND SOURCE OF PAYMENT OF THE ASSESSMENT AREA ONE BONDS – Indenture Provisions Relating to Bankruptcy or Insolvency of a Landowner" herein. The District cannot express any view whether such delegation would be enforceable.

Assessment Area One Special Assessments Are Non-Recourse

The principal security for the payment of the principal and interest on the Assessment Area One Bonds is the timely collection of the Assessment Area One Special Assessments. The Assessment Area One Special Assessments do not constitute a personal indebtedness of the landowners of the land subject thereto, but are secured by a lien on such land. There is no assurance that the Developer or subsequent landowners will be able to pay the Assessment Area One Special Assessments or that they will pay such Assessment Area One Special Assessments even though financially able to do so. Neither the Developer nor any other subsequent landowners have any personal obligation to pay the Assessment Area One Special Assessments. Neither the Developer nor any subsequent landowners are guarantors of payment of any Assessment Area One Special Assessments, and the recourse for the failure of the Developer or any subsequent landowner to pay the Assessment Area One Special Assessments is limited to the collection proceedings against the land subject to such unpaid Assessment Area One Special Assessments, as described herein. Therefore the likelihood of collection of the Assessment Area One Special Assessments may ultimately depend on the market value of the land subject to the Assessment Area One Special Assessments. While the ability of the Developer or subsequent landowners to pay the Assessment Area One Special Assessments is a relevant factor, the willingness of the Developer or subsequent landowners to pay the Assessment Area One Special Assessments, which may also be affected by the value of the land subject to the Assessment Area One Special Assessments, is also an important factor in the collection of Assessment Area One Special Assessments. The failure of the Developer or subsequent landowners to pay the Assessment Area One Special Assessments could render the District unable to collect delinquent Assessment Area One Special Assessments and provided such delinquencies are significant, could negatively impact the ability of the District to make the full or punctual payment of debt service on the Assessment Area One Bonds.

Regulatory and Environmental Risks

The development of Assessment Area One is subject to comprehensive federal, state and local regulations and future changes to such regulations. Approval is required from various public agencies in connection with, among other things, the design, nature and extent of planned improvements, both public and private, and construction of the infrastructure in accordance with applicable zoning, land use and environmental regulations. Although all such approvals required to date have been received and any further approvals are anticipated to be received as needed, failure to obtain any such approvals in a timely manner could delay or adversely affect the completion of the development of the District Lands. See "THE DEVELOPMENT – Development Approvals" herein for more information.

The value of the land within the District, the success of the Development, the development of Assessment Area One and the likelihood of timely payment of principal and interest on the Assessment Area One Bonds could be affected by environmental factors with respect to the land in the District. Should the land be contaminated by hazardous materials, this could materially and adversely affect the value of the land in the District, which could materially and adversely affect the success of the development of the lands within Assessment Area One and the likelihood of the timely payment of the Assessment Area One Bonds. The District has not performed, nor has the District requested that there be performed on its behalf, any independent assessment of the environmental conditions within the District. See "THE DEVELOPMENT – Environmental" for information on environmental site assessments obtained or received. Such information is being provided solely for informational purposes, and nothing herein or in such assessments grants any legal rights or remedies in favor of the Assessment Area One Bondholders in the event any recognized environmental conditions are later found to be present on District Lands. Nevertheless, it is possible that hazardous environmental conditions could exist within the District or in the vicinity of the District and that such conditions could have a material and adverse impact upon the value of the benefited lands within Assessment Area One. No assurance can be given that unknown hazardous materials, protected

animals or vegetative species, etc., do not currently exist or may not develop in the future, whether originating within the District or from surrounding property, and what effect such may have on the development or sale of the lands in Assessment Area One.

The value of the lands subject to the Assessment Area One Special Assessments could also be adversely impacted by flooding or wind damage caused by hurricanes, tropical storms, or other catastrophic events. In addition to potential damage or destruction to any existing development or construction in or near the District, such catastrophic events could potentially render the District Lands unable to support future development. The occurrence of any such events could materially adversely impact the District's ability to pay principal and interest on the Assessment Area One Bonds. The Assessment Area One Bonds are not insured, and the District's casualty insurance policies do not insure against losses incurred on private lands within its boundaries.

Economic Conditions and Changes in Development Plans

The successful development of Assessment Area One and the sale of residential units therein, once such homes are built, may be affected by unforeseen changes in general economic conditions, fluctuations in the real estate market and other factors beyond the control of the Developer. Moreover, the Developer has the right to modify or change plans for development of Assessment Area One from time to time, including, without limitation, land use changes, changes in the overall land and phasing plans, and changes to the type, mix, size and number of units to be developed, and may seek in the future, in accordance with and subject to the provisions of the Act, to contract or expand the boundaries of the District.

Other Taxes and Assessments

The willingness and/or ability of an owner of benefited land to pay the Assessment Area One Special Assessments could be affected by the existence of other taxes and assessments imposed upon such property by the District, the County or any other local special purpose or general purpose governmental entities. County, school, special district taxes and special assessments, and voter-approved ad valorem taxes levied to pay principal of and interest on debt, including the Assessment Area One Special Assessments, collected pursuant to the Uniform Method are payable at one time. Public entities whose boundaries overlap those of the District could, without the consent of the owners of the land within the District, impose additional taxes on the property within the District. The District anticipates imposing operation and maintenance assessments encumbering the same property encumbered by the Assessment Area One Special Assessments. In addition, lands within the District may also be subject to assessments by property owners' and homeowners' associations. See "THE DEVELOPMENT – Taxes, Fees and Assessments" herein for additional information.

Under Florida law, a landowner may contest the assessed valuation determined for its property that forms the basis of ad-valorem taxes such landowner must pay. During this contest period, the sale of a tax certificate under the Uniform Method will be suspended. If the Assessment Area One Special Assessments are being collected along with ad valorem taxes pursuant to the Uniform Method, tax certificates will not be sold with respect to such Assessment Area One Special Assessment, even though the landowner is not contesting the amount of the Assessment Area One Special Assessment. However, Section 194.014, Florida Statutes, requires taxpayers challenging the assessed value of their property to pay all non-ad valorem assessments and at least 75% of their ad valorem taxes before they become delinquent. Likewise, taxpayers who challenge the denial of an exemption or classification or a determination that their improvements were substantially complete must pay all non-ad valorem assessments and the amount of ad valorem taxes that they admit in good faith to be owing. If a taxpayer fails to pay property taxes as set forth above, the Value Adjustment Board considering the taxpayer's challenge is required to deny such petition by written decision by April 20 of such year.

Limited Secondary Market for Assessment Area One Bonds

The Assessment Area One Bonds may not constitute a liquid investment, and there is no assurance that a liquid secondary market will exist for the Assessment Area One Bonds in the event an Owner thereof determines to solicit purchasers for the Assessment Area One Bonds. Even if a liquid secondary market exists, there can be no assurance as to the price for which the Assessment Area One Bonds may be sold. Such price may be lower than that paid by the current Owners of the Assessment Area One Bonds, depending on the progress of development of the Development and the lands within Assessment Area One, as applicable, existing real estate and financial market conditions and other factors.

Inadequacy of Reserve Account

Some of the risk factors discussed herein, which, if materialized, would result in a delay in the collection of the Assessment Area One Special Assessments, may not adversely affect the timely payment of debt service on the Assessment Area One Bonds because of the Assessment Area One Reserve Account. The ability of the Assessment Area One Reserve Account to fund deficiencies caused by delinquencies in the Assessment Area One Special Assessments is dependent on the amount, duration and frequency of such deficiencies. Moneys on deposit in the Assessment Area One Reserve Account may be invested in certain obligations permitted under the Indenture. Fluctuations in interest rates and other market factors could affect the amount of moneys in such Assessment Area One Reserve Account to make up deficiencies. If the District has difficulty in collecting the Assessment Area One Special Assessments, the Assessment Area One Reserve Account would be rapidly depleted and the ability of the District to pay debt service on the Assessment Area One Bonds could be materially adversely affected. In addition, during an Event of Default under the Indenture, the Trustee may withdraw moneys from the Assessment Area One Reserve Account and such other Funds, Accounts and subaccounts created under the Indenture to pay its extraordinary fees and expenses incurred in connection with such Event of Default. If in fact the Assessment Area One Reserve Account is accessed for any purpose, the District does not have a designated revenue source for replenishing such account. Moreover, the District may not be permitted to re-assess real property then burdened by the Assessment Area One Special Assessments in order to provide for the replenishment of the Assessment Area One Reserve Account. See "SECURITY FOR AND SOURCE OF PAYMENT OF THE ASSESSMENT AREA ONE BONDS – Reserve Account" herein for more information about the Assessment Area One Reserve Account.

Legal Delays

If the District should commence a foreclosure action against a landowner for nonpayment of Assessment Area One Special Assessments that are not being collected pursuant to the Uniform Method, such landowner and/or its mortgagee(s) may raise affirmative defenses to such foreclosure action. Although the District expects that such affirmative defenses would likely be proven to be without merit, they could result in delays in completing the foreclosure action. In addition, the District is required under the Indenture to fund the costs of such foreclosure. It is possible that the District will not have sufficient funds and will be compelled to request the Holders of the Assessment Area One Bonds to allow funds on deposit under the Indenture to be used to pay the costs of the foreclosure action. Under the Code (as defined herein), there are limitations on the amounts of proceeds from the Assessment Area One Bonds that can be used for such purpose.

IRS Examination and Audit Risk

The Internal Revenue Service (the "IRS") routinely examines bonds issued by state and local governments, including bonds issued by community development districts. In 2016, the IRS concluded its lengthy examination of certain issues of bonds (for purposes of this subsection, the "Audited Bonds") issued

by Village Center Community Development District (the "Village Center CDD"). During the course of the audit of the Audited Bonds, Village Center CDD received a ruling dated May 30, 2013, in the form of a non-precedential technical advice memorandum ("TAM") concluding that Village Center CDD is not a political subdivision for purposes of Section 103(a) of the Code because Village Center CDD was organized and operated to perpetuate private control and avoid indefinitely responsibility to an electorate, either directly or through another elected state or local government body. Such a conclusion could lead to the further conclusion that the interest on the Audited Bonds was not excludable from gross income of the owners of such bonds for federal income tax purposes. Village Center CDD received a second TAM dated June 17, 2015, which granted relief to Village Center CDD from retroactive application of the IRS's conclusion regarding its failure to qualify as a political subdivision. Prior to the conclusion of the audits, the Audited Bonds were all refunded with taxable bonds. The audit of the Audited Bonds that were issued for utility improvements were closed without change to the tax exempt status of those Audited Bonds on April 25, 2016, and the audit of the remainder of the Audited Bonds (which funded recreational amenity acquisitions from entities related to the principal landowner in the Village Center CDD) was closed on July 14, 2016, without the IRS making a final determination that the interest on the Audited Bonds in question was required to be included in gross income. However, the IRS letter to the Village Center CDD with respect to this second set of Audited Bonds noted that the IRS found that the Village Center CDD was not a "proper issuer of tax-exempt bonds" and that those Audited Bonds were private-activity bonds that did not fall in any of the categories that qualify for tax-exemption. Although the TAMs and the letters to the Village Center CDD from the IRS referred to above are addressed to, and binding only on, the IRS and Village Center CDD in connection with the Audited Bonds, they reflect the audit position of the IRS, and there can be no assurance that the IRS would not commence additional audits of bonds issued by other community development districts raising issues similar to the issues raised in the case of the Audited Bonds based on the analysis set forth in the first TAM or on the related concerns addressed in the July 14, 2016 letter to the Village Center CDD.

On February 23, 2016, the IRS published proposed regulations designed to provide prospective guidance with respect to potential private business control of issuers by providing a new definition of political subdivision for purposes of determining whether an entity is an appropriate issuer of bonds the interest on which is excluded from gross income for federal tax purposes. The proposed regulations required that a political subdivision (i) have the power to exercise at least one sovereign power, (ii) be formed and operated for a governmental purpose, and (iii) have a governing body controlled by or have significant uses of its funds or assets otherwise controlled by a government unit with all three sovereign powers or by an electorate that is not controlled by an unreasonably small number of unrelated electors. On October 4, 2017, the Treasury Department ("Treasury") announced that it would withdraw the proposed regulations, stating that, "while Treasury and the IRS continue to study the legal issues relating to political subdivisions, Treasury and the IRS currently believe that these proposed regulations should be withdrawn in their entirety, and plan to publish a withdrawal of the proposed regulations shortly in the Federal Register. Treasury and the IRS may propose more targeted guidance in the future after further study of the relevant legal issues." Notice of withdrawal of the proposed regulations was published in the Federal Register on October 20, 2017.

It has been reported that the IRS has closed audits of other community development districts in the State with no change to such districts' bonds' tax-exempt status, but has advised such districts that such districts must have public electors within the timeframe established by the applicable state law or their bonds may be determined to be taxable retroactive to the date of issuance. Pursuant to the Act, general elections are not held until the later of six years from the date of establishment of the community development district or the time at which there are at least 250 qualified electors in the district. The District, unlike Village Center CDD, was formed with the intent that it will contain a sufficient number of residents to allow for a transition to control by a general electorate. Currently, all of the members of the Board of the District were elected by the landowners and none were elected by qualified electors. The Developer will

certify as to its expectations as to the timing of the transition of control of the Board of the District to qualified electors pursuant to the Act. Such certification by the Developer does not ensure that such certification shall be determinative of, or may influence the outcome of any audit by the IRS, or any appeal from such audit, that may result in an adverse ruling that the District is not a political subdivision for purposes of Section 103(a) of the Code. Further, there can be no assurance that an audit by the IRS of the Assessment Area One Bonds will not be commenced. The District has no reason to believe that any such audit will be commenced, or that any such audit, if commenced, would result in a conclusion of noncompliance with any applicable State or federal law.

Owners of the Assessment Area One Bonds are advised that, if the IRS does audit the Assessment Area One Bonds, under its current procedures, at least during the early stages of an audit, the IRS will treat the District as the taxpayer, and the Owners of the Assessment Area One Bonds may have limited rights to participate in those proceedings. The commencement of such an audit could adversely affect the market value and liquidity of the Assessment Area One Bonds until the audit is concluded, regardless of the ultimate outcome. In addition, in the event of an adverse determination by the IRS with respect to the tax-exempt status of interest on the Assessment Area One Bonds, it is unlikely the District will have available revenues to enable it to contest such determination or enter into a voluntary financial settlement with the IRS. Further, an adverse determination by the IRS with respect to the tax-exempt status of interest on the Assessment Area One Bonds would adversely affect the availability of any secondary market for the Assessment Area One Bonds. Should interest on the Assessment Area One Bonds become includable in gross income for federal income tax purposes, not only will Owners of Assessment Area One Bonds be required to pay income taxes on the interest received on such Assessment Area One Bonds and related penalties, but because the interest rate on such Assessment Area One Bonds will not be adequate to compensate Owners of the Assessment Area One Bonds for the income taxes due on such interest, the value of the Assessment Area One Bonds may decline.

THE INDENTURE DOES NOT PROVIDE FOR ANY ADJUSTMENT IN THE INTEREST RATES ON THE ASSESSMENT AREA ONE BONDS IN THE EVENT OF AN ADVERSE DETERMINATION BY THE IRS WITH RESPECT TO THE TAX-EXEMPT STATUS OF INTEREST ON THE ASSESSMENT AREA ONE BONDS. PROSPECTIVE PURCHASERS OF THE ASSESSMENT AREA ONE BONDS SHOULD EVALUATE WHETHER THEY CAN OWN THE ASSESSMENT AREA ONE BONDS IN THE EVENT THAT THE INTEREST ON THE ASSESSMENT AREA ONE BONDS BECOMES TAXABLE AND/OR THE DISTRICT IS EVER DETERMINED TO NOT BE A POLITICAL SUBDIVISION FOR PURPOSES OF THE CODE AND/OR SECURITIES ACT (AS HEREINAFTER DEFINED).

Loss of Exemption from Securities Registration

The Assessment Area One Bonds have not been and will not be registered under the Securities Act of 1933, as amended (the "Securities Act"), or any state securities laws, because of the exemption for securities issued by political subdivisions. It is possible that federal or state regulatory authorities could in the future determine that the District is not a political subdivision for purposes of federal and state securities laws, including without limitation as the result of a determination by the IRS, judicial or otherwise, of the District's status for purposes of the Code. In such event, the District and purchasers of Assessment Area One Bonds may not be able to rely on the exemption from registration under the Securities Act relating to securities issued by political subdivisions. In that event, the Owners of the Assessment Area One Bonds would need to ensure that subsequent transfers of the Assessment Area One Bonds are made pursuant to a transaction that is not subject to the registration requirements of the Securities Act and applicable state securities laws.

Federal Tax Reform

Various legislative proposals are mentioned from time to time by members of Congress of the United States of America and others concerning reform of the internal revenue (tax) laws of the United States. In addition, the IRS may, in the future, issue rulings that have the effect of challenging the interpretation of existing tax laws. Certain of these proposals and interpretations, if implemented or upheld, could have the effect of diminishing the value of obligations of states and their political subdivisions, such as the Assessment Area One Bonds, by eliminating or changing the tax-exempt status of interest on such bonds. Whether any such proposals will ultimately become or be upheld as law, and if so, the effect such proposals could have upon the value of bonds such as the Assessment Area One Bonds cannot be predicted. However, it is possible that any such law or interpretation could have a material and adverse effect upon the availability of a liquid secondary market and/or the value of the Assessment Area One Bonds. Prospective purchasers of the Assessment Area One Bonds should consult their tax advisors as to the impact of any proposed or pending legislation. See also "TAX MATTERS" herein.

State Tax Reform

It is impossible to predict what new proposals may be presented regarding tax reform and/or community development districts during upcoming legislative sessions, whether such new proposals or any previous proposals regarding the same will be adopted by the Florida Senate and House of Representatives and signed by the Governor, and, if adopted, the form thereof. On October 31, 2014, the Auditor General of the State released a 31-page report which requests legislative action to establish parameters on the amount of bonds a community development district may issue and provide additional oversight for community development district bonds. This report renewed requests made by the Auditor General in 2011 that led to the Governor of the State issuing an Executive Order on January 11, 2012 (the "Executive Order") directing the Office of Policy and Budget in the Executive Office of the Governor ("OPB") to examine the role of special districts in the State. As of the date hereof, the OPB has not made any recommendations pursuant to the Executive Order nor has the Florida legislature passed any related legislation. It is impossible to predict with certainty the impact that any existing or future legislation will or may have on the security for the Assessment Area One Bonds. It should be noted that Section 190.16(14) of the Act provides in pertinent part that "The state pledges to the holders of any bonds issued under the Act that it will not limit or alter the rights of the district to levy and collect the ... assessments... and to fulfill the terms of any agreement made with the holders of such bonds ... and that it will not impair the rights or remedies of such holders."

Insufficient Resources or Other Factors Causing Failure to Complete Development

The cost to finish the Assessment Area One Project and the development of Assessment Area One will exceed the net proceeds from the Assessment Area One Bonds. There can be no assurance, in the event the District does not have sufficient moneys on hand to complete the Assessment Area One Project, that the District will be able to raise, through the issuance of additional bonds or otherwise, the moneys necessary to complete the Assessment Area One Project and the development of Assessment Area One. Further, the Indenture sets forth certain limitations on the issuance of additional bonds. See "SECURITY FOR AND SOURCE OF PAYMENT OF THE ASSESSMENT AREA ONE BONDS – Additional Bonds" for more information.

Although the Developer will agree to fund or cause to be funded the completion of the Assessment Area One Project regardless of the insufficiency of proceeds from the Assessment Area One Bonds and will enter into a completion agreement with the District as evidence thereof, there can be no assurance that the Developer will have sufficient resources to do so. Such obligation of the Developer is an unsecured obligation. See "THE DEVELOPER" herein for more information.

There are no assurances that the Assessment Area One Project and any other remaining development work associated with Assessment Area One will be completed. Further, even if development of Assessment Area One is completed, there are no assurances that homes will be constructed and sold within Assessment Area One. See "THE DEVELOPER" herein for more information.

Pandemics and Other Public Health Emergencies

The COVID-19 pandemic severely impacted global financial markets, unemployment levels and commerce generally. It is possible that, in the future, the spread of epidemic or pandemic diseases and/or government health and public safety restrictions imposed in response thereto could adversely impact the District, the Developer, the timely and successful completion of the Development and the construction and sale to purchasers of residential units therein. Such impacts could include delays in obtaining development approvals, construction delays, supply chain delays, or increased costs. See also "Economic Conditions and Changes in Development Plans" and "Insufficient Resources or Other Factors Causing Failure to Complete Development" herein.

Cybersecurity

The District relies on a technological environment to conduct its operations. The District, its agents and other third parties the District does business with or otherwise relies upon are subject to cyber threats including, but not limited to, hacking, viruses, malware and other attacks on computer and other sensitive digital networks and systems. Entities or individuals may attempt to gain unauthorized access to such parties' digital systems for the purposes of misappropriating assets or information or causing operational disruption and damage. No assurances can be given that any such attack(s) will not materially impact the operations or finances of the District, which could impact the timely payment of debt service on the Assessment Area One Bonds.

Prepayment and Redemption Risk

In addition to being subject to optional and mandatory sinking fund redemptions, the Assessment Area One Bonds are subject to extraordinary mandatory redemption, including, without limitation, as a result of prepayments of the Assessment Area One Special Assessments by the Developer or subsequent owners of the property within Assessment Area One. Any such redemptions of the Assessment Area One Bonds would be at the principal amount of such Assessment Area One Bonds being redeemed plus accrued interest to the date of redemption. In such event, owners of the Assessment Area One Bonds may not realize their anticipated rate of return on the Assessment Area One Bonds and owners of any Premium Bonds (as defined herein) may receive less than the price they paid for the Assessment Area One Bonds. See "DESCRIPTION OF THE ASSESSMENT AREA ONE BONDS – Redemption Provisions," "– Purchase of Assessment Area One Bonds" and "SECURITY FOR AND SOURCE OF PAYMENT OF THE ASSESSMENT AREA ONE BONDS – Prepayment of Assessment Area One Special Assessments" herein for more information.

Payment of Assessment Area One Special Assessments after Bank Foreclosure

In the event a bank forecloses on property because of a default on a mortgage in favor of such bank on any of the assessable lands within the District, and then the bank itself fails, the Federal Deposit Insurance Corporation (the "FDIC"), as receiver, will then become the fee owner of such property. In such event, the FDIC will not, pursuant to its own rules and regulations, likely be liable to pay the Assessment Area One Special Assessments levied on such property. In addition, the District would require the consent of the FDIC prior to commencing a foreclosure action.

[Remainder of page intentionally left blank.]

ESTIMATED SOURCES AND USES OF FUNDS

The table that follows summarizes the estimated sources and uses of proceeds of the Assessment Area One Bonds:

	Total Assessment Area One Bonds
Sources of Funds:	
Principal Amount	\$ _____
[Plus/Less Original Issue Premium/Discount]	_____
Total Sources	\$ _____
Use of Funds:	
Deposit to Assessment Area One Acquisition and Construction Account	\$ _____
Deposit to Assessment Area One Reserve Account	_____
Deposit to Assessment Area One Interest Account ⁽¹⁾	_____
Costs of Issuance ⁽²⁾	_____
Total Uses	\$ _____

(1) Includes Capitalized Interest through [____]1, 20__].

(2) Costs of issuance include, without limitation, underwriter's discount, legal fees and other costs associated with the issuance of the Assessment Area One Bonds.

[Remainder of page intentionally left blank]

DEBT SERVICE REQUIREMENTS

The following table sets forth the scheduled debt service on the Assessment Area One Bonds:

<u>Period Ending</u> <u>November 1</u>	<u>Assessment Area One Bonds</u>		<u>Total Debt</u>
	<u>Principal</u>	<u>Interest</u>	<u>Service</u>

Totals

[Remainder of page intentionally left blank]

THE DISTRICT

General

The District is an independent local unit of special-purpose government created in accordance with the Act. The District was established under Ordinance No. 2022-60, which was enacted by the County on June 27, 2022, effective which became effective on June 29, 2022. The District encompasses approximately 205 gross acres of land located within the unincorporated municipal boundaries of the County. The District is located east of Lake Gentry Road, south of Hickory Tree Road, and west of Brick Lake. The District Lands are being developed as a planned residential community known as "[Hickory Tree]" (the "Development"). See "THE DEVELOPMENT" herein for more information.

Governance

The Act provides that a five-member Board of Supervisors (the "Board") serves as the governing body of the District. Members of the Board (the "Supervisors") must be residents of the State and citizens of the United States. Initially, the Supervisors were appointed in the Ordinance. Within 90 days after formation of the District, an election was held pursuant to which new Supervisors were elected on an at-large basis by the owners of the property within the District. Ownership of land within the District entitles the owner to one vote per acre (with fractions thereof rounded upward to the nearest whole number). A Supervisor serves until expiration of his or her term and until his or her successor is chosen and qualified. If, during a term of office, a vacancy occurs, the remaining Supervisors may fill the vacancy by an appointment of an interim Supervisor for the remainder of the unexpired term.

At the initial election held within 90 days after formation of the District, the landowners in the District elected two Supervisors to four-year terms and three Supervisors to two-year terms. Thereafter, the elections take place every two years, with the first such election being held on the first Tuesday in November, and subsequent elections being held on a date in November established by the Board. Upon the later of six years after the initial appointment of Supervisors and the year when the District next attains at least 250 qualified electors, Supervisors whose terms are expiring will begin to be elected by qualified electors of the District. A qualified elector is a registered voter who is at least eighteen years of age, a resident of the District and the State and a citizen of the United States. At the election where Supervisors are first elected by qualified electors, two Supervisors must be qualified electors and be elected by qualified electors, each elected to four-year terms. The seat of the remaining Supervisor whose term is expiring at such election shall be filled by a Supervisor who is elected by the landowners for a four-year term and who is not required to be a qualified elector. Thereafter, as terms expire, all Supervisors must be qualified electors and must be elected by qualified electors to serve staggered four-year terms.

Notwithstanding the foregoing, if at any time the Board proposes to exercise its ad valorem taxing power, prior to the exercise of such power, it shall call an election at which all Supervisors shall be elected by qualified electors in the District. Elections subsequent to such decision shall be held in a manner such that the Supervisors will serve four-year terms with staggered expiration dates in the manner set forth in the Act.

The Act provides that it shall not be an impermissible conflict of interest under State law governing public officials for a Supervisor to be a stockholder, officer or employee of an owner of the land within the District.

The current members of the Board and the date of expiration of the term of each member are set forth below:

<u>Name</u>	<u>Title</u>	<u>Term Expires</u>
Milton Andrade*	Chair	November 2026
Brian Walsh*	Vice-Chair	November 2026
Joel Adams*	Assistant Secretary	November 2024
Garret Parkinson*	Assistant Secretary	November 2024
Jeffrey Shenefield*	Assistant Secretary	November 2024

* Elected by the landowners; employee of or affiliated with the Developer or its affiliates.

A majority of the Supervisors constitutes a quorum for the purposes of conducting the business of the District and exercising its powers and for all other purposes. Action taken by the District shall be upon a vote of the majority of the Supervisors present unless general law or a rule of the District requires a greater number. All meetings of the Board are open to the public under the State's "sunshine" or open meetings law.

Legal Powers and Authority

The District is an independent unit of local government created pursuant to, and established in accordance with, the Act. The Act was enacted in 1980 to provide a uniform method for the establishment of independent districts to manage and finance basic community development services, including capital infrastructure required for community developments throughout the State of Florida. The Act provides legal authority for community development districts (such as the District) to finance the acquisition, construction, operation and maintenance of the major infrastructure for community development pursuant to its general law charter.

Among other provisions, the Act gives the District's Board of Supervisors the authority: (a) to finance, fund, plan, establish, acquire, construct or reconstruct, enlarge or extend, equip, operate and maintain systems, facilities, and basic infrastructure for, among other things: (i) water management and control for lands within the District and to connect any of such facilities with roads and bridges, (ii) water supply, sewer and waste-water management, reclamation and reuse systems or any combination thereof and to construct and operate connecting intercept or outlet sewers and sewer mains and pipes and water mains, conduits, or pipelines in, along, and under any street, alley, highway, or other public place or ways, and to dispose of any effluent, residue, or other byproducts of such system or sewer system, (iii) District roads equal to or exceeding the specifications of the county in which such District roads are located and street lights, landscaping, hardscaping and undergrounding of electric utility lines, (iv) conservation areas, mitigation areas, and wildlife habitat, (v) any other project, facility, or service required by a development approval, interlocal agreement, zoning condition, or permit issued by a governmental authority with jurisdiction in the District, and (vi) with the consent of the local general-purpose government within the jurisdiction of which the power is to be exercised, parks and facilities for indoor and outdoor recreational uses, and security; (b) to borrow money and issue bonds of the District; (c) to impose and foreclose special assessments liens as provided in the Act; and (d) to exercise all other powers, necessary, convenient, incidental or proper in connection with any of the powers or duties of the District stated in the Act.

Also, pursuant to the Ordinance, the District has been granted special powers pursuant to Sections 190.012(1), 190.012(2)(a) of the Act, as well as Sections 190.012(b) – (f) of the Act if said improvements and each of their specifications are first approved by the County. Such special powers include, but are not limited to, the right to (i) finance, fund, plan, establish, acquire, construct or reconstruct, enlarge or extend,

equip, operate, and maintain additional systems and facilities for parks and facilities for indoor and outdoor recreational, cultural and educational uses; and (ii) construct and maintain a perimeter wall/fence for the District so long as the construction and specifications of the wall/fence are first approved by the County.

The Act does not empower the District to adopt and enforce land use plans or zoning ordinances or to grant building permits; these functions are performed by the County, as applicable, acting through their respective Commissions and departments of government.

The Act exempts all property owned by the District from levy and sale by virtue of an execution and from judgment liens, but does not limit the right of any bondholders to pursue any remedy for enforcement of any lien or pledge of the District in connection with its bonds, including the Assessment Area One Bonds.

The District Manager and Other Consultants

The chief administrative official of the District is the District Manager. The Act provides that the District Manager shall have charge and supervision of the works of the District and shall be responsible for preserving and maintaining any improvement or facility constructed or erected pursuant to the provisions of the Act, for maintaining and operating the equipment owned by the District, and for performing such other duties as may be prescribed by the Board. Governmental Management Services – Central Florida, LLC, serves as District Manager. The District Manager's corporate office is located at 219 E. Livingston Street, Orlando, Florida 32801.

The Act further authorizes the Board to hire such employees and agents as it deems necessary. Thus, the District has employed the services of Kilinski | Van Wyk PLLC, Tallahassee, Florida, as District Counsel; Greenberg Traurig, P.A., Miami, Florida, as Bond Counsel; and Governmental Management Services – Central Florida, LLC, Orlando, Florida, serves as Methodology Consultant for the Assessment Area One Bonds.

No Outstanding Bond Indebtedness

The District has not previously issued any bonds or other similar debt obligations.

[Remainder of page intentionally left blank.]

THE CAPITAL IMPROVEMENT PLAN AND THE ASSESSMENT AREA ONE PROJECT

Dewberry Engineers Inc. (the "District Engineer") prepared a report entitled Hickory Tree Community Development District Engineer's Report, dated June 28, 2022 (the "Master Engineer's Report"), as supplemented by the report entitled [Hickory Tree Community Development District Supplemental Engineer's Report], dated [_____, 2023] (the "Supplemental Engineer's Report" and, collectively, the "Engineer's Report"), which sets forth certain public infrastructure improvements necessary for the development of 797 residential lots planned for the District Lands (the "Capital Improvement Plan" or "CIP"). The District Engineer estimates that the total cost of the Capital Improvement Plan is \$40,958,855.

The Capital Improvement Plan is being implemented in phases. The first phase of land development corresponds to Phases 1 and 2A of the Development and consists of approximately [91.94] acres, which are planned to contain 406 lots ("Assessment Area One"). The remaining 391 lots will be developed in the future.

The Assessment Area One Bonds will finance a portion of the Capital Improvement Plan (as described below, the "Assessment Area One Project"), which consists of clearing and mass grading [for all 797 lots planned for the Development], certain offsite improvements and the installation of onsite parcel infrastructure associated with the 406 lots planned for Assessment Area One. The District Engineer estimates the total cost of the Assessment Area One Project to be \$[_____], as more particularly described below.

Assessment Area One Project Description	Estimated Costs
Offsite Improvements	\$ _____
Utilities	_____
Electrical	_____
Roadway	_____
Entry Feature	_____
Parks and Amenities	_____
Consulting	_____
Contingency	_____
Total	\$ _____

The net proceeds of the Assessment Area One Bonds, consisting of approximately \$12.4 million,* will be used by the District towards the funding and/or acquisition of the Assessment Area One Project. See "THE DEVELOPMENT – Land Acquisition and Finance Plan" herein. The Developer will enter into a completion agreement at closing on the Assessment Area One Bonds, whereby it will agree to complete the Assessment Area One Project. See "BONDOWNERS' RISKS – Insufficient Resources or Other Factors Causing Failure to Complete Development" herein.

Land development associated with Assessment Area One will commence in [September 2023] and will be phased, with final completion expected by [_____] 2024. As of [_____] 2023, the Developer had spent approximately \$[___] million towards [hard and] soft costs associated with Assessment Area One, a portion of which includes the Assessment Area One Project.

The District expects to issue additional series of bonds to fund the remaining portions of the Capital Improvement Plan in the future. See "SECURITY FOR AND SOURCE OF PAYMENT OF THE

* Preliminary, subject to change.

ASSESSMENT AREA ONE BONDS – Additional Bonds" herein for limitations on additional bonds contained in the Indenture. Such bonds, if issued, will be secured by assessments levied on lands that are separate and distinct from Assessment Area One.

The District Engineer has indicated that all engineering permits necessary to construct the Assessment Area One Project, which are set forth in the Engineer's Report, have been obtained or will be obtained in the ordinary course of business. In addition to the Engineer's Report, please refer to "THE DEVELOPMENT – Development Approvals" for a more detailed description of the entitlement and permitting status of the Development.

See "APPENDIX A: ENGINEER'S REPORT" for more information regarding the above improvements.

Set forth below is a sketch of the District Lands, indicating the location of Assessment Area One.

[Sketch to be provided]

[Remainder of page intentionally left blank.]

ASSESSMENT METHODOLOGY AND THE ALLOCATION OF ASSESSMENTS

The Master Assessment Methodology for Hickory Tree Community Development District, dated June 28, 2022, as supplemented by the Preliminary First Supplemental Assessment Methodology (2023 Project) for Hickory Tree Community Development District, dated as of [_____, 2023] (collectively, the "Assessment Methodology"), which allocates the Assessment Area One Special Assessments to the lands within the District, has been prepared by Governmental Management Services – Central Florida, LLC, Orlando, Florida (the "Methodology Consultant"). See "EXPERTS" herein for more information. A copy of the Assessment Methodology is included herein as APPENDIX D. Once the final terms of the Assessment Area One Bonds are determined, the Assessment Methodology will be further supplemented to reflect such final terms. Once levied and imposed, the Assessment Area One Special Assessments are a first lien on the assessed lands within the District until paid or barred by operation of law, co-equal with other taxes and assessments levied by the District and other units of government. See "ENFORCEMENT OF ASSESSMENT COLLECTIONS" herein.

The Assessment Area One Bonds are secured primarily by the revenues received by the District from the levy of the Assessment Area One Special Assessments. As set forth in the Assessment Methodology, Assessment Area One Special Assessments will initially be levied on all of the approximately [91.94] gross acres within Assessment Area One, which are planned to contain 406 residential lots. As Assessment Area One is platted, the Assessment Area One Special Assessments will be assigned to platted lots therein as set forth in the Assessment Methodology. See "APPENDIX D: ASSESSMENT METHODOLOGY" for more information.

Upon platting of Assessment Area One, the estimated Assessment Area One Special Assessments levied and allocated to platted units to pay debt service on the Assessment Area One Bonds and the Assessment Area One Bond estimated par per unit are expected to be as follows:

Product Type	No. of Units	Annual Assessment Area One Special Assessments Per Unit*	Assessment Area One Bonds Par Debt Per Unit*
Townhomes	92	\$1,816	\$25,000
Single-Family 45'	44	\$2,906	\$40,000
Single-Family 50'	262	\$2,906	\$40,000
Single-Family 70'	8	\$2,906	\$40,000
Total	406		

* Preliminary, subject to change. Annual assessments collected via the Uniform Method will be subject to a gross up to account for estimated County collection costs/payment discounts, which may fluctuate. The Developer expects, but is not required, to make partial prepayments of the Assessment Area One Special Assessments to achieve target assessment levels in the amount of net annual amount of \$600 per townhome, \$1,350 per 45' lot, \$1,500 per 50' lot and \$2,100 per 70'. The total principal amount of such prepayments is expected to be \$7,640,000 (preliminary, subject to change.) See "BONDOWNERS' RISKS – Prepayment and Redemption Risk" herein.

The District expects to levy assessments to cover its operation and administrative costs which are expected to range from approximately \$750 to approximately \$1,250 per unit annually, based on product type, but such amounts are subject to change. The District Lands have been and will continue to be subject to taxes and assessments imposed by taxing authorities other than the District. These taxes would be payable in addition to the Assessment Area One Special Assessments and any other assessments levied by the District. In addition, exclusive of voter approved millages levied for general obligation bonds, as to which no limit applies, the County and the School Board of Osceola County each levy ad valorem taxes upon the land in the District. The District has no control over the level of ad valorem taxes and/or special assessments

levied by other taxing authorities. The total millage rate imposed on taxable properties in the District in 2022 was approximately 13.9769 mills; however such amount is subject to change in future tax years. It is possible that in future years taxes levied by these other entities could be substantially higher than in the current year. See "THE DEVELOPMENT – Taxes, Fees and Assessments" for more information.

[Remainder of page intentionally left blank.]

The information appearing below under the captions "THE DEVELOPMENT" and "THE DEVELOPER" has been furnished by the Developer for inclusion in this Limited Offering Memorandum and, although believed to be reliable, such information has not been independently verified by Bond Counsel, the District or its counsel, or the Underwriter or its counsel, and no persons other than the Developer makes any representation or warranty as to the accuracy or completeness of such information supplied by them. The following information is provided by the Developer as a means for the prospective bondholders to understand the anticipated development plan and risks associated with the Development. The Developer is not guaranteeing payment of the Assessment Area One Bonds or the Assessment Area One Special Assessments.

THE DEVELOPMENT

General Overview

The District encompasses approximately 205 gross acres located in unincorporated Osceola County. The District Lands are being developed as a residential community to be known as "[Hickory Tree]" (the "Development"). At buildout, the Development is planned to contain 797 residential units, together with recreation and amenity areas, parks, and associated infrastructure.

The Development is located east of Lake Gentry Road, south of Hickory Tree Road, and west of Brick Lake and is approximately five miles east of the Florida Turnpike, which provides access to Downtown Orlando approximately 45 minutes to the north. The major theme parks in the Orlando area are located approximately 30 minutes away from the Development. Set forth below is a map showing the general location of the Development:

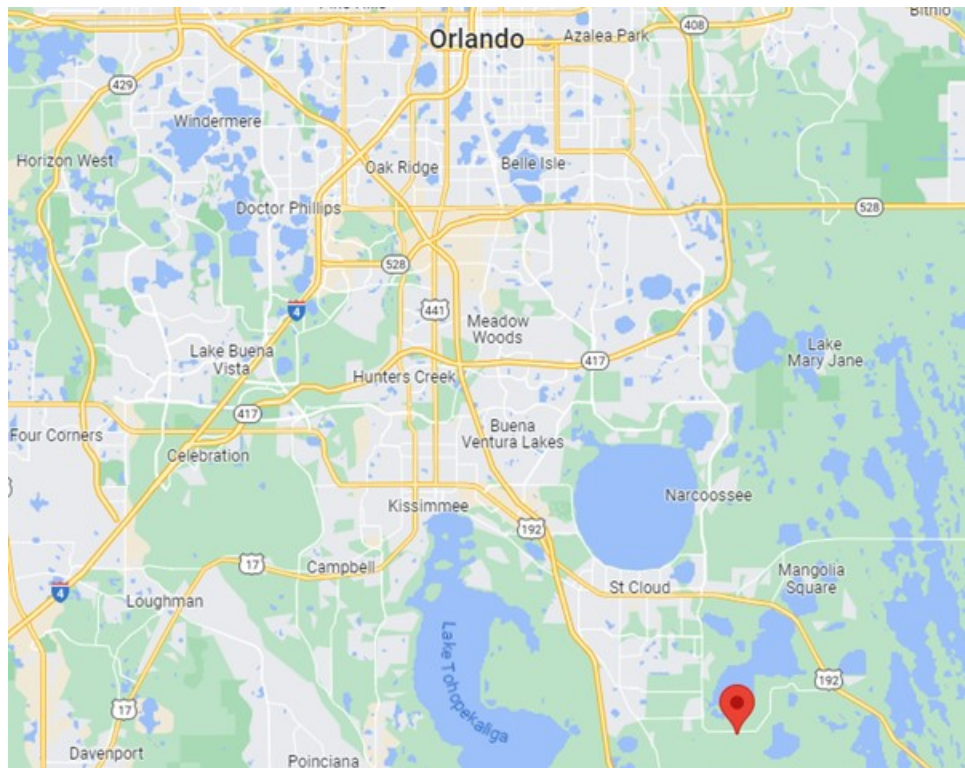

The Development is being developed in phases. Assessment Area One consists of approximately [91.94] acres of land, corresponding to Phases 1 and 2A, which are planned for 406 lots. The Assessment

Area One Bonds will finance a portion of the public infrastructure improvements associated with the development of Assessment Area One (the "Assessment Area One Project"). The public infrastructure associated with the development of the remaining 391 lots planned for the Development will be financed in the future.

The Assessment Area One Bonds will be secured by the Assessment Area One Special Assessments, which will initially be levied on the [91.94] acres of land within Assessment Area One. As lots are platted therein, the Assessment Area One Special Assessments will be assigned to platted lots on a first platted, first assigned basis as set forth in the Assessment Methodology attached hereto. See "ASSESSMENT METHODOLOGY AND THE ALLOCATION OF ASSESSMENTS" herein for more information.

Clayton Properties Group, Inc., a Tennessee corporation doing business as Highland Homes and a wholly owned subsidiary of Berkshire Hathaway (the "Developer"), is the developer and homebuilder for Assessment Area One. See "THE DEVELOPER" herein for more information.

Assessment Area One will consists of (i) 92 townhomes, (ii) 44 single-family detached homes on 45' wide lots, (iii) 262 single-family detached homes on 50' wide lots, and (iv) 8 single-family detached homes on 70' wide lots. Townhomes planned for Assessment Area One will range in size from approximately _____ square feet to _____ square feet and starting price points will range from approximately \$____,000 to \$____,000. Single-family homes planned for Assessment Area One will range in size from approximately _____ square feet to _____ square feet and starting price points will range from approximately \$____,000 to \$____,000. The target customers for units within the Development are first-time homebuyers and move-up buyers. See "-Residential Product Offerings" herein for more information.

Land Acquisition and Finance Plan

The Developer acquired title to the lands within the District, including Assessment Area One in December 2021 for approximately \$18,331,000. [The Developer subsequently entered into a land bank agreement with Land South Equities, LLC ("Land South"), whereby it transferred the District Lands outside of Assessment Area One to Land South, for a purchase price of approximately [\$13.7] million.] [The District Lands within Assessment Area One are not subject to a mortgage.] [The Developer owns all of the land within Assessment Area One.] [Please provide confirmation of Phase 2A buyback.]

The Developer estimates that the costs of the Assessment Area One Project are approximately \$[_____]. The Assessment Area One Project consists of clearing and mass grading for [all 797 lots planned for the Development], certain offsite improvements and the installation of onsite parcel infrastructure associated with the 406 lots planned for Assessment Area One. As of [_____], 2023, the Developer has spent approximately \$[_____] million on [hard and] soft costs associated with Assessment Area One.

The net proceeds of the Assessment Area One Bonds will be approximately \$12.4 million* and such proceeds will be used by the District towards the funding and/or acquisition of the Assessment Area One Project. The Developer will enter into a completion agreement that will obligate the Developer to complete any portions of the Assessment Area One Project not funded with proceeds of the Assessment Area One Bonds. See "BONDOWNERS' RISKS – Insufficient Resources or Other Factors Causing Failure to Complete Development" herein.

* Preliminary, subject to change.

Development Plan and Status

Land development for Assessment Area One will commence in [September] 2023 with mass grading for [all 797 lots planned for the Development] and installation of infrastructure will be phased as follows:

Phase 1. Phase 1 of the Development is planned to contain [] lots. Infrastructure installation for Phase 1 is expected to commence in [] and is expected to be completed by [], at which point sales and vertical construction for the Development will commence. A plat for the [] lots planned for Phase 1 is expected to be recorded by [].

Phase 2A. Phase 2A of the Development is planned to contain [] lots. Infrastructure installation for Phase 2A is expected to commence in [] and is expected to be completed by []. A plat for the [] lots planned for Phase 2A is expected to be recorded by [].

The Developer anticipates that approximately [] homes within Assessment Area One will be delivered per annum until buildout, with closings expected to commence by []. This anticipated absorption is based upon estimates and assumptions made by the Developer that are inherently uncertain, though considered reasonable by the Developer, and are subject to significant business, economic, and competitive uncertainties and contingencies, all of which are difficult to predict and many of which are beyond the control of the Developer. As a result, there can be no assurance such absorption rate will occur or be realized in the time frame anticipated.

Residential Product Offerings

The target customers for units within the Development are first-time homebuyers and move-up buyers. The following table reflects the Developer's current expectations for the homes planned for Assessments Area One, all of which are subject to change:

Product Type	Square Footage	Beds/Baths	Starting Price Points
Townhomes	_____ – _____	_ - _ Bedrooms, _ - _ Baths	\$____,000
Single-Family 45'	_____ – _____	_ - _ Bedrooms, _ - _ Baths	\$____,000
Single-Family 50'	_____ – _____	_ - _ Bedrooms, _ - _ Baths	\$____,000
Single-Family 70'	_____ – _____	_ - _ Bedrooms, _ - _ Baths	\$____,000

Development Approvals

[The District Engineer has indicated that all engineering permits necessary to construct the Assessment One Project have been obtained or are anticipated to be received in due course.] For more information regarding the permitting status of Assessment Area One, see "THE CAPITAL IMPROVEMENT PLAN AND THE ASSESSMENT AREA ONE PROJECT" herein and "APPENDIX A: ENGINEER'S REPORT" hereto. See also "BONDOWNERS' RISKS – Regulatory and Environmental Risks" herein

Environmental

A Phase I Environmental Site Assessment was performed on the District Lands, including the lands within Assessment Area One, on November 3, 2021 (the "ESA"). The ESA determined that the property was historically used as a citrus grove, which use constitutes a recognized environmental condition

(REC); however, based on the assumption that all chemicals associated with grove maintenance were applied in accordance with state and federal regulations, the ESA did not recommend further testing. See "BONDOWNERS' RISK – Regulatory and Environmental Risks" herein for more information regarding potential environmental risks.

Amenities

The Development will include an amenity center consisting of [parking area, pavilion with restroom facilities, pool, tot lot, all-purpose play field, and walking trails between the phases to provide connectivity to the Amenity Center, and passive parks throughout the Development which will include benches and walking trails] [please add/remove features as necessary] (collectively, the Amenities"). Construction of the Amenity Center is expected to commence in [_____] 202_ and is expected to be completed by [_____] 202_ at an approximate cost of \$[1.75] million, a portion of which is included within the Assessment Area One Project. The Amenities will be owned and operated by the District upon completion.

Utilities

Electric utilities will be provided to the Development by the Orlando Utilities Commission. Potable water, wastewater treatment and reclaimed wastewater (reuse services) for the Development are expected to be provided by the City of St. Cloud. See "APPENDIX A: ENGINEER'S REPORT" attached hereto for more information regarding the ownership and maintenance of utilities within the Development.

Taxes, Fees and Assessments

As set forth in the Assessment Methodology, the Assessment Area One Special Assessments are initially levied on the [91.94] gross acres within Assessment Area One, until such time as the lots planned therein are platted. As Assessment Area One is platted, the Assessment Area One Special Assessments will be assigned to the platted lots in Assessment Area One in accordance with the Assessment Methodology. See "ASSESSMENT METHODOLOGY AND THE ALLOCATION OF ASSESSMENTS" herein and "APPENDIX D: ASSESSMENT METHODOLOGY" hereto.

Upon platting of Assessment Area One, the estimated Assessment Area One Special Assessments levied and allocated to platted units to pay debt service on the Assessment Area One Bonds and the Assessment Area One Bond estimated par per unit are expected to be as follows:

Product Type	No. of Units	Annual Assessment Area One Special Assessments Per Unit*	Assessment Area One Bonds Par Debt Per Unit*
Townhomes	92	\$1,816	\$25,000
Single-Family 45'	44	\$2,906	\$40,000
Single-Family 50'	262	\$2,906	\$40,000
Single-Family 70'	8	\$2,906	\$40,000
Total	406		

* Preliminary, subject to change. Annual assessments collected via the Uniform Method will be subject to a gross up to account for estimated County collection costs/payment discounts, which may fluctuate. The Developer expects, but is not required, to make partial prepayments of the Assessment Area One Special Assessments to achieve target assessment levels in the amount of net annual amount of \$600 per townhome, \$1,350 per 45' lot, \$1,500 per 50' lot and \$2,100 per 70'. The total principal amount of such prepayments is expected to be \$7,640,000 (preliminary, subject to change.) See "BONDOWNERS' RISKS – Prepayment and Redemption Risk" herein.

The District anticipates levying assessments to cover its operation and maintenance costs that will range from \$750 – \$1,250, based on unit time, which amounts however are subject to change. In addition, residents will be required to pay homeowners' association fees, which are currently estimated to be \$[] per year per residential unit, which amount is subject to change. The land within the District has been and is expected to continue to be subject to taxes and assessments imposed by taxing authorities other than the District. The total millage rate imposed on taxable properties in the District in 2022 was approximately 13.9769 mills; however such amount is subject to change in future tax years. These taxes would be payable in addition to the Assessment Area One Special Assessments and any other assessments levied by the District. In addition, exclusive of voter approved millages levied for general obligation bonds, as to which no limit applies, the County and the School District of Osceola County, Florida may each levy ad valorem taxes upon the land in the District. The District has no control over the level of ad valorem taxes and/or special assessments levied by other taxing authorities. It is possible that in future years taxes levied by these other entities could be substantially higher than in the current year.

Education

The public schools for children residing in the Development are expected to be _____, _____, and _____, which are located approximately __ miles, __ miles, and __ miles from the Development, respectively, and which were rated __, __ and __, respectively, by the Florida Department of Education in 2022. The Osceola County School Board may change school boundaries from time to time and there is no requirement that students residing in the Development be permitted to attend the schools which are closest to the Development.

Competition

The following communities have been identified by the Developer as being competitive with the Development, because of their proximity to the Development, price ranges and product types. Those communities include [_____, _____, _____, and _____]. The foregoing does not purport to summarize all of the existing or planned communities in the area of the Development.

Developer Agreements

The Developer will enter into a completion agreement that will obligate the Developer to complete any portions of the Assessment Area One Project not funded with proceeds of the Assessment Area One Bonds. See "BONDOWNERS' RISKS – Insufficient Resources or Other Factors Causing Failure to Complete Development" herein.

In addition, the Developer will execute and deliver to the District a Collateral Assignment and Assumption of Development Rights (the "Collateral Assignment"), pursuant to which the Developer will collaterally assign to the District, to the extent assignable and to the extent that they are solely owned or controlled by the Developer, development rights relating the Assessment Area One Project. Notwithstanding such Collateral Assignment, in the event the District forecloses on the lands subject to the Assessment Area One Special Assessments as a result of the Developer's or subsequent landowners' failure

to pay such assessments, there is a risk that the District will not have all permits and entitlements necessary to complete the Assessment Area One Project or the development of Assessment Area One.

Finally, the Developer will also enter into a True-Up Agreement in connection with its obligations to pay true-up payments in the event that debt levels remaining on unplatted lands in Assessment Area One increase above the maximum debt levels set forth in the Assessment Methodology. See "APPENDIX D: ASSESSMENT METHODOLOGY" herein for additional information regarding the "true-up mechanism."

Such obligations of the Developer are unsecured obligations. See "BONDOWNERS' RISKS – Insufficient Resources or Other Factors Causing Failure to Complete Development" and "THE DEVELOPER" herein for more information regarding the Developer.

THE DEVELOPER

Clayton Properties Group, Inc., a Tennessee corporation doing business as Highland Homes ("Clayton Properties" or the "Developer"), owns all of the land within Assessment Area One and is serving as the land developer and one of the homebuilders for the Development.

The Developer has been in the business of building homes since 1956, and its network of builders built over 9,400 homes in 2020. Clayton Properties builds under the following names: Chaffin Communities, Goodall Homes, Summit Homes, Oakwood Homes, Harris Doyle Homes, Brohn Homes, Arbor Homes, Mungo Homes and Highland Homes. Homes in the Development will be built under the name of Highland Homes. In May 2019, the Developer acquired the Highland Homes name from Highland Holdings, Inc., a Florida corporation, which was founded in 1996 in Lakeland, Florida, by Robert J. and D. Joel Adams, who remain involved in development operations of the Developer. Highland Homes has built more than 13,000 homes in Florida and is currently building in eight counties, encompassing some 38 communities throughout the Central Florida region. Its primary focus is on the first-time homebuyer, with a secondary focus on first- and second-time move up buyers that it addresses in most of its markets. Highland Homes closed approximately 1,673 homes in 2021 and 1,364 homes in 2022. The Developer expects to close between 10,000 and 12,000 homes in 2023 across all of its brands.

Clayton Properties is wholly owned by Berkshire Hathaway, Inc. ("Berkshire Hathaway"). Berkshire Hathaway stock trades on the New York Stock Exchange under the symbols BRK.A and BRK.B. Berkshire Hathaway is subject to the informational requirements of the Securities Exchange Act of 1934, as amended (the "Exchange Act"), and in accordance therewith files reports, proxy statements, and other information with the Securities and Exchange Commission (the "SEC"). The file number for Berkshire Hathaway is No-1-14905. Such reports, proxy statements, and other information can be inspected and copied at the Public Reference Section of the SEC, Room 100 F Street, N.E., Washington, D.C. 20549 and at the SEC's internet website at <http://www.sec.gov>. Copies of such materials can be obtained by mail from the Public Reference Section of the SEC at prescribed rates. All documents subsequently filed by Berkshire Hathaway pursuant to the requirements of the Exchange Act after the date of this Limited Offering Memorandum will be available for inspection in the same manner as described above.

Neither the Developer nor any of the other individuals or entities listed above is guaranteeing payment of the Assessment Area One Special Assessments or the Assessment Area One Special Assessments. None of the entities listed herein, other than the Developer, has entered into any agreements in connection with the issuance of the Assessment Area One Special Assessments.

TAX MATTERS

General

The Internal Revenue Code of 1986, as amended (the "Code"), includes requirements that the District must continue to meet after the issuance of the Assessment Area One Bonds in order that the interest on the Assessment Area One Bonds be and remain excludable from gross income for federal income tax purposes. The District's failure to meet these requirements may cause the interest on the Assessment Area One Bonds to be included in gross income for federal income tax purposes retroactively to the date of issuance of the Assessment Area One Bonds. The District has covenanted in the Bond Resolution to take the actions required by the Code in order to maintain the exclusion from gross income for federal income tax purposes of interest on the Assessment Area One Bonds.

In the opinion of Greenberg Traurig, P.A., Bond Counsel, assuming the accuracy of certain representations and certifications and continuing compliance by the District with the tax covenants referred to above, under existing statutes, regulations, rulings, and court decisions, the interest on the Assessment Area One Bonds is excludable from gross income of the holders thereof for federal income tax purposes; and, further, interest on the Assessment Area One Bonds is not an item of tax preference for purposes of the federal alternative minimum tax imposed on individuals. In the case of the alternative minimum tax imposed by Section 55(b)(2) of the Code on applicable corporations (as defined in Section 59(k) of the Code), interest on the Assessment Area One Bonds is not excluded from the determination of adjusted financial statement income. Bond Counsel is further of the opinion that the Assessment Area One Bonds and the interest thereon are not subject to taxation under the laws of the State, except as to estate taxes and taxes under Chapter 220, Florida Statutes, on interest, income, or profits on debt obligations owned by corporations as defined in said Chapter 220. Bond Counsel will express no opinion as to any other tax consequences regarding the Assessment Area One Bonds. Prospective purchasers of the Assessment Area One Bonds should consult their own tax advisors as to the status of interest on the Assessment Area One Bonds under the tax laws of any state other than the State.

The above opinion on federal tax matters with respect to the Assessment Area One Bonds will be based on and will assume the accuracy of certain representations and certifications of the District and the Developer, and compliance with certain covenants of the District to be contained in the transcript of proceedings and that are intended to evidence and assure the foregoing, including that the Assessment Area One Bonds will be and will remain obligations the interest on which is excludable from gross income for federal income tax purposes. Bond Counsel will not independently verify the accuracy of those certifications and representations. Bond Counsel will express no opinion as to any other consequences regarding the Assessment Area One Bonds.

Except as described above, Bond Counsel will express no opinion regarding the federal income tax consequences resulting from the receipt or accrual of the interest on the Assessment Area One Bonds, or the ownership or disposition of the Assessment Area One Bonds. Prospective purchasers of Assessment Area One Bonds should be aware that the ownership of Assessment Area One Bonds may result in other collateral federal tax consequences, including (i) the denial of a deduction for interest on indebtedness incurred or continued to purchase or carry the Assessment Area One Bonds, (ii) the reduction of the loss reserve deduction for property and casualty insurance companies by the applicable statutory percentage of certain items, including the interest on the Assessment Area One Bonds, (iii) the inclusion of the interest on the Assessment Area One Bonds in the earnings of certain foreign corporations doing business in the United States for purposes of a branch profits tax, (iv) the inclusion of the interest on the Assessment Area One Bonds in the passive income subject to federal income taxation of certain Subchapter S corporations with Subchapter C earnings and profits at the close of the taxable year, (v) the inclusion of interest on the Assessment Area One Bonds in the determination of the taxability of certain Social Security and Railroad

Retirement benefits to certain recipients of such benefits, (vi) net gain realized upon the sale or other disposition of property such as the Assessment Area One Bonds generally must be taken into account when computing the Medicare tax with respect to net investment income or undistributed net investment income, as applicable, imposed on certain high income individuals and specified trusts and estates and (vii) receipt of certain investment income, including interest on the Assessment Area One Bonds, is considered when determining qualification limits for obtaining the earned income credit provided by Section 32(a) of the Code. The nature and extent of the other tax consequences described above will depend on the particular tax status and situation of each owner of the Assessment Area One Bonds. Prospective purchasers of the Assessment Area One Bonds should consult their own tax advisors as to the impact of these and any other tax consequences.

Bond Counsel's opinion is based on existing law, which is subject to change. Such opinion is further based on factual representations made to Bond Counsel as of the date of issuance of the Assessment Area One Bonds. Bond Counsel assumes no duty to update or supplement its opinion to reflect any facts or circumstances that may thereafter come to Bond Counsel's attention, or to reflect any changes in law that may thereafter occur or become effective. Moreover, Bond Counsel's opinion is not a guarantee of a particular result, and is not binding on the IRS or the courts; rather, such opinion represents Bond Counsel's professional judgment based on its review of existing law, and in reliance on the representations and covenants that it deems relevant to such opinion.

Original Issue Discount and Premium

Certain of the Assessment Area One Bonds ("Discount Bonds") may be offered and sold to the public at an original issue discount ("OID"). OID is the excess of the stated redemption price at maturity (the principal amount) over the "issue price" of a Discount Bond determined under Code Section 1273 or 1274 (*i.e.*, for obligations issued for money in a public offering, the initial offering price to the public (other than to bond houses and brokers) at which a substantial amount of the obligation of the same maturity is sold pursuant to that offering). For federal income tax purposes, OID accrues to the owner of a Discount Bond over the period to maturity based on the constant yield method, compounded semiannually (or over a shorter permitted compounding interval selected by the owner). The portion of OID that accrues during the period of ownership of a Discount Bond (i) is interest excludable from the owner's gross income for federal income tax purposes to the same extent, and subject to the same considerations discussed above, as other interest on the Assessment Area One Bonds, and (ii) is added to the owner's tax basis for purposes of determining gain or loss on the maturity, redemption, prior sale, or other disposition of that Discount Bond.

Certain of the Assessment Area One Bonds ("Premium Bonds") may be offered and sold to the public at a price in excess of their stated redemption price (the principal amount) at maturity (or earlier for certain Premium Bonds callable prior to maturity). That excess constitutes bond premium. For federal income tax purposes, bond premium is amortized over the period to maturity of a Premium Bond, based on the yield to maturity of that Premium Bond (or, in the case of a Premium Bond callable prior to its stated maturity, the amortization period and yield may be required to be determined on the basis of an earlier call date that results in the lowest yield on that Premium Bond), compounded semiannually (or over a shorter permitted compounding interval selected by the owner). No portion of that bond premium is deductible by the owner of a Premium Bond. For purposes of determining the owner's gain or loss on the sale, redemption (including redemption at maturity), or other disposition of a Premium Bond, the owner's tax basis in the Premium Bond is reduced by the amount of bond premium that accrues during the period of ownership. As a result, an owner may realize taxable gain for federal income tax purposes from the sale or other disposition of a Premium Bond for an amount equal to or less than the amount paid by the owner for that Premium Bond.

Owners of Discount and Premium Bonds should consult their own tax advisers as to the determination for federal income tax purposes of the amount of OID or bond premium properly accruable in any period with respect to the Discount or Premium Bonds and as to other federal tax consequences, and the treatment of OID and bond premium for purposes of state and local taxes on, or based on, income.

Changes in Federal and State Tax Law

From time to time, there are legislative proposals suggested, debated, introduced, or pending in Congress or in the State legislature that, if enacted into law, could alter or amend one or more of the federal tax matters, or state tax matters, respectively, described above including, without limitation, the excludability from gross income of interest on the Assessment Area One Bonds, or adversely affect the market price or marketability of the Assessment Area One Bonds, or otherwise prevent the holders from realizing the full current benefit of the status of the interest thereon. It cannot be predicted whether or in what form any such proposal may be enacted, or whether, if enacted, any such proposal would affect the Assessment Area One Bonds. Prospective purchasers of the Assessment Area One Bonds should consult their tax advisors as to the impact of any proposed or pending legislation.

On August 16, 2022, President Biden signed the Inflation Reduction Act of 2022 (H.R. 5376) into law. For tax years beginning after 2022, this legislation will impose a minimum tax of 15 percent on the adjusted financial statement income of applicable corporations as defined in Section 59(k) of the Code (which is primarily designed to impose a minimum tax on certain large corporations). For this purpose, adjusted financial statement income is not reduced for interest earned on tax-exempt obligations. Prospective purchasers that could be subject to this minimum tax should consult with their own tax advisors regarding the potential consequences of owning the Assessment Area One Bonds.

Information Reporting and Backup Withholding

Interest paid on tax-exempt bonds such as the Assessment Area One Bonds is subject to information reporting to the Internal Revenue Service in a manner similar to interest paid on taxable obligations. This reporting requirement does not affect the excludability of interest on the Assessment Area One Bonds from gross income for federal income tax purposes. However, in conjunction with that information reporting requirement, the Code subjects certain non-corporate owners of Assessment Area One Bonds, under certain circumstances, to "backup withholding" at the rates set forth in the Code, with respect to payments on the Assessment Area One Bonds and proceeds from the sale of Assessment Area One Bonds. Any amount so withheld would be refunded or allowed as a credit against the federal income tax of such owner of Assessment Area One Bonds. This withholding generally applies if the owner of Assessment Area One Bonds (i) fails to furnish the payor such owner's social security number or other taxpayer identification number ("TIN"), (ii) furnished the payor an incorrect TIN, (iii) fails to properly report interest, dividends, or other "reportable payments" as defined in the Code, or (iv) under certain circumstances, fails to provide the payor or such owner's securities broker with a certified statement, signed under penalty of perjury, that the TIN provided is correct and that such owner is not subject to backup withholding. Prospective purchasers of the Assessment Area One Bonds may also wish to consult with their tax advisors with respect to the need to furnish certain taxpayer information in order to avoid backup withholding.

AGREEMENT BY THE STATE

Under the Act, the State pledges to the holders of any bonds issued thereunder, including the Assessment Area One Bonds, that it will not limit or alter the rights of the issuer of such bonds, including the District, to own, acquire, construct, reconstruct, improve, maintain, operate or furnish the projects, including the Assessment Area One Project funded by the Assessment Area One Bonds, or to levy and collect taxes, assessments, rentals, rates, fees and other charges provided for in the Act and to fulfill the

terms of any agreement made with the holders of such bonds and that it will not in any way impair the rights or remedies of such holders.

LEGALITY FOR INVESTMENT

The Act provides that bonds issued by community development districts are legal investments for savings banks, banks, trust companies, insurance companies, executors, administrators, trustees, guardians, and other fiduciaries, and for any board, body, agency, instrumentality, county, municipality or other political subdivision of the State, and constitute securities that may be deposited by banks or trust companies as security for deposits of state, county, municipal or other public funds, or by insurance companies as required or voluntary statutory deposits.

SUITABILITY FOR INVESTMENT

In accordance with applicable provisions of Florida law, the Assessment Area One Bonds may initially be sold by the District only to "accredited investors" within the meaning of Chapter 517, Florida Statutes, and the rules of the Florida Department of Financial Services promulgated thereunder. The limitation of the initial offering to accredited investors does not denote restrictions on transfers in any secondary market for the Assessment Area One Bonds. Investment in the Assessment Area One Bonds poses certain economic risks. No dealer, broker, salesman or other person has been authorized by the District or the Underwriter to give any information or make any representations, other than those contained in this Limited Offering Memorandum, and, if given or made, such other information or representations must not be relied upon as having been authorized by either of the foregoing.

ENFORCEABILITY OF REMEDIES

The remedies available to the owners of the Assessment Area One Bonds upon an event of default under the Indenture are in many respects dependent upon judicial actions, which are often subject to discretion and delay. Under existing constitutional and statutory law and judicial decisions, including the federal bankruptcy code, the remedies specified by the Indenture and the Assessment Area One Bonds may not be readily available or may be limited. The various legal opinions to be delivered concurrently with the delivery of the Assessment Area One Bonds will be qualified, as to the enforceability of the remedies provided in the various legal instruments, by limitations imposed by bankruptcy, reorganization, insolvency or other similar laws affecting the rights of creditors and enacted before or after such delivery.

FINANCIAL STATEMENTS

This District will covenant in a Continuing Disclosure Agreement, the proposed form of which is set forth in APPENDIX E hereto, to provide its annual audited financial statements to certain information repositories as described in APPENDIX E, commencing with the audit for the District fiscal year ending September 30, [2023]. Attached hereto as APPENDIX F is a copy of the District's unaudited monthly financial statements for the period ended [June 30, 2023]. The District does not have audited financial statements because the District has only recently been established. As of the date hereof, the District does not have any significant assets or liabilities and the District has not previously issued any debt obligations. The Assessment Area One Bonds are not general obligation bonds of the District and are payable solely from the Assessment Area One Pledged Revenues.

Beginning October 1, 2015, or by the end of the first full fiscal year after its creation, each community development district in Florida must have a separate website with certain information as set forth in Section 189.069, F.S., including, without limitation, the district's proposed and final budgets and

audit. Additional information regarding the District's website is available from the District Manager at the address set forth under "THE DISTRICT – The District Manager and Other Consultants."

LITIGATION

The District

There is no litigation of any nature now pending or, to the knowledge of the District threatened, seeking to restrain or enjoin the issuance, sale, execution or delivery of the Assessment Area One Bonds, or in any way contesting or affecting (i) the validity of the Assessment Area One Bonds or any proceedings of the District taken with respect to the issuance or sale thereof, (ii) the pledge or application of any moneys or security provided for the payment of the Assessment Area One Bonds, (iii) the existence or powers of the District or (iv) the validity of the Assessment Proceedings.

The Developer

The Developer has represented in connection with the Assessment Area One Bond issuance that there is no litigation of any nature now pending or, to the knowledge of the Developer, threatened, which could reasonably be expected to have a material and adverse effect upon the ability of the Developer to complete the development of the District Lands as described herein, materially and adversely affect the ability of the Developer to pay the Assessment Area One Special Assessments imposed against the District Lands or materially and adversely affect the ability of the Developer to perform its obligations described in this Limited Offering Memorandum.

NO RATING

No application for a rating of the Assessment Area One Bonds has been made to any rating agency, nor is there any reason to believe that the District would have been successful in obtaining an investment grade rating for the Assessment Area One Bonds had application been made.

DISCLOSURE REQUIRED BY FLORIDA BLUE SKY REGULATIONS

Section 517.051, Florida Statutes, and the regulations promulgated thereunder requires that the District make a full and fair disclosure of any bonds or other debt obligations that it has issued or guaranteed and that are or have been in default as to principal or interest at any time after December 31, 1975 (including bonds or other debt obligations for which it has served only as a conduit issuer such as industrial development or private activity bonds issued on behalf of private business). The District is not and has never been in default on any bonds or other debt obligations since December 31, 1975.

CONTINUING DISCLOSURE

The District and the Developer will enter into the Continuing Disclosure Agreement (the "Disclosure Agreement") in the proposed form of APPENDIX E, for the benefit of the Assessment Area One Bondholders (including owners of beneficial interests in such Assessment Area One Bonds), to provide certain financial information and operating data relating to the District and the Development by certain dates prescribed in the Disclosure Agreement (the "Reports") with the MSRB through the MSRB's EMMA system. The specific nature of the information to be contained in the Reports is set forth in "APPENDIX E: PROPOSED FORM OF CONTINUING DISCLOSURE AGREEMENT." Under certain circumstances, the failure of the District or the Developer to comply with their respective obligations under the Disclosure Agreement constitutes an event of default thereunder. Such a default will not constitute an event of default under the Indenture, but such event of default under the Disclosure Agreement would allow the Assessment

Area One Bondholders (including owners of beneficial interests in such Assessment Area One Bonds) to bring an action for specific performance.

The District has not previously issued any bonds and has not previously entered into any continuing disclosure obligations pursuant to Rule 15c2-12, promulgated under the Securities Exchange Act of 1934, as amended (the "Rule"). The District anticipates satisfying all future disclosure obligations required pursuant to its Disclosure Agreement and the Rule. The District will appoint Governmental Management Services – Central Florida, LLC, as the dissemination agent in the Disclosure Agreement.

The Developer has previously entered into continuing disclosure undertakings pursuant to the Rule with respect to bonds issued by other community development districts. A review of filings made pursuant to such prior undertakings indicates that certain filings required to be made by the Developer were not timely filed and that notice of such late filings was not always provided. The Developer anticipates satisfying all disclosure obligations required pursuant to the Disclosure Agreement and the Rule.

UNDERWRITING

FMSbonds, Inc. (the "Underwriter"), has agreed, pursuant to a contract with the District, subject to certain conditions, to purchase the Assessment Area One Bonds from the District at a purchase price of \$_____ (par amount of the Assessment Area One Bonds, [plus/less an original issue premium/discount of \$_____ and] less an Underwriter's discount of \$_____). The Underwriter's obligations are subject to certain conditions precedent and the Underwriter will be obligated to purchase all of the Assessment Area One Bonds if any Assessment Area One Bonds are purchased.

The Assessment Area One Bonds may be offered and sold to certain dealers, banks and others at prices lower than the initial offering prices, and such initial offering prices may be changed from time to time by the Underwriter.

CONTINGENT FEES

The District has retained Bond Counsel, District Counsel, the Consulting Engineer, the District Manager/Methodology Consultant, the Underwriter (who has retained Underwriter's Counsel) and the Trustee (which has retained Trustee's counsel), with respect to the authorization, sale, execution and delivery of the Assessment Area One Bonds. Except for the payment of certain fees to District Counsel, the Consulting Engineer and the District Manager, the payment of fees of the other professionals is each contingent upon the issuance of the Assessment Area One Bonds.

EXPERTS

Dewberry Engineers Inc., as District Engineer, has prepared the Engineer's Report included herein as APPENDIX A, which report should be read in its entirety. Governmental Management Services – Central Florida, LLC, as the Methodology Consultant, has prepared the Assessment Methodology included herein as APPENDIX D, which report should be read in its entirety. As a condition to closing on the Assessment Area One Bonds, both the District Engineer and the Methodology Consultant will consent to the inclusion of their reports in this Limited Offering Memorandum.

VALIDATION

Bonds issued pursuant to the terms of the Master Indenture have been validated by a judgment of the Circuit Court of the Ninth Judicial Circuit Court of Florida in and for Osceola County, Florida, rendered

on December 22, 2022. The period of time in which an appeal of the judgment may be filed has expired with no appeals having being taken.

LEGAL MATTERS

Certain legal matters related to the authorization, sale and delivery of the Assessment Area One Bonds are subject to the approval of Greenberg Traurig, P.A., Miami, Florida, Bond Counsel. Certain legal matters will be passed upon for the Underwriter by its counsel, GrayRobinson, P.A. Tampa, Florida. Certain legal matters will be passed upon for the District by its counsel, Kilinski | Van Wyk PLLC, Tallahassee, Florida. Certain legal matters will be passed upon for the Developer by its counsel, Johnson Pope Bokor Ruppel & Burns, LLP, Tampa, Florida.

The form of opinion of Bond Counsel attached hereto as APPENDIX C is based on existing law, which is subject to change, and is further based on factual representations made to Bond Counsel as of the date hereof. Bond Counsel assumes no duty to update or supplement its opinion to reflect any facts or circumstances that may thereafter come to Bond Counsel's attention, or to reflect any changes in law that may thereafter occur or become effective. Moreover, Bond Counsel's opinion is not a guarantee of a particular result and is not binding on the Internal Revenue Service or the courts; rather, such opinion represents Bond Counsel's professional judgment based on its review of existing law, and in reliance on the representations and covenants that it deems relevant to such opinion.

MISCELLANEOUS

Any statements made in this Limited Offering Memorandum involving matters of opinion or estimates, whether or not expressly so stated, are set forth as such and not as representations of fact, and no representations are made that any of the estimates will be realized.

The references herein to the Assessment Area One Bonds and other documents referred to herein are brief summaries of certain provisions thereof. Such summaries do not purport to be complete and reference is made to such documents for full and complete statements of such provisions.

This Limited Offering Memorandum is submitted in connection with the limited offering of the Assessment Area One Bonds and may not be reproduced or used, as a whole or in part, for any other purpose. This Limited Offering Memorandum is not to be construed as a contract with the purchaser or the Beneficial Owners of any of the Assessment Area One Bonds.

[Remainder of page intentionally left blank.]

AUTHORIZATION AND APPROVAL

The execution and delivery of this Limited Offering Memorandum has been duly authorized by the Board of Supervisors of Hickory Tree Community Development District.

**HICKORY TREE COMMUNITY
DEVELOPMENT DISTRICT**

By: _____
Chairperson, Board of Supervisors

APPENDIX A

ENGINEER'S REPORT

APPENDIX B

**PROPOSED FORMS OF MASTER INDENTURE AND
FIRST SUPPLEMENTAL INDENTURE**

APPENDIX C

PROPOSED FORM OF OPINION OF BOND COUNSEL

APPENDIX D

ASSESSMENT METHODOLOGY

APPENDIX E

PROPOSED FORM OF CONTINUING DISCLOSURE AGREEMENT

APPENDIX F
DISTRICT'S FINANCIAL STATEMENTS

EXHIBIT D

FORM OF RULE 15c2-12 CERTIFICATE

Hickory Tree Community Development District
\$ _____* Special Assessment Bonds,
Series 2023
(Assessment Area One Project)

The undersigned hereby certifies and represents to FMSbonds, Inc. ("Underwriter") that he is the Chairperson of the Board of Supervisors of Hickory Tree Community Development District (the "District") is authorized to execute and deliver this Certificate, and further certifies on behalf of the District to the Underwriter as follows:

1. This Certificate is delivered to enable the Underwriter to comply with Rule 15c2-12 under the Securities Exchange Act of 1934 (the "Rule") in connection with the offering and sale of the above captioned bonds (the "Assessment Area One Bonds").

2. In connection with the offering and sale of the Assessment Area One Bonds, there has been prepared a Preliminary Limited Offering Memorandum, dated the date hereof, setting forth information concerning the Assessment Area One Bonds and the District (the "Preliminary Limited Offering Memorandum").

3. As used herein, "Permitted Omissions" shall mean the offering price, interest rate, selling compensation, aggregate principal amount, principal amount per maturity, delivery dates, ratings, the identity of the Underwriter and other terms of the Assessment Area One Bonds depending on such matters.

4. The undersigned hereby deems the Preliminary Limited Offering Memorandum "final" as of its date, within the meaning of the Rule, except for the Permitted Omissions, and the information therein is accurate and complete except for the Permitted Omissions.

5. If, at any time prior to the execution of a Bond Purchase Contract, any event occurs as a result of which the Preliminary Limited Offering Memorandum might include an untrue statement of a material fact or omit to state any material fact necessary to make the statements therein, in light of the circumstances under which they were made, not misleading, the District will promptly notify the Underwriter thereof.

IN WITNESS WHEREOF, the undersigned has hereunto set his hand this ____ day of _____, 2023.

**HICKORY TREE COMMUNITY
DEVELOPMENT DISTRICT**

Chairperson

* Preliminary, subject to change.

EXHIBIT E

FORM OF CONTINUING DISCLOSURE AGREEMENT

CONTINUING DISCLOSURE AGREEMENT

This Continuing Disclosure Agreement (this "Disclosure Agreement") dated as of [____], 2023 is executed and delivered by the Hickory Tree Community Development District (the "Issuer" or the "District"), Clayton Properties Group, Inc., a Tennessee corporation doing business as Highland Homes (the "Developer"), and Governmental Management Services – Central Florida, LLC, a Florida limited liability company, as dissemination agent (the "Dissemination Agent") in connection with the Issuer's Special Assessment Bonds, Series 2023 (Assessment Area One Project) (the "Bonds"). The Bonds are secured pursuant to a Master Trust Indenture dated as of [____] 1, 2023 (the "Master Indenture") and a First Supplemental Trust Indenture dated as of [____] 1, 2023 (the "First Supplemental Indenture" and, together with the Master Indenture, the "Indenture"), each entered into by and between the Issuer and U.S. Bank Trust Company, National Association, a national banking association duly organized and existing under the laws of the United States of America and having a designated corporate trust office in Fort Lauderdale, Florida, as trustee (the "Trustee"). The Issuer, the Developer and the Dissemination Agent covenant and agree as follows:

1. **Purpose of this Disclosure Agreement.** This Disclosure Agreement is being executed and delivered by the Issuer, the Developer and the Dissemination Agent for the benefit of the Beneficial Owners (as defined herein) of the Bonds and to assist the Participating Underwriter (as defined herein) of the Bonds in complying with the Rule (as defined herein). The Issuer has no reason to believe that this Disclosure Agreement does not satisfy the requirements of the Rule and the execution and delivery of this Disclosure Agreement is intended to comply with the Rule. To the extent it is later determined by a court of competent jurisdiction, a governmental regulatory agency, or an attorney specializing in federal securities law, that the Rule requires the Issuer or other Obligated Person (as defined herein) to provide additional information, the Issuer and each Obligated Person agree to promptly provide such additional information.

The provisions of this Disclosure Agreement are supplemental and in addition to the provisions of the Indenture with respect to reports, filings and notifications provided for therein, and do not in any way relieve the Issuer, the Trustee or any other person of any covenant, agreement or obligation under the Indenture (or remove any of the benefits thereof) nor shall anything herein prohibit the Issuer, the Trustee or any other person from making any reports, filings or notifications required by the Indenture or any applicable law.

2. **Definitions.** Capitalized terms not otherwise defined in this Disclosure Agreement shall have the meaning assigned in the Rule or, to the extent not in conflict with the Rule, in the Indenture. The following capitalized terms as used in this Disclosure Agreement shall have the following meanings:

"Annual Filing Date" means the date set forth in Section 3(a) hereof by which the Annual Report is to be filed with each Repository.

"Annual Financial Information" means annual financial information as such term is used in paragraph (b)(5)(i)(A) of the Rule and specified in Section 4(a) of this Disclosure Agreement.

"Annual Report" shall mean any Annual Report provided by the Issuer pursuant to, and as described in, Sections 3 and 4 of this Disclosure Agreement.

"Assessment Area" shall mean that portion of the District lands subject to the Assessments, being more particularly described in the Limited Offering Memorandum as Assessment Area One.

"Assessments" shall mean the non-ad valorem Assessment Area One Special Assessment pledged to the payment of the Bonds pursuant to the Indenture.

"Audited Financial Statements" means the financial statements (if any) of the Issuer for the prior Fiscal Year, certified by an independent auditor as prepared in accordance with generally accepted accounting principles or otherwise, as such term is used in paragraph (b)(5)(i) of the Rule and specified in Section 4(a) of this Disclosure Agreement.

"Audited Financial Statements Filing Date" means the date set forth in Section 3(a) hereof by which the Audited Financial Statements are to be filed with each Repository if the same are not included as part of the Annual Report.

"Beneficial Owner" shall mean any person which, (a) has the power, directly or indirectly, to vote or consent with respect to, or to dispose of ownership of, any Bonds (including persons holding Bonds through nominees, depositories or other intermediaries), or (b) is treated as the owner of any Bonds for federal income tax purposes.

"Bond Year" means the annual period beginning on the second day of November of each year and ending on the first day of November of the following year.

"Business Day" means any day other than (a) a Saturday, Sunday or a day on which banks located in the city in which the designated corporate trust office of the Trustee is located are required or authorized by law or executive order to close for business, and (b) a day on which the New York Stock Exchange is closed.

"Disclosure Representative" shall mean (i) as to the Issuer, the District Manager or its designee, or such other person as the Issuer shall designate in writing to the Dissemination Agent from time to time as the person responsible for providing information to the Dissemination Agent; and (ii) as to each entity comprising an Obligated Person (other than the Issuer), the individuals executing this Disclosure Agreement on behalf of such entity or such person(s) as such entity shall designate in writing to the Dissemination Agent from time to time as the person(s) responsible for providing information to the Dissemination Agent.

"Dissemination Agent" shall mean the Issuer or an entity appointed by the Issuer to act in the capacity as Dissemination Agent hereunder, or any successor Dissemination Agent designated in writing by the Issuer pursuant to Section 8 hereof. Governmental Management Services – Central Florida, LLC has been designated as the initial Dissemination Agent hereunder.

"District Manager" shall mean Governmental Management Services – Central Florida, LLC, and its successors and assigns.

"EMMA" means the Electronic Municipal Market Access system for municipal securities disclosures located at <http://emma.msrb.org/>.

"EMMA Compliant Format" shall mean a format for any document provided to the MSRB (as hereinafter defined) which is in an electronic format and is accompanied by identifying information, all as prescribed by the MSRB.

"Financial Obligation" means a (a) debt obligation, (b) derivative instrument entered into in connection with, or pledged as security or a source of payment for, an existing or planned debt obligation, or (c) guarantee of an obligation or instrument described in either clause (a) or (b). Financial Obligation shall not include municipal securities as to which a final official statement has been provided to the MSRB consistent with the Rule.

"Fiscal Year" shall mean the period commencing on October 1 and ending on September 30 of the next succeeding year, or such other period of time provided by applicable law.

"Limited Offering Memorandum" shall mean that Limited Offering Memorandum dated [____], 2023, prepared in connection with the issuance of the Bonds.

"Listed Events" shall mean any of the events listed in Section 6(a) of this Disclosure Agreement.

"MSRB" means the Municipal Securities Rulemaking Board.

"Obligated Person(s)" shall mean, with respect to the Bonds, those person(s) who either generally or through an enterprise fund or account of such persons are committed by contract or other arrangement to support payment of all or a part of the obligations on such Bonds (other than providers of municipal bond insurance, letters of credit, or other liquidity facilities), which person(s) shall include the Issuer, and for the purposes of this Disclosure Agreement, the Developer for so long as such Developer or their affiliates, successors or assigns (excluding residential homebuyers who are end users) are the owners of District Lands responsible for payment of at least 20% of the Assessments.

"Participating Underwriter" shall mean FMSbonds, Inc.

"Quarterly Filing Date" shall mean for the quarter ending: (i) March 31, each May 1; (ii) June 30, each August 1; (iii) September 30, each November 1; and (iv) December 31, each February 1 of the following year. The first Quarterly Filing Date shall be [May] 1, 2024.

"Quarterly Report" shall mean any Quarterly Report provided by any Obligated Person (other than the Issuer) pursuant to, and as described in, Section 5 of this Disclosure Agreement.

"Repository" shall mean each entity authorized and approved by the SEC (as hereinafter defined) from time to time to act as a repository for purposes of complying with the Rule. The Repositories approved by the SEC may be found by visiting the SEC's website at <http://www.sec.gov/info/municipal/nrmsir.htm>. As of the date hereof, the Repository recognized by the SEC for such purpose is the MSRB, which currently accepts continuing disclosure

submissions through its EMMA web portal. As used herein, "Repository" shall include the State Repository, if any.

"Rule" shall mean Rule 15c2-12(b)(5) adopted by the Securities and Exchange Commission under the Securities Exchange Act of 1934, as the same has and may be amended from time to time.

"SEC" means the Securities and Exchange Commission.

"State" shall mean the State of Florida.

"State Repository" shall mean any public or private repository or entity designated by the State as a state repository for the purposes of the Rule.

3. **Provision of Annual Reports.**

(a) Subject to the following sentence, the Issuer shall provide the Annual Report to the Dissemination Agent no later than March 31st following the close of the Issuer's Fiscal Year (the "Annual Filing Date"), commencing with the Annual Report for the Fiscal Year ending [September 30, 2023]. The Annual Report may be submitted as a single document or as separate documents comprising a package, and may cross-reference other information as provided in Section 4 of this Disclosure Agreement; *provided that* the Audited Financial Statements of the Issuer may be submitted separately from the balance of the Annual Report, and may be submitted in accordance with State law, which currently requires such Audited Financial Statements to be provided up to, but no later than, nine (9) months after the close of the Issuer's Fiscal Year (the "Audited Financial Statements Filing Date"). The Issuer shall, or shall cause the Dissemination Agent to, provide to the Repository the components of an Annual Report which satisfies the requirements of Section 4(a) of this Disclosure Agreement within thirty (30) days after same becomes available, but in no event later than the Annual Filing Date or Audited Financial Statements Filing Date, if applicable. If the Issuer's Fiscal Year changes, the Issuer shall give notice of such change in the same manner as for a Listed Event under Section 6.

(b) If on the fifteenth (15th) day prior to each Annual Filing Date or the Audited Financial Statements Filing Date, as applicable, the Dissemination Agent has not received a copy of the Annual Report or Audited Financial Statements, as applicable, the Dissemination Agent shall contact the Disclosure Representative by telephone and in writing (which may be via email) to remind the Issuer of its undertaking to provide the Annual Report or Audited Financial Statements, as applicable, pursuant to Section 3(a). Upon such reminder, the Disclosure Representative shall either (i) provide the Dissemination Agent with an electronic copy of the Annual Report or the Audited Financial Statements, as applicable, in accordance with Section 3(a) above, or (ii) advise the Dissemination Agent in writing that the Issuer will not be able to file the Annual Report or Audited Financial Statements, as applicable, within the times required under this Disclosure Agreement, state the date by which the Annual Report or the Audited Financial Statements for such year, as applicable, will be provided and instruct the Dissemination Agent that a Listed Event as described in Section 6(a)(xvii) has occurred and to immediately send a notice to the Repository in substantially the form attached hereto as Exhibit A.

(c) If the Dissemination Agent has not received an Annual Report by 12:00 noon on the first (1st) Business Day following the Annual Filing Date for the Annual Report or the Audited Financial Statements by 12:00 noon on the first (1st) Business Day following the Audited Financial Statements Filing Date for the Audited Financial Statements, then a Listed Event as described in Section 6(a)(xvii) shall have occurred and the Dissemination Agent shall immediately send a notice to the Repository in substantially the form attached as Exhibit A.

(d) The Dissemination Agent shall:

(i) determine each year prior to the Annual Filing Date the name, address and filing requirements of the Repository; and

(ii) promptly upon fulfilling its obligations under subsection (a) above, file a notice with the Issuer stating that the Annual Report or Audited Financial Statements has been provided pursuant to this Disclosure Agreement, stating the date(s) it was provided and listing all Repositories with which it was filed.

(e) All documents, reports, notices, statements, information and other materials provided to the MSRB under this Disclosure Agreement shall be provided in an EMMA Compliant Format.

4. **Content of Annual Reports.**

(a) Each Annual Report shall be in the form set in Schedule A attached hereto and shall contain the following Annual Financial Information with respect to the Issuer:

(i) All fund balances in all Funds, Accounts and subaccounts for the Bonds and the total amount of Bonds Outstanding, in each case as of December 31st following the end of the most recent prior Fiscal Year.

(ii) The method by which Assessments are being levied (whether on-roll or off-roll) and the amounts being levied by each method in the Assessment Area for the current Fiscal Year, and a copy of the assessment roll (on roll and off roll) for the Assessments certified for collection in the Assessment Area for the current Fiscal Year.

(iii) The method by which Assessments were levied (whether on-roll or off-roll) and the amounts levied by each method in the Assessment Area for the most recent prior Fiscal Year.

(iv) The amount of Assessments collected in the Assessment Area from the property owners during the most recent prior Fiscal Year.

(v) If available, the amount of delinquencies in the Assessment Area greater than one hundred fifty (150) days, and, in the event that delinquencies amount to more than ten percent (10%) of the amounts of the Assessments due in any year, a list of delinquent property owners.

(vi) If available, the amount of tax certificates sold for lands within the Assessment Area, if any, and the balance, if any, remaining for sale from the most recent Fiscal Year.

(vii) The amount of principal and interest to be paid on the Bonds in the current Fiscal Year.

(viii) The most recent Audited Financial Statements of the Issuer.

(ix) In the event of any amendment or waiver of a provision of this Disclosure Agreement, a description of such amendment or waiver in the next Annual Report, and in each case shall include, as applicable, a narrative explanation of the reason for the amendment or waiver and its impact on the type (or, in the case of a change in accounting principles, on the presentation) of financial information or operating data being presented by the Issuer. In addition, if the amendment relates to the accounting principles to be followed in preparing financial statements: (i) notice of such change shall be given in the same manner as for a Listed Event under Section 6(b); and (ii) the Annual Report for the year in which the change is made should present a comparison (in narrative form and also, if feasible, in quantitative form) between the financial statements as prepared on the basis of the new accounting principles and those prepared on the basis of the former accounting principles.

To the extent any of the items set forth in subsections (i) through (vii) above are included in the Audited Financial Statements referred to in subsection (viii) above, they do not have to be separately set forth (unless Audited Financial Statements are being delivered later than March 31st after the close of the Issuer's Fiscal Year pursuant to Section 3(a) hereof). Any or all of the items listed above may be incorporated by reference from other documents, including limited offering memorandums and official statements of debt issues of the Issuer or related public entities, which have been submitted to the MSRB or the SEC. If the document incorporated by reference is a final limited offering memorandum or official statement, it must be available from the MSRB. The Issuer shall clearly identify each such other document so incorporated by reference.

(b) Any Annual Financial Information containing modified operating data or financial information is required to explain, in narrative form, the reasons for the modification and the impact of the change in the type of operating data or financial information being provided.

5. **Quarterly Reports.**

(a) Each Obligated Person (other than the Issuer), or the Developer on behalf of any other Obligated Person that fails to execute an Assignment (as hereinafter defined), shall provide an electronic copy of the Quarterly Report to the Dissemination Agent no later than five (5) days prior to the Quarterly Filing Date. Promptly upon receipt of an electronic copy of the Quarterly Report, but in any event no later than the applicable Quarterly Filing Date, the Dissemination Agent shall provide a Quarterly Report to the Repository.

(b) Each Quarterly Report shall contain an update of the following information to the extent available with respect to the Assessment Area only:

(i) The number and type of lots planned.

Lot Ownership Information

- (ii) The number of lots owned by the Developer.
- (iii) The number of lots owned by homebuilders. (Note: if the Developer and the homebuilder are the same entity, then only report the info in (ii).)
- (iv) The number of lots owned by homebuyers.

Lot Status Information

- (v) The number of lots developed.
- (vi) The number of lots platted.

Home Sales Status Information

- (vii) The number of homes sold (but not closed) with homebuyers, during quarter.
- (viii) The number of homes sold (and closed) with homebuyers, during quarter.
- (ix) The total number of homes sold and closed with homebuyers (cumulative).

Material Changes/Transfers

(x) Material changes to any of the following: (1) builder contracts, if applicable, (2) the number of lots planned to be developed, (3) permits/approvals, and (4) existing mortgage debt of the Obligated Person or the incurrence of new mortgage debt by the Obligated Person since the date hereof.

(xi) Any sale, assignment or transfer of ownership of lands by the Obligated Person to a third party which will in turn become an Obligated Person hereunder.

(c) If an Obligated Person sells, assigns or otherwise transfers ownership of real property in the Assessment Area (a "Transferor Obligated Person") to a third party (a "Transferee"), which will in turn be an Obligated Person for purposes of this Disclosure Agreement as a result thereof (a "Transfer"), the Transferor Obligated Person hereby agrees to use its best efforts to contractually obligate such Transferee to agree to comply with the disclosure obligations of an Obligated Person hereunder for so long as such Transferee is an Obligated Person hereunder, to the same extent as if such Transferee were a party to this Disclosure Agreement (an "Assignment"). The Transferor Obligated Person shall notify the District and the Dissemination Agent in writing of any Transfer within five (5) Business Days of the occurrence thereof. Nothing herein shall be construed to relieve the Developer from its obligations hereunder except to the extent a written Assignment from a Transferee is obtained and delivered to the Dissemination Agent and then only to the extent of such Assignment.

6. **Reporting of Listed Events.**

(a) This Section 6 shall govern the giving of notices of the occurrence of any of the following Listed Events:

- (i) Principal and interest payment delinquencies;
- (ii) Non-payment related defaults, if material;
- (iii) Unscheduled draws on the Assessment Area One Reserve Account reflecting financial difficulties;
- (iv) Unscheduled draws on credit enhancements reflecting financial difficulties;*
- (v) Substitution of credit or liquidity providers, or their failure to perform;*
- (vi) Adverse tax opinions, the issuance by the Internal Revenue Service of proposed or final determinations of taxability, Notices of Proposed Issue (IRS Form 5701-TEB) or other material notices or determinations with respect to the tax status of the Bonds, or other material events affecting the tax status of the Bonds;
- (vii) Modifications to rights of Bond holders, if material;
- (viii) Bond calls, if material, and tender offers;
- (ix) Defeasances;
- (x) Release, substitution, or sale of property securing repayment of the Bonds, if material;
- (xi) Rating changes;*
- (xii) Bankruptcy, insolvency, receivership or similar event of the Issuer or any Obligated Person (which is considered to occur when any of the following occur: the appointment of a receiver, fiscal agent or similar officer for the Issuer or any Obligated Person in a proceeding under the U.S. Bankruptcy Code or in any other proceeding under state or federal law in which a court or governmental authority has assumed jurisdiction over substantially all of the assets or business of the Issuer or any Obligated Person, or if such jurisdiction has been assumed by leaving the existing governing body and officials or officers in possession but subject to the supervision and orders of a court or governmental authority, or the entry of an order confirming a plan of reorganization, arrangement or liquidation by a court or governmental authority having supervision or jurisdiction over substantially all of the assets or business of the Issuer or any Obligated Person);

* Not applicable to the Bonds at their date of issuance.

(xiii) Consummation of a merger, consolidation, or acquisition involving the Issuer or any Obligated Person or the sale of all or substantially all of the assets of the Issuer or any Obligated Person, other than in the ordinary course of business, the entry into a definitive agreement to undertake such an action or the termination of a definitive agreement relating to any such actions, other than pursuant to its terms, if material;

(xiv) Appointment of a successor or additional Trustee or the change of name of the Trustee, if material;

(xv) Incurrence of a Financial Obligation of the Issuer or Obligated Person, if material, or agreement to covenants, events of default, remedies, priority rights, or other similar terms of a Financial Obligation of the Issuer or Obligated Person, any of which affect security holders, if material;

(xvi) Default, event of acceleration, termination event, modification of terms, or other similar events under the terms of the Financial Obligation of the Issuer or Obligated Person, any of which reflect financial difficulties;

(xvii) Failure to provide (A) any Annual Report or Audited Financial Statements as required under this Disclosure Agreement that contains, in all material respects, the information required to be included therein under Section 4(a) of this Disclosure Agreement, or (B) any Quarterly Report that contains, in all material respects, the information required to be included therein under Section 5(b) of this Disclosure Agreement, which failure shall, in all cases, be deemed material under federal securities laws; and

(xviii) Any amendment to the accounting principles to be followed in preparing financial statements as required pursuant to Section 4(a)(ix) hereof.

(b) The Issuer shall give, or cause to be given, notice of the occurrence of any of the above subsection (a) Listed Events to the Dissemination Agent in writing in sufficient time in order to allow the Dissemination Agent to file notice of the occurrence of such Listed Event in a timely manner not in excess of ten (10) Business Days after its occurrence, with the exception of the Listed Events described in Section 6(a)(xvii) and (xviii), which notice will be given in a timely manner. Such notice shall instruct the Dissemination Agent to report the occurrence pursuant to subsection (d) below. Such notice by the Issuer to the Dissemination Agent shall identify the Listed Event that has occurred, include the text of the disclosure that the Issuer desires to make, contain the written authorization of the Issuer for the Dissemination Agent to disseminate such information, and identify the date the Issuer desires for the Dissemination Agent to disseminate the information (provided that such date is in compliance within the filing dates provided within this Section 6(b)).

(c) Notwithstanding anything contained in Section 6(b) above, each Obligated Person other than the Issuer shall notify the Issuer and the Dissemination Agent of the occurrence of a Listed Event described in subsections (a)(x), (xii), (xiii), (xv), (xvi), or (xvii) that has occurred with respect to such Obligated Person in compliance with the notification and filing requirements provided in Section 6(b).

(d) If the Dissemination Agent has been instructed by the Issuer to report the occurrence of a Listed Event, the Dissemination Agent shall immediately file a notice of such occurrence with each Repository.

7. **Termination of Disclosure Agreement.** This Disclosure Agreement shall terminate upon the defeasance, prior redemption or payment in full of all of the Bonds.

8. **Dissemination Agent.** Upon termination of the Dissemination Agent's services as Dissemination Agent, whether by notice of the Issuer or the Dissemination Agent, the Issuer agrees to appoint a successor Dissemination Agent or, alternatively, agrees to assume all responsibilities of Dissemination Agent under this Disclosure Agreement for the benefit of the Holders of the Bonds. If at any time there is not any other designated Dissemination Agent, the District shall be deemed to be the Dissemination Agent. The initial Dissemination Agent shall be Governmental Management Services – Central Florida, LLC. The acceptance of such designation is evidenced by the execution of this Disclosure Agreement by a duly authorized signatory of Governmental Management Services – Central Florida, LLC. Governmental Management Services – Central Florida, LLC, may terminate its role as Dissemination Agent at any time upon delivery of sixty (60) days prior written notice to the District and each Obligated Person. The District may terminate the agreement hereunder with the Dissemination Agent at any time upon delivery of sixty (60) days prior written notice to the Dissemination Agent and each Obligated Person.

9. **Amendment; Waiver.** Notwithstanding any other provision of this Disclosure Agreement, the Issuer and the Dissemination Agent may amend this Disclosure Agreement, and any provision of this Disclosure Agreement may be waived, if such amendment or waiver is supported by an opinion of counsel expert in federal securities laws, acceptable to the Issuer, to the effect that such amendment or waiver would not, in and of itself, cause the undertakings herein to violate the Rule if such amendment or waiver had been effective on the date hereof but taking into account any subsequent change in or official interpretation of the Rule.

Notwithstanding the above provisions of this Section 9, no amendment to the provisions of Section 5(b) hereof may be made without the consent of each Obligated Person, if any.

10. **Additional Information.** Nothing in this Disclosure Agreement shall be deemed to prevent the Issuer from disseminating any other information, using the means of dissemination set forth in this Disclosure Agreement or any other means of communication, or including any other information in any Annual Report or notice of occurrence of a Listed Event, in addition to that which is required by this Disclosure Agreement. If the Issuer chooses to include any information in any Annual Report or notice of occurrence of a Listed Event in addition to that which is specifically required by this Disclosure Agreement, the Issuer shall have no obligation under this Disclosure Agreement to update such information or include it in any future Annual Report or notice of occurrence of a Listed Event.

11. **Default.** In the event of a failure of the Issuer, the Disclosure Representative, any Obligated Person or the Dissemination Agent to comply with any provision of this Disclosure Agreement, the Trustee may (and, at the request of any Participating Underwriter or the Beneficial Owners of at least twenty-five percent (25%) aggregate principal amount of Outstanding Bonds and receipt of indemnity satisfactory to the Trustee, shall), or any beneficial owner of a Bond may

take such actions as may be necessary and appropriate, including seeking mandamus or specific performance by court order, to cause the Issuer, the Disclosure Representative, any Obligated Person or a Dissemination Agent, as the case may be, to comply with its obligations under this Disclosure Agreement. A default under this Disclosure Agreement by any Obligated Person shall not be deemed a default by the Issuer hereunder and no default hereunder shall be deemed an Event of Default under the Indenture, and the sole remedy under this Disclosure Agreement in the event of any failure of the Issuer, the Disclosure Representative, any Obligated Person, or a Dissemination Agent, to comply with this Disclosure Agreement shall be an action to compel performance.

12. **Duties of Dissemination Agent.** The Dissemination Agent shall have only such duties as are specifically set forth in this Disclosure Agreement between the District, the Developer and such Dissemination Agent. The Dissemination Agent shall have no obligation to notify any other party hereto of an event that may constitute a Listed Event. The District, each Obligated Person and the Disclosure Representative covenant that they will supply, in a timely fashion, any information reasonably requested by the Dissemination Agent that is necessary in order for the Dissemination Agent to carry out its duties under this Disclosure Agreement. The District, each Obligated Person and the Disclosure Representative acknowledge and agree that the information to be collected and disseminated by the Dissemination Agent will be provided by the District, Obligated Person(s), the Disclosure Representative and others. The Dissemination Agent's duties do not include authorship or production of any materials, and the Dissemination Agent shall have no responsibility hereunder for the content of the information provided to it by the District, any Obligated Person or the Disclosure Representative as thereafter disseminated by the Dissemination Agent. Any filings under this Disclosure Agreement made to the MSRB through EMMA shall be in an EMMA Compliant Format.

13. **Beneficiaries.** This Disclosure Agreement shall inure solely to the benefit of the Issuer, the Developer, the Dissemination Agent, the Trustee, the Participating Underwriter and the Owners of the Bonds (the Dissemination Agent, the Trustee, Participating Underwriter and Owners of the Bonds being hereby deemed express third party beneficiaries of this Disclosure Agreement), and shall create no rights in any other person or entity.

14. **Tax Roll and Budget.** Upon the request of the Dissemination Agent, the Trustee or any Bondholder, the Issuer, through its District Manager, if applicable, agrees to provide such party with a certified copy of its most recent tax roll provided to the Osceola County Tax Collector and the Issuer's most recent adopted budget.

15. **Governing Law.** The laws of the State of Florida and Federal law shall govern this Disclosure Agreement and venue shall be any state or federal court having jurisdiction in Osceola County, Florida.

16. **Counterparts.** This Disclosure Agreement may be executed in several counterparts and each of which shall be considered an original and all of which shall constitute but one and the same instrument. A scanned copy of the signatures delivered in a PDF format may be relied upon as if the original had been received.

17. **Trustee Cooperation.** The Issuer represents that the Dissemination Agent is a bona fide agent of the Issuer and the Issuer instructs the Trustee to deliver to the Dissemination Agent at the expense of the Issuer, any information or reports readily available to and in the possession of the Trustee that the Dissemination Agent requests in writing.

18. **Binding Effect.** This Disclosure Agreement shall be binding upon each party to this Disclosure Agreement and upon each successor and assignee of each party to this Disclosure Agreement and shall inure to the benefit of, and be enforceable by, each party to this Disclosure Agreement and each successor and assignee of each party to this Disclosure Agreement. Notwithstanding the foregoing, as to the Developer or any assignee or successor thereto that becomes an Obligated Person pursuant to the terms of this Disclosure Agreement, only successors or assignees to such parties who are, by definition, Obligated Persons, shall be bound or benefited by this Disclosure Agreement.

[Signature Page Follows]

IN WITNESS WHEREOF, the undersigned has executed this Disclosure Agreement as of the date and year set forth above.

**HICKORY TREE COMMUNITY
DEVELOPMENT DISTRICT, AS ISSUER**

[SEAL]

By: _____
Chairperson, Board of Supervisors

ATTEST:

By: _____
Secretary

**CLAYTON PROPERTIES GROUP, INC., AS
DEVELOPER**

By: _____
_____, Manager

**GOVERNMENTAL MANAGEMENT
SERVICES – CENTRAL FLORIDA, LLC, and
its successors and assigns, AS DISSEMINATION
AGENT**

By: _____
Name: _____
Title: _____

CONSENTED TO AND AGREED TO BY:

DISTRICT MANAGER

**GOVERNMENTAL MANAGEMENT
SERVICES – CENTRAL FLORIDA,
LLC, AS DISTRICT MANAGER**

By: _____
Name: _____
Title: _____

Acknowledged and agreed to for purposes of
Sections 11, 13 and 17 only:

**U.S. BANK TRUST COMPANY, NATIONAL
ASSOCIATION, AS TRUSTEE**

By: _____

Name: _____

Title: _____

EXHIBIT A

**FORM OF NOTICE TO REPOSITORIES OF FAILURE
TO FILE [ANNUAL REPORT]
[AUDITED FINANCIAL STATEMENTS][QUARTERLY REPORT]**

Name of Issuer: Hickory Tree Community Development District

Name of Bond Issue: \$[] original aggregate principal amount of Special Assessment Bonds, Series 2023 (Assessment Area One Project)

Obligated Person(s): Hickory Tree Community Development District;
_____.

Original Date of Issuance: [], 2023

CUSIP Numbers: _____

NOTICE IS HEREBY GIVEN that the [Issuer][Obligated Person] has not provided an [Annual Report] [Audited Financial Statements] [Quarterly Report] with respect to the above-named Bonds as required by [Section 3] [Section 5] of the Continuing Disclosure Agreement dated [], 2023, by and between the Issuer, the Developer and the Dissemination Agent named therein. The [Issuer][Obligated Person] has advised the undersigned that it anticipates that the [Annual Report] [Audited Financial Statements] [Quarterly Report] will be filed by _____, 20____.

Dated: _____

_____, as Dissemination Agent

By: _____
Name: _____
Title: _____

cc: Issuer
Trustee

SCHEDULE A

FORM OF DISTRICT'S ANNUAL REPORT (Due 3/31)

1. Fund Balances

Combined Trust Estate Assets	<u>Quarter Ended – 12/31</u>
Acquisition and Construction Fund	
Revenue Fund	
Reserve Fund	
Prepayment Fund	
Other	
Total Bonds Outstanding	
TOTAL	

2. Assessment Certification and Collection Information

1. For the Current District Fiscal Year – Manner in which Assessments are collected (On Roll vs. Off Roll)

	<u>\$ Certified</u>
On Roll	\$ _____
Off Roll	\$ _____
TOTAL	\$ _____

2. Attach to Report the following:

- A. On Roll – Copy of certified assessment roll for the District's current Fiscal Year
- B. Off Roll – List of folios and ownership for all off roll Assessments, together with par and annual Assessment assigned to each folio

3. For the immediately ended Bond Year, provide the levy and collection information

<u>Total Levy</u>	<u>\$ Levied</u>	<u>\$ Collected</u>	<u>% Collected</u>	<u>% Delinquent</u>
On Roll	\$ _____	\$ _____	____%	____%
Off Roll	\$ _____	\$ _____	____%	____%
TOTAL				

4. If available, the amount of delinquencies in the Assessment Area greater than one hundred fifty (150) days, and, in the event that delinquencies amount to more than ten percent (10%) of the amount of the Assessments due in any year, a list of delinquent property owners

5. If available, the amount of tax certificates sold for lands within the Assessment Area, if any, and the balance, if any, remaining for sale from the most recent Fiscal Year

6. The amount of principal and interest to be paid on the Bonds in the current Fiscal Year

SECTION VII

SECTION A

This instrument was prepared by and upon recording should be returned to:

Jennifer Kilinski, Esq.
KILINSKI | VAN WYK PLLC
517 East College Avenue
Tallahassee Florida 32301

AGREEMENT BY AND BETWEEN THE HICKORY TREE COMMUNITY DEVELOPMENT DISTRICT AND CLAYTON PROPERTIES GROUP, INC. REGARDING THE TRUE-UP AND PAYMENT OF ASSESSMENTS

THIS TRUE-UP AGREEMENT (“Agreement”) is made and entered into this ____ day of _____, 2023, by and between:

HICKORY TREE COMMUNITY DEVELOPMENT DISTRICT, a local unit of special-purpose government established pursuant to Chapter 190, *Florida Statutes*, being situated in Osceola County, Florida, whose address is c/o Governmental Management Services – Central Florida, LLC, 219 East Livingston Street, Orlando, Florida 32801 (the “District”), and

CLAYTON PROPERTIES GROUP, INC., a Tennessee corporation, the developer and owner of certain lands within the District, with offices located at 3020 South Florida Avenue, Suite 101, Lakeland, Florida, 33803 (together with its successors and assigns, the “**Landowner**”).

RECITALS

WHEREAS, the District was established by ordinance enacted by the Board of County Commissioners in and for Osceola County, Florida, pursuant to the Uniform Community Development District Act of 1980, Chapter 190, *Florida Statutes*, as amended (the “**Act**”), for the purpose of planning, financing, constructing, acquiring, operating and/or maintaining certain public infrastructure improvements within or without the boundary of the District; and

WHEREAS, the Act authorizes the District to issue bonds for the purposes, among others, of planning, financing, constructing, operating and/or maintaining certain public infrastructure, including but not limited to stormwater management facilities, roadways, water and sewer utilities, underground electric, off-site improvements, entry features, landscape and hardscape, irrigation, and other infrastructure within or without the boundaries of the District; and

WHEREAS, Landowner is the owner and the developer of certain lands in Osceola County, Florida, located within the boundaries of the District, which property description is attached hereto as **Exhibit A** and is incorporated herein by this reference (the “**Assessment Area One**”); and

WHEREAS, a Final Judgment was issued on December 20, 2022, validating the authority of the District to issue up to \$53,090,000 in aggregate principal amount of Hickory Tree Community Development District Special Assessment Bonds in one or more series (the “**Bonds**”) to finance the design, acquisition, construction, installation, of community development facilities,

services and improvements within and without the boundaries of the District as authorized by the Act and as set forth in the District's previously adopted *Hickory Tree Community Development District Engineer's Report*, dated June 28, 2022 (the "**Master Engineer's Report**" and the improvements detailed therein, the "**Capital Improvement Plan**"), as supplemented by that certain *Hickory Tree Community Development District Supplemental Engineer's Report (Assessment Area One)*, dated September 6, 2023 ("**Supplemental Engineer's Report**" and the project detailed therein, the "**Assessment Area One Project**" and together with the Master Engineer's Report, the "**Engineer's Report**"); and

WHEREAS, the District is presently in the process of issuing \$ _____ of Hickory Tree Community Development District Special Assessment Bonds, Series 2023 ("**Assessment Area One Bonds**") to finance a portion of the design, construction or acquisition of the Capital Improvement Plan, including the Assessment Area One Project; and

WHEREAS, pursuant to Resolutions 2022-27, 2022-28, 2022-36 and 2023-08 (the "**Assessment Resolutions**"), the District has imposed special assessments on Assessment Area One (the "**Assessment Area One Assessments**") within the District to secure the repayment of a portion of the Assessment Area One Bonds, including interest thereon; and

WHEREAS, Landowner agrees that all developable lands within Assessment Area One benefit from the timely design, construction, or acquisition of the Assessment Area One Project; and

WHEREAS, Landowner agrees that the Assessment Area One Assessments which were imposed on Assessment Area One within the District, have been validly imposed and constitute valid, legal and binding liens upon Assessment Area One, which Assessment Area One Assessments remain unsatisfied; and

WHEREAS, to the extent permitted by law, Landowner waives any defect in notice or publication or in the proceedings to levy, impose and collect the Assessment Area One Assessments on Assessment Area One within the District; and

WHEREAS, the *Master Assessment Methodology for Hickory Tree Community Development District*, dated June 28, 2022 ("**Master Assessment Report**"), as supplemented by that *First Supplemental Assessment Methodology (Assessment Area One Project)*, dated September 6, 2023 ("**Supplemental Assessment Report**", together with the Master Assessment Report, the "**Assessment Report**"), provides that as Assessment Area One is platted or re-platted, the allocation of the amounts assessed to and constituting a lien upon Assessment Area One within the District would be allocated and calculated based upon certain density assumptions relating to the number of each type of residential units to be constructed on Assessment Area One within the District, which assumptions were provided by Landowner; and

WHEREAS, Landowner intends that Assessment Area One within the District will be platted, planned and developed based on then-existing market conditions, and the actual densities developed may be at some density less than the densities assumed in the District's Supplemental Assessment Report; and

WHEREAS, the District's Supplemental Assessment Report anticipates a mechanism by which Landowner shall, if required, make certain payments to the District in order to satisfy, in whole or in part, the assessments allocated and the liens imposed pursuant to the Assessment Resolutions, the amount of such payments being determined generally by a calculation of the remaining unallocated debt prior to the recording of any plat or site plan for a parcel or tract, as described in the District's Supplemental Assessment Report (which payments shall collectively be referenced as the "**True-Up Payment**"); and

WHEREAS, Landowner and the District desire to enter into an agreement to confirm Landowner's intention and obligation, if required, to make the True-Up Payment related to the Assessment Area One Assessments, subject to the terms and conditions contained herein.

NOW, THEREFORE, based upon good and valuable consideration and the mutual covenants of the Parties, the receipt and sufficiency of which are hereby acknowledged, the Parties agree as follows:

SECTION 1. RECITALS. The recitals stated above are true and correct and by this reference are incorporated into and form a material part of this Agreement.

SECTION 2. COVENANTS.

A. The provisions of this Agreement shall constitute a covenant running with Assessment Area One lands, which lands are described herein in **Exhibit A**, and shall remain in full force and effect and be binding upon Landowner, its heirs, legal representatives, estates, successors, grantees and assigns until released pursuant to the terms herein.

B. Landowner agrees that to the extent Landowner fails to timely pay all Assessment Area One Assessments collected by mailed notice of the District, said unpaid Assessment Area One Assessments (including True-Up Payments), may be placed on the tax roll by the District for collection by the Tax Collector pursuant to Section 197.3632, *Florida Statutes*, in any subsequent year.

SECTION 3. SPECIAL ASSESSMENT REALLOCATION.

A. *Assumptions as to the Assessment Area One Assessments.* As of the date of the execution of this Agreement, Landowner has informed the District that Landowner intends to plat Assessment Area One into a total of 406 residential lots or 406 Equivalent Residential Units ("**ERUs**").

B. *Process for Reallocation of Assessments.* The Assessment Area One Assessments will be reallocated among Assessment Area One as Assessment Area One is platted or re-platted (hereinafter referred to as "plat" or "platted"). In connection with such platting of Assessment Area One of the District, the Assessment Area One Assessments imposed on the lands being platted will be allocated based upon the precise number and type of lots within the area being platted. It is intended that all the Assessment Area One Assessments will be assigned to the 406 lots platted in Assessment Area One. In furtherance thereof, at such time as Assessment Area One is to be platted, Landowner covenants that such plat or plats shall be presented to the District. The

District shall allocate the Assessment Area One Assessments to the number of lots being platted and the remaining lands in Assessment Area One in accordance with the District's Assessment Report and cause such reallocation to be recorded in the District's Improvement Lien Book.

(i) It is or will be an express condition of the liens established by the Assessment Resolutions that any and all plats containing any portion of Assessment Area One within the District owned by Landowner shall be presented to the District for review and allocation of the Assessment Area One Assessments to the lots being platted and the remaining property within Assessment Area One in accordance with the Assessment Report ("Reallocation"). Landowner covenants to comply with this requirement for the Reallocation. The District agrees that no further action by the Board of Supervisors shall be required. The District's review of the plats shall be limited solely to the Reallocation of Assessment Area One Assessments and enforcement of the District's assessment liens. Nothing herein shall in any way operate to or be construed as providing any other plat and plan approval or disapproval powers to the District.

(ii) The purpose of the True-Up calculation is to ensure that the bond debt will be able to be assigned to at least 406 platted lots within Assessment Area One of the District. Thus, at the time of platting of any portion of Assessment Area One, or any replatting thereof, there must be at least 406 platted lots in Assessment Area One to assign the bond debt to. If not, subject to subsection (v) below, the District would require a True-Up Payment from Landowner or the person or entity seeking to file such plat in an amount sufficient to reduce the remaining bond debt to the actual number of lots platted in Assessment Area One in the par amount per platted lot as set forth in the Assessment Report.

(iii) The True-Up calculation shall be performed at the time any portion of Assessment Area One is platted.

(iv) If at the time the True-Up calculation is performed, it is determined that less than 406 lots are to be platted within Assessment Area One, a True-Up Payment shall become immediately due and payable. Any such True-Up Payment determined to be due shall be paid in full prior to approval of the plat. Such True-Up Payment shall be in addition to the regular Assessment Area One installment payable for Assessment Area One. The District will take all necessary steps to ensure that True-Up Payments are made in a timely fashion to ensure its debt service obligations are met, and in all cases, Landowner agrees that such payments shall be made in order to ensure the District's timely payment of the debt service obligations on the Assessment Area One Bonds. The District shall record all True-Up Payments in its Improvement Lien book. If such True-Up Payment is made at least forty-five (45) days prior to an interest payment date on the Assessment Area One Bonds, Landowner shall include accrued interest as part of the True-Up Payment to such interest payment date. If such True-Up Payment becomes due within forty-five (45) days of the next interest payment date, accrued interest shall be calculated to the next succeeding interest payment date.

(v) The foregoing is based on the District's understanding with Landowner that at least 406 ERUs will be assigned to Assessment Area One, as identified in the Assessment Report and Engineer's Report. However, the District agrees that nothing herein prohibits

more or less than the anticipated number of ERUs to be assigned to Assessment Area One. In the event Landowner plats less than 406 lots within Assessment Area One, the Landowner may either make a True-Up Payment or leave unassigned Assessment Area One Assessments on un-platted lands within Assessment Area One, provided the maximum debt allocation per developable acre as set forth in the Assessment Resolution is not exceeded. In no event shall the District collect Assessment Area One Assessments pursuant to the Assessment Resolutions in excess of the total debt service related to the Assessment Area One Project, including all costs of financing and interest. The District, however, may collect Assessment Area One Assessments in excess of the annual debt service related to the Assessment Area One Project, including all costs of financing and interest, which shall be applied to prepay the Assessment Area One Bonds. If the strict application of the True-Up methodology to any Reallocation for any plat pursuant to this paragraph would result in Assessment Area One Assessments collected in excess of the District's total debt service obligation for the Assessment Area One Project, the District agrees to take appropriate action by resolution to equitably Reallocate the assessments.

SECTION 4. ENFORCEMENT. This Agreement is intended to be an additional method of enforcement of Landowner's obligation to pay the Assessment Area One Assessments and to abide by the requirements of the Reallocation of Assessment Area One Assessments, including the making of the True-Up Payment, if any, as set forth in the Assessment Resolutions. A default by any Party under this Agreement shall entitle any other Party to all remedies available at law or in equity, but excluding special, consequential or punitive damages.

SECTION 5. RECOVERY OF COSTS AND FEES. In the event any Party is required to enforce this Agreement by court proceedings or otherwise, then the substantially prevailing party, as determined by the applicable court or other dispute resolution provider, shall be entitled to recover from the other(s) all fees and costs incurred, including reasonable attorneys' fees and costs incurred prior to or during any litigation or other dispute resolution and including all fees and costs incurred in appellate proceedings.

SECTION 6. NOTICE. All notices, requests, consents and other communications hereunder ("Notices") shall be in writing and shall be delivered, mailed by First Class Mail, postage prepaid, by overnight delivery service, or electronic or hand delivered to the Parties, as follows:

A. If to the District: Hickory Tree Community Development District
c/o Governmental Management Services – Central
Florida, LLC
219 East Livingston Street
Orlando, Florida 32801
Attn: District Manager

With a copy to: Kilinski | Van Wyk PLLC
517 East College Avenue
Tallahassee, Florida 32301
Attn: District Counsel

B. If to the Landowner: Clayton Properties Group, Inc.
3020 South Florida Avenue, Suite 101
Lakeland, Florida 33803
Attn: D. Joel Adams

Except as otherwise provided herein, any Notice shall be deemed received only upon actual delivery at the address or telecopy number set forth herein. If mailed as provided above, Notices shall be deemed delivered on the third business day unless actually received earlier. Notices hand delivered after 5:00 p.m. (at the place of delivery) or on a non-business day, shall be deemed received on the next business day. If any time for giving Notice contained in this Agreement would otherwise expire on a non-business day, the Notice period shall be extended to the next succeeding business day. Saturdays, Sundays and legal holidays recognized by the United States government shall not be regarded as business days. Counsel for the Parties may deliver Notice on behalf of the Parties. Any Party or other person to whom Notices are to be sent or copied may notify the other parties and addressees of any change in name, address or telecopy number to which Notices shall be sent by providing the same on five (5) days written notice to the parties and addressees set forth herein.

Notwithstanding the foregoing, to the extent Florida law requires notice to enforce the collection of any assessments placed on Assessment Area One by the District, then the provision of such notice shall be in lieu of any additional notice required by this Agreement.

SECTION 7. ASSIGNMENT.

A. Landowner may not assign its duties or obligations under this Agreement except in accordance with the terms of this Section 7(C) below. This Agreement shall constitute a covenant running with title to all or any portion of Assessment Area One, binding upon Landowner and its successors and assigns including, without limitation, any purchaser and its successors and assigns as to Assessment Area One or portions thereof, and any transferee of any portion of Assessment Area One, but shall not be binding upon transferees permitted by Sections 7(B)(i), (ii) or (iii) below.

B. No portion of Assessment Area One may be transferred to any third party without complying with the terms of Section 7(C) below, other than:

- (i)** Platted and fully-developed lots to homebuilders restricted from re-platting.
- (ii)** Platted and fully-developed lots to end users.

(iii) Portions of Assessment Area One exempt from debt special assessments or to be dedicated to Osceola County, Florida, the District or other governmental agencies. Any transfer of any portion of Assessment Area One pursuant to subsections (i), (ii) or (iii) of this Section 7(B), shall constitute an automatic release of such portion of Assessment Area One from the scope and effect of this Agreement.

C. Landowner shall not transfer any portion of Assessment Area One to any third party, except as permitted by Sections 7(B)(i), (ii) or (iii) above, without satisfying the following conditions (the “Transfer Conditions”):

- (i) delivering a recorded copy of this Agreement to such third party; and
- (ii) satisfying any True-Up Payment that results from a True-Up analysis that will be performed by the District Manager prior and as a condition to such transfer.

Any transfer that is consummated pursuant to this Section 7(C) shall operate as a release of Landowner from its obligations under this Agreement as to such portion of Assessment Area One only arising from and after the date of such transfer and satisfaction of all of the Transfer Conditions including payment of any True-Up Payment due pursuant to subsection 7(C)(ii) above, and the transferee shall be deemed to have assumed Landowner’s obligations in accordance herewith and shall be deemed the “Landowner” from and after such transfer for all purposes as to such portion of Assessment Area One so transferred.

SECTION 8. AMENDMENT. This Agreement shall constitute the entire agreement between the Parties regarding the subject matter discussed herein and may be modified in writing only by the mutual agreement of all Parties. This Agreement may not be amended without the prior written consent of the Trustee on behalf and acting at the direction of the bondholders owning more than fifty percent (50%) of the aggregate principal amount of the applicable Assessment Area One Bonds then outstanding with regard to material amendments.

SECTION 9. AUTHORIZATION. The execution of this Agreement has been duly authorized by the appropriate body or official of the District and Landowner, both the District and Landowner have complied with all the requirements of law, and both the District and Landowner have full power and authority to comply with the terms and provisions of this Agreement.

SECTION 10. TERMINATION. This Agreement shall continue in effect until it is rescinded in writing by the mutual assent of each Party, provided, however, that this Agreement and the covenants contained herein may not be terminated or released prior to platting and development of all Assessment Area One without the prior written consent of the Trustee on behalf and acting at the direction of bondholders owning more than fifty percent (50%) of the aggregate principal amount of the applicable Assessment Area One Bonds then outstanding with regard to amendments having a material effect on the District’s ability to pay debt service on the Assessment Area One Bonds.

SECTION 11. NEGOTIATION AT ARM’S LENGTH. This Agreement has been negotiated fully between the Parties as an arm’s length transaction. The Parties participated fully in the preparation of this Agreement and received the advice of counsel. In the case of a dispute concerning the interpretation of any provision of this Agreement, The Parties are deemed to have drafted, chosen and selected the language, and the doubtful language will not be interpreted or construed against either Party.

SECTION 12. THIRD-PARTY BENEFICIARIES. This Agreement is solely for the benefit of the District and Landowner and no right or cause of action shall accrue upon or by reason, to or

for the benefit of any third party not a formal party to this Agreement. Except as provided in the immediately succeeding sentence, nothing in this Agreement expressed or implied is intended or shall be construed to confer upon any person or entity other than the District and Landowner any right, remedy or claim under or by reason of this Agreement or any provisions or conditions of this Agreement; and all of the provisions, representations, covenants and conditions contained in this Agreement shall inure to the sole benefit of and shall be binding upon the District and Landowner and their respective representatives, successors and assigns. Notwithstanding anything herein to the contrary, the Trustee for the Assessment Area One Bonds, on behalf of the owners of the Assessment Area One Bonds, shall be a direct third-party beneficiary of the terms and conditions of this Agreement and shall be entitled to enforce Landowner's obligations hereunder. The Trustee shall not be deemed to have assumed any obligations hereunder.

SECTION 13. LIMITATIONS ON GOVERNMENTAL LIABILITY. Nothing in this Agreement shall be deemed as a waiver of immunity or limits of liability of the District beyond any statutory limited waiver of immunity or limits of liability which may have been adopted by the Florida Legislature in Section 768.28, *Florida Statutes*, or other statute, and nothing in this Agreement shall inure to the benefit of any third party for the purpose of allowing any claim which would otherwise be barred under the Doctrine of Sovereign Immunity or by operation of law.

SECTION 14. APPLICABLE LAW AND VENUE. This Agreement and the provisions contained herein shall be construed, interpreted, and controlled according to the laws of the State of Florida. Each Party consents that the exclusive venue for any litigation arising out of or related to this Agreement shall be in a court of appropriate jurisdiction, in and for Osceola County, Florida.

SECTION 15. PUBLIC RECORDS. Landowner understands and agrees that all documents of any kind provided to the District in connection with this Agreement may be public records and may require treatment as such in accordance with Florida law.

SECTION 16. EXECUTION IN COUNTERPARTS. This instrument may be executed in any number of counterparts, each of which, when executed and delivered, shall constitute an original, and such counterparts together shall constitute one and the same instrument. Signature and acknowledgment pages, if any, may be detached from the counterparts and attached to a single copy of this document to physically form one document.

SECTION 17. SEVERABILITY. The invalidity or unenforceability of any one or more provisions of this Agreement shall not affect the validity or enforceability of the remaining portions of this Agreement, or any part of this Agreement not held to be invalid or unenforceable.

SECTION 18. EFFECTIVE DATE. This Agreement shall become effective after execution by the Parties hereto on the date reflected above.

[Remainder of Page Left Blank, Signature Pages Follow]

IN WITNESS WHEREOF, the Landowner and the District have caused this Agreement to be executed and delivered on the day and year first written above.

WITNESSES:

CLAYTON PROPERTIES GROUP, INC.,
a Tennessee corporation

Witness Signature
Printed name: _____

By: D. Joel Adams
Its: Vice President

Witness Signature
Printed name: _____

STATE OF FLORIDA)
COUNTY OF _____)

The foregoing instrument was acknowledged before me by means of physical presence or online notarization this ___ day of _____, 2023, by D. Joel Adams, as Vice President of **Clayton Properties Group, Inc.**, for and on behalf of said entity. He is personally known to me or produced _____ as identification.

NOTARY STAMP:

Signature of Notary Public

Printed Name of Notary Public

WITNESSES:

**HICKORY TREE COMMUNITY
DEVELOPMENT DISTRICT**

Witness Signature
Printed name: _____

Chairperson, Board of Supervisors

Witness Signature
Printed name: _____

STATE OF FLORIDA)
COUNTY OF _____)

The foregoing instrument was acknowledged before me by means of physical presence or online notarization this ____ day of _____, 2023, by Milton Andrade, as Chairperson of the Board of Supervisors of the Hickory Tree Community Development District, for and on behalf of the District. He is personally known to me or produced _____ as identification.

NOTARY STAMP:

Signature of Notary Public

Printed Name of Notary Public

Exhibit A: Legal Description of Assessment Area One

EXHIBIT A
LEGAL DESCRIPTION OF ASSESSMENT AREA ONE

SECTION B

This instrument was prepared by and upon recording should be returned to:

(This space reserved for Clerk)

Jennifer Kilinski, Esq.
KILINSKI | VAN WYK PLLC
517 East College Avenue
Tallahassee Florida 32301

COLLATERAL ASSIGNMENT AND ASSUMPTION OF DEVELOPMENT RIGHTS

THIS COLLATERAL ASSIGNMENT AND ASSUMPTION OF DEVELOPMENT RIGHTS (“Assignment”) is made this ____ day of _____ 2023, by and between:

CLAYTON PROPERTIES GROUP, INC., a Tennessee corporation, the developer and owner of certain lands within the District, with offices located at 3020 South Florida Avenue, Suite 101, Lakeland, Florida, 33803 (together with its successors and assigns, the “**Landowner**” or “**Assignor**”); and

HICKORY TREE COMMUNITY DEVELOPMENT DISTRICT, a local unit of special-purpose government established pursuant to Chapter 190, *Florida Statutes*, being situated in Osceola County, Florida, whose address is c/o Governmental Management Services – Central Florida, LLC, 219 East Livingston Street, Orlando, Florida 32801 (the “**District**” or “**Assignee**”).

RECITALS

WHEREAS, the District was established by ordinance adopted by the Board of County Commissioners in and for Osceola County, Florida, pursuant to the Uniform Community Development District Act of 1980, Chapter 190, *Florida Statutes*, as amended and for the purposes, among others, of planning, financing, constructing, operating and/or maintaining certain public infrastructure improvements; and

WHEREAS, Landowner is the owner and the developer of certain lands in Osceola County, Florida, located within the boundaries of the District, which property description is attached hereto as **Exhibit A** and is incorporated herein by this reference (“**Assessment Area One**”); and

WHEREAS, the District has adopted an improvement plan for the planning, design, acquisition, construction, and installation of certain infrastructure improvements, facilities and services within and without the boundaries of the District, which plan is detailed in its *Hickory Tree Community Development District Engineer’s Report*, dated June 28, 2022 (the “**Master Engineer’s Report**” and the improvements detailed therein, the “**Capital Improvement Plan**”), as supplemented by that certain *Hickory Tree Community Development District Supplemental Engineer’s Report (Assessment Area One)*, dated September 6, 2023 (“**Supplemental Engineer’s Report**” and the project detailed therein, the “**Assessment Area One Project**” and together with the Master Engineer’s Report, the “**Engineer’s Report**”); and

WHEREAS, the Capital Improvement Plan is estimated to cost a total amount of approximately \$40,958,855.15; and

WHEREAS, a Final Judgment was issued on December 20, 2022, validating the authority of the District to issue up to \$53,090,000 in aggregate principal amount of Hickory Tree Community Development District Special Assessment Bonds to finance certain improvements and facilities within and without the District boundaries; and

WHEREAS, the District is presently in the process of issuing \$ _____ of Hickory Tree Community Development District Special Assessment Bonds, Series 2023 (“**Assessment Area One Bonds**”) to finance a portion of the design, construction or acquisition of the Capital Improvement Plan (in connection with the issuance of the Assessment Area One Bonds, the Capital Improvement Plan is referred to as the “**Assessment Area One Project**”); and

WHEREAS, the Assessment Area One Project will benefit all lands within the District, as described in the District’s *Master Assessment Methodology for Hickory Tree Community Development District*, dated June 28, 2022 (“**Master Assessment Report**”), as supplemented by that certain *First Supplemental Assessment Methodology (Assessment Area One Project)*, dated September 6, 2023 (the “**Supplemental Assessment Report**” together with the Master Assessment Report, the “**Assessment Report**”); and

WHEREAS, the District has taken the steps necessary to impose special assessments upon the benefitted lands within the District pursuant to Chapters 170, 190 and 197, *Florida Statutes*, as security for the Assessment Area One Bonds; and

WHEREAS, the District's special assessments securing the Assessment Area One Bonds (“**Assessment Area One Assessments**”) will be imposed on all lands within the District as more specifically described in Resolutions 2022-27, 2022-28, 2022-36 and 2023-08 (collectively, “**Assessment Resolutions**”); and

WHEREAS, Landowner has acquired, or hereafter may acquire, certain rights (“**Development and Contract Rights**”) in, to, under, or by virtue of certain contracts, agreements, and other documents, which now or hereafter affect Assessment Area One or the Assessment Area One Project (collectively, “**Contract Documents**”); and

WHEREAS, the District and the Landowner anticipate development of Assessment Area One, and the allocation of Assessment Area One Assessments thereon, consistent with the Engineer’s Report and the Assessment Report until such time as the final platting of Assessment Area One (and the payment of any true-up amounts due and securing the Assessment Area One Bonds) is completed (“**Development Completion**”); and

WHEREAS, in the event of default in the payment of the Assessment Area One Assessments securing the Assessment Area One Bonds, the District has certain remedies with respect to the lien of the Assessment Area One Assessments as more particularly set forth herein, including certain foreclosure rights provided by Florida law (“**Remedial Rights**”); and

WHEREAS, as inducement to the District to issue the Assessment Area One Bonds, it is necessary to require the collateral assignment of the Development and Contract Rights for Assessment Area One to complete the Assessment Area One Project as anticipated by and at substantially the densities and intensities envisioned in the Supplemental Engineer's Report and the Supplemental Assessment Report; and

WHEREAS, this Assignment is not intended to impair or interfere with the development of the Assessment Area One Project, as anticipated by and at substantially the densities and intensities envisioned in the Supplemental Engineer's Report and the Supplemental Assessment Report and shall only be inchoate and shall become an effective and absolute assignment and assumption of the Development and Contract Rights upon failure of the Assignor to pay the Assessment Area One Assessments levied against Assessment Area One owned by the Assignor; provided, however, that such assignment shall only be effective and absolute to the extent that this Assignment has not been terminated earlier pursuant to the term of this Assignment; and

WHEREAS, in the event of a transfer, conveyance or sale of any portion of Assessment Area One, successors-in-interest (including successors in interest that are affiliates of Landowner) to Assessment Area One shall be subject to this Assignment, which shall be recorded in the Official Records of Osceola County, Florida, except as to Prior Transfers (defined below); and

WHEREAS, the rights assigned to the District hereunder shall be exercised in a manner which will not materially affect the intended development of the Assessment Area One Project; and

WHEREAS, absent this Assignment becoming effective and absolute, it shall automatically terminate upon the occurrence of certain events described herein.

NOW, THEREFORE, in consideration of the above recitals which the parties hereby agree are true and correct and are hereby incorporated by reference and other good and valuable consideration, the receipt and sufficiency of which are acknowledged, Assignor and Assignee agree as follows:

1. INCORPORATION OF RECITALS. The recitals stated above are true and correct and by this reference are incorporated as a material part of this Assignment.

2. COLLATERAL ASSIGNMENT.

(a) In the event of Assignor's default in the payment of the Assessment Area One Assessments securing the Assessment Area One Bonds, the Assignee shall be entitled to exercise its Remedial Rights to secure control and/or title to Assessment Area One. Such exercise of Remedial Rights by Assignee may include foreclosure proceedings, acceptance of a deed in lieu of foreclosure and the establishment of a special-purpose entity to hold title to Assessment Area One, as designee of the Assignee. The Assignor hereby agrees to unconditionally collaterally assign to Assignee or its designee, to the extent assignable, and to the extent that they are owned or controlled by Assignor, all of its Development and Contract Rights as security for Assignor's payment and performance and discharge of its obligation to pay the Assessment Area One

Assessments levied against Assessment Area One. Notwithstanding any contrary terms in this Assignment: the Development and Contract Rights exclude (x) any portion of the Development and Contract Rights which relates solely to lots which have been conveyed to end-users effective as of such conveyance, and (y) any portion of the Development and Contract Rights which relates solely to any portion of Assessment Area One which has been transferred, dedicated and/or conveyed, or is in the future conveyed, to Osceola County, Florida, Assignee, any utility provider, any governmental or quasi-governmental entity, any applicable homeowner's or property owner's association, or any other governing entity or association as may be required by the applicable permits, approvals, entitlements or regulations affecting the District, if any, and the Development and Contract Rights, in each case effective as of such transfer, conveyance and/or dedication, as applicable (each a "**Prior Transfer**"). Subject to the foregoing, the Development and Contract Rights shall include the items listed in subsections (i) through (ix), but not be limited to, the following:

- i. Any declaration of covenants of a homeowner's association governing Assessment Area One, as recorded in the Official Records of Osceola County, Florida, and as the same may be amended and restated from time to time, including, without limitation, all of the right, title, interest, powers, privileges, benefits and options of the "Landowner" or "Declarant" thereunder.
- ii. Engineering and construction plans and specifications for grading, traffic capacity analyses, roadways, site drainage, storm water drainage, signage, water distribution, wastewater collection, and other improvements to or affecting Assessment Area One.
- iii. Preliminary and final plats and/or site plans for Assessment Area One.
- iv. Architectural plans and specifications for buildings and other improvements to Assessment Area One, other than those associated with homebuilding and home construction.
- v. Permits, approvals, agreements, resolutions, variances, licenses, and franchises and applications therefor whether approved or in process pending before or granted by governmental authorities, or any of their respective agencies, for or affecting the development of Assessment Area One and construction of improvements thereon.
- vi. Contracts with engineers, architects, land planners, landscape architects, consultants, contractors, and suppliers for or relating to the development of Assessment Area One or the construction of improvements thereon, together with all warranties, guaranties and indemnities of any kind or nature associated therewith.
- vii. Franchise or other agreements for the provision of water and wastewater service to Assessment Area One, and all hookup fees and utility deposits

paid by Assignor in connection therewith.

- viii. Permit fees, impact fees, deposits and other assessments and impositions paid by Assignor to any governmental authority or utility and capacity reservations, impact fee credits and other credits due to Assignor from any governmental authority or utility provider, including credit for any dedication or contribution of Assessment Area One by Assignor in connection with the development of Assessment Area One or the construction of improvements thereon.
- ix. All future creations, changes, extensions, revisions, modifications, substitutions, and replacements of any of the foregoing and any guarantees of performance of obligations to Assignor arising thereunder by any means, including, but not limited to, pursuant to governmental requirements, administrative or formal action by third parties, or written agreement with governmental authorities or third parties.

(b) This Assignment is not intended to and shall not impair or interfere with the development of the District, and shall only be inchoate and shall become an effective and absolute assignment and assumption of the Development and Contract Rights upon failure of the Assignor to pay the Assessment Area One Assessments levied against Assessment Area One owned by the Assignor, if such failure remains uncured after passage of any applicable cure period; provided, however, that such assignment shall only be effective and absolute to the extent that this Assignment has not been terminated earlier pursuant to the term of this Assignment. Further, this Assignment is not intended to restrict nor shall it be construed as restricting Assignor's ability to assign Development and Contract Rights in the ordinary course of business, and the Assignor expressly retains the right and a license to use, enforce, sue upon, make claim under and upon and otherwise exercise all rights and remedies of the Assignor related to or arising from the Development and Contract Rights in the event an assignment of Development and Contract Rights under this Assignment becomes effective. However, to the extent the Landowner's exercise of rights set forth above causes the District to incur any cost, the Landowner agrees to pay such cost. Moreover, the Landowner agrees not to exercise any rights provided for herein in a manner adverse to the District's interests.

(c) If this Assignment has not become absolute, any portion not previously terminated and/or property released in connection with a Prior Transfer shall automatically terminate upon the earliest to occur of the following events (herein, the "Term"): (i) payment of the Assessment Area One Bonds in full; and (ii) Development Completion. At Landowner's request and the District's confirmation that the provisions of the foregoing have been satisfied, District and Landowner will record a notice or other appropriate instrument in the Public Records of Osceola County, Florida, confirming the end of the Term. Without limiting the foregoing, upon a Prior Transfer, the portion of Assessment Area One so transferred

shall be deemed released automatically from the terms, scope and encumbrance of this Assignment whether or not the Term has expired as to any other portion of Assessment Area One and without any written release or certification being required from the District or any other person or entity, and any transferee and title examiner may rely on the foregoing automatic release in insuring title to such portion of Assessment Area One so transferred without making exception for this Assignment.

3. ASSIGNOR WARRANTIES. Assignor represents and warrants to Assignee that:

(a) Other than in connection with the sale of lots to end users located within Assessment Area One and in the ordinary course of business, Assignor has made no assignment of the Development and Contract Rights to any person other than Assignee.

(b) To the actual knowledge of Assignor and except as permitted or stated herein, Assignor has not done any act or omitted to do any act which will prevent Assignee from, or limit Assignee in, acting under any of the provisions hereof.

(c) To the actual knowledge of Assignor, there is no material default under the terms of the existing Contract Documents and all such Contract Documents remain in full force and effect.

(d) Assignor is not prohibited under agreement with any other person or under any judgment or decree from the execution, delivery and performance of this Assignment.

(e) No action has been brought or threatened which would in any way interfere with the right of Assignor to execute this Assignment and perform all of Assignor's obligations herein contained.

(f) Any transfer, conveyance or sale of Assessment Area One, shall subject any and all affiliated entities or successors-in-interest of the Landowner to this Assignment (including successors-in-interest that are affiliates of Landowner), except to the extent constituting a Prior Transfer.

4. ASSIGNOR COVENANTS. Assignor covenants with Assignee that during the Term:

(a) Assignor will use commercially reasonable efforts to: (i) fulfill, perform, and observe each and every material condition and covenant of Assignor relating to the Development and Contract Rights, including, but not limited to, any material changes in the Development and Contract Rights; and (ii) give notice to Assignee of any claim of material default relating to the Development and Contract Rights given to or by Assignor, together with a complete copy of any such claim.

(b) In the event of the institution of any involuntary bankruptcy, reorganization or insolvency proceedings against the Assignor or the appointment of a receiver or a similar official with respect to all or a substantial part of the properties of the

Assignor, Assignor shall endeavor in good faith to have such proceedings dismissed or such appointment vacated within a period of one hundred twenty (120) days.

5. ASSIGNEE OBLIGATIONS. Nothing herein shall be construed as an obligation on the part of the Assignee to accept any liability for all or any portion of the Development and Contract Rights unless it chooses to do so in its sole discretion. Nor shall any provision hereunder be construed to place any liability or obligation on Assignee for compliance with the terms and provisions of all or any portion of the Development and Contract Rights.

6. EVENT(S) OF DEFAULT. Any material breach of the Assignor's warranties contained in Section 3 hereof or breach of covenants contained in Section 4 hereof, shall, after the giving of notice and after failure to cure within a reasonable cure period in light of the default (which cure period shall not be less than sixty (60) days (and shall not be construed to extend any other cure periods provided hereunder) unless Assignee, in its sole discretion, agrees to a longer cure period) constitute an Event of Default ("**Event of Default**"). Additionally, the failure to timely pay the Assessment Area One Assessments levied and imposed upon Assessment Area One owned by Assignor shall constitute an Event of Default.

7. REMEDIES UPON EVENT OF DEFAULT. Upon an Event of Default, Assignee or Assignee's designee may, as Assignee's sole and exclusive remedies under this Assignment (and separate and apart from any Remedial Rights or other rights provided by law), take any or all of the following actions, at Assignee's option:

(a) Perform any and all obligations of Assignor relating to the Development and Contract Rights and exercise any and all rights of Assignor therein as fully as Assignor could;

(b) Initiate, appear in, or defend any action arising out of or affecting the Development and Contract Rights;

(c) Sue for, or otherwise collect and receive, monies due under the Contract Documents, including those past due and unpaid, and apply the same against all costs and expenses of collection and then against all costs and expenses of operation of Assessment Area One or the performance of Assignor's obligations under the Contract Documents. Neither entry upon and taking possession of Assessment Area One nor the collection of monies due under the Contract Documents shall in any way operate to cure or waive any default under any instrument given by Assignor to Assignee, or prohibit the taking of any other action by Assignee under any such instrument, or at law or in equity, to enforce payment of the obligations secured hereby or to realize on any other security; and/or

(d) Demand, effective upon the occurrence of an Event of Default, and after Assignor's receipt of a demand notice from Assignee following an Event of Default, that Assignor use commercially reasonable efforts: (i) at the sole cost and expense of Assignor, to enforce the performance and observance of each and every material covenant and condition of the Contract Documents to be performed or observed; and (ii) appear in and defend any action involving the Contract Documents or the obligations or liabilities of

Assignor or any guarantor thereunder. Also to be effective upon the occurrence of an Event of Default, and after Assignor's receipt of a demand notice from following an Event of Default, Assignor will neither modify the terms of the Contract Documents in any material respect (unless required so to do by the terms thereof or to comply with documents executed in connection with the issuance of the Assessment Area One Bonds) nor waive or release any third party from the performance of any obligation to be performed or liability assumed under the terms of the Contract Documents or from liability on account of any warranty given by such third party, without the prior consent of Assignee, which consent shall not be unreasonably withheld, conditioned or delayed. Notwithstanding the foregoing, Assignor will not at any time knowingly take any action (or omit to take any action) with respect to the Development and Contract Rights that materially and adversely affect the rights of the District or the District's bondholders.

8. AUTHORIZATION OF PERFORMANCE. Upon the occurrence and during the continuation of an Event of Default, Assignor does hereby authorize and shall direct any party to any agreement relating to the Development and Contract Rights to tender performance thereunder to Assignee upon written notice and request from Assignee. Any such performance in favor of Assignee shall constitute a full release and discharge to the extent of such performance as fully as though made directly to Assignor.

9. SECURITY AGREEMENT. Subject to the terms of this Assignment, this Assignment shall be a security agreement between Assignor, as the debtor, and Assignee, as the secured party, covering the Development and Contract Rights and Contract Documents that constitute personal property governed by the Florida Uniform Commercial Code ("**Code**"), and Assignor grants to Assignee a security interest in such Development and Contract Rights and Contract Documents. Notwithstanding the foregoing, Assignee shall not be entitled to exercise any right as a secured party, including, without limitation, the filing of any and all financing statements, until the occurrence of an Event of Default hereunder, subject to any applicable notice and cure period.

10. SUCCESSORS; THIRD-PARTY BENEFICIARIES. This Assignment is solely for the benefit of the District and the Landowner and no right or cause of action shall accrue upon or by reason, to or for the benefit of any third party not a formal party to this Assignment. Nothing in this Assignment expressed or implied is intended or shall be construed to confer upon any person or entity other than the District and the Landowner any right, remedy, or claim under or by reason of this Assignment or any of the provisions or conditions of this Assignment; and all of the provisions, representations, covenants, and conditions contained in this Assignment shall inure to the sole benefit of and shall be binding upon the District and the Landowner and their respective representatives, successors, and assigns, subject to the provisions hereof regarding the automatic release of portions of Assessment Area One herefrom upon a Prior Transfer.

Notwithstanding the foregoing, the Trustee, acting at the direction of the Majority Holders of the Assessment Area One Bonds, shall have the right to directly enforce the provisions of this Assignment. The Trustee shall not be deemed to have assumed any obligations under this Assignment. This Assignment may not be assigned or materially amended without the consent of the Trustee, acting at the direction of the Majority Holders of the Assessment Area One Bonds, which consent shall not be unreasonably withheld.

11. ENFORCEMENT. In the event that either party is required to enforce this Assignment by court proceedings or otherwise, then the parties agree that the prevailing party shall be entitled to recover from the other all fees and costs incurred, including reasonable attorneys' fees and costs for trial, alternative dispute resolution, or appellate proceedings.

12. AMENDMENTS. Amendments to and waivers of the provisions contained in this Assignment may be made only by an instrument in writing which is executed by both the District and the Landowner.

13. AUTHORIZATION OF EXECUTION. The execution of this Assignment has been duly authorized by the appropriate body or official of the District and the Landowner; both the District and the Landowner have complied with all the requirements of law with respect to the execution of this Assignment; and both the District and the Landowner have full power and authority to comply with the terms and provisions of this instrument.

14. NOTICES. All notices, requests, consents and other communications under this Assignment (the "Notices") shall be in writing and shall be delivered, mailed by First Class Mail, postage prepaid, or overnight courier delivery service, to the parties, as follows:

A. If to the District: Hickory Tree CDD
c/o Governmental Management Services –
Central Florida, LLC
219 East Livingston Street
Orlando, Florida 32801
Attn: District Manager

With a copy to: Kilinski | Van Wyk PLLC
517 East College Avenue
Tallahassee, Florida 32301
Attn: District Counsel

B. If to the Landowner: Clayton Properties Group, Inc.
3020 South Florida Avenue, Suite 101
Lakeland, Florida 33803
Attn: D. Joel Adams

Except as otherwise provided in this Assignment, any Notice shall be deemed received only upon actual delivery at the address set forth above. Notices delivered after 5:00 p.m. (at the place of delivery) or on a non-business day, shall be deemed received on the next business day. If any time for giving Notice contained in this Assignment would otherwise expire on a non-business day, the Notice period shall be extended to the next succeeding business day. Saturdays, Sundays, and legal holidays recognized by the United States government shall not be regarded as business days. Counsel for the District and counsel for the Landowner may deliver Notice on behalf of the District and the Landowner. Any party or other person to whom Notices are to be sent or copied may notify the other parties and addressees of any change in name or address to which Notices

shall be sent by providing the same on five (5) days' written notice to the parties and addressees set forth herein.

15. ARM'S LENGTH TRANSACTION. This Assignment has been negotiated fully between the District and the Landowner as an arm's length transaction. Both parties participated fully in the preparation of this Assignment and received the advice of counsel. In the case of a dispute concerning the interpretation of any provision of this Assignment, both parties are deemed to have drafted, chosen, and selected the language, and the doubtful language will not be interpreted or construed against either the District or the Landowner.

16. APPLICABLE LAW AND VENUE. This Assignment and the provisions contained herein shall be construed, interpreted and controlled according to the laws of the State of Florida. Each party consents that the venue for any litigation arising out of or related to this Assignment shall be in Osceola County, Florida.

17. PUBLIC RECORDS. The Landowner understands and agrees that all documents of any kind provided to the District in connection with this Assignment may be public records and treated as such in accordance with Florida law.

18. SEVERABILITY. The invalidity or unenforceability of any one or more provisions of this Assignment shall not affect the validity or enforceability of the remaining portions of this Assignment, or any part of this Assignment not held to be invalid or unenforceable.

19. LIMITATIONS ON GOVERNMENTAL LIABILITY. Nothing in this Assignment shall be deemed as a waiver of immunity or limits of liability of the District beyond any statutory limited waiver of immunity or limits of liability which may have been adopted by the Florida Legislature in Section 768.28, *Florida Statutes*, or other statute, and nothing in this Assignment shall inure to the benefit of any third party for the purpose of allowing any claim which would otherwise be barred by sovereign immunity or by other operation of law.

20. HEADINGS FOR CONVENIENCE ONLY. The descriptive headings in this Assignment are for convenience only and shall not control nor affect the meaning or construction of any of the provisions of this Assignment.

21. COUNTERPARTS. This Assignment may be executed in any number of counterparts, each of which when executed and delivered shall be an original; however, all such counterparts together shall constitute, but one and the same instrument. Signature and acknowledgment pages, if any, may be detached from the counterparts and attached to a single copy of this document to physically form one document.

22. TERMINATION. This Assignment shall continue in effect until it is rescinded in writing by the mutual assent of the parties. This Assignment shall also be terminated upon full payment of the Assessment Area One Assessments securing the Assessment Area One Bonds, as evidenced by a Termination of Assignment recorded by the District.

23. EFFECTIVE DATE. This Assignment shall be effective after execution by both the District and the Landowner.

[REMAINDER OF PAGE LEFT INTENTIONALLY BLANK, SIGNATURES FOLLOW]

IN WITNESS WHEREOF, the Landowner and the District have caused this Assignment to be executed and delivered on the day and year first written above.

WITNESSES:

CLAYTON PROPERTIES GROUP, INC.,
a Tennessee corporation

Witness Signature
Printed name: _____

By: D. Joel Adams
Its: Vice President

Witness Signature
Printed name: _____

STATE OF FLORIDA)
COUNTY OF _____)

The foregoing instrument was acknowledged before me by means of physical presence or online notarization this ___ day of _____, 2023, by D. Joel Adams, as Vice President of **Clayton Properties Group, Inc.**, for and on behalf of said entity. He is personally known to me or produced _____ as identification.

NOTARY STAMP:

Signature of Notary Public

Printed Name of Notary Public

WITNESSES:

**HICKORY TREE COMMUNITY
DEVELOPMENT DISTRICT**

Witness Signature
Printed name: _____

Chairperson, Board of Supervisors

Witness Signature
Printed name: _____

STATE OF FLORIDA)
COUNTY OF _____)

The foregoing instrument was acknowledged before me by means of physical presence or online notarization this ____ day of _____, 2023, by Milton Andrade, as Chairperson of the Board of Supervisors of the Hickory Tree Community Development District, for and on behalf of the District. He is personally known to me or produced _____ as identification.

NOTARY STAMP:

Signature of Notary Public

Printed Name of Notary Public

EXHIBIT A
LEGAL DESCRIPTION OF ASSESSMENT AREA ONE

SECTION C

AGREEMENT BETWEEN THE HICKORY TREE COMMUNITY DEVELOPMENT DISTRICT AND CLAYTON PROPERTIES GROUP, INC. REGARDING THE COMPLETION OF DISTRICT IMPROVEMENTS

THIS COMPLETION AGREEMENT (the “**Agreement**”) is made and entered into this ____ day of _____, 2023, by and between:

HICKORY TREE COMMUNITY DEVELOPMENT DISTRICT, a local unit of special-purpose government established pursuant to Chapter 190, *Florida Statutes*, being situated in Osceola County, Florida, whose address is c/o Governmental Management Services – Central Florida, LLC, 219 East Livingston Street, Orlando, Florida 32801 (the “**District**”); and

CLAYTON PROPERTIES GROUP, INC., a Tennessee corporation, the developer and owner of lands within the District, with offices located at 3020 South Florida Avenue, Suite 101, Lakeland, Florida, 33803 (together with its successors and assigns, the “**Landowner**”).

RECITALS

WHEREAS, the District was established by ordinance adopted by the Board of County Commissioners in and for Osceola County, Florida, pursuant to the Uniform Community Development District Act of 1980, Chapter 190, *Florida Statutes*, as amended (the “**Act**”), for the purpose of planning, financing, constructing, acquiring, operating and/or maintaining certain public infrastructure improvements within or without the boundary of the District; and

WHEREAS, the Act authorizes the District to issue bonds for the purposes, among others, of planning, financing, constructing, operating and/or maintaining certain public infrastructure, including but not limited to roadways, stormwater management, utilities (water & sewer), offsite improvements, landscaping/lighting, and other infrastructure within or without the boundaries of the District; and

WHEREAS, Landowner is the owner and the developer of certain lands in Osceola County, Florida, located within the boundaries of the District, which property description is attached hereto as **Exhibit A** and is incorporated herein by this reference (“**Assessment Area One**”); and

WHEREAS, the District has adopted an improvement plan for the planning, design, acquisition, construction, and installation of certain infrastructure improvements, facilities and services within and without the boundaries of the District, which plan is detailed in its *Hickory Tree Community Development District Engineer’s Report*, dated June 28, 2022 (“**Master Engineer’s Report**” and the improvements detailed therein, the “**Capital Improvement Plan**”), as supplemented by that certain *Hickory Tree Community Development District Supplemental Engineer’s Report (Assessment Area One)*, dated September 6, 2023 (“**Supplemental Engineer’s Report**” and the project detailed therein, the “**Assessment Area One Project**” and together with the Master Engineer’s Report, the “**Engineer’s Report**”); and

WHEREAS, the estimated cost of the Assessment Area One Project is \$ _____ ;
and

WHEREAS, a Final Judgment was issued on December 20, 2022, validating the authority of the District to issue up to \$53,090,000 in aggregate principal amount of Hickory Tree Community Development District Special Assessment Bonds to finance certain improvements and facilities within and without the District boundaries; and

WHEREAS, the District is presently in the process of issuing \$ _____ of Hickory Tree Community Development District Special Assessment Bonds, Series 2023 (“**Assessment Area One Bonds**”) to finance a portion of the design, construction or acquisition of the Capital Improvement Plan referred to herein as the Assessment Area One Project; and

WHEREAS, the Assessment Area One Project will benefit all lands within the District, as described in the District’s *Master Assessment Methodology for Hickory Tree Community Development District*, dated June 28, 2022 (“**Master Assessment Report**”), as supplemented by that certain *First Supplemental Assessment Methodology (Assessment Area One Project)*, dated September 6, 2023 (the “**Supplemental Assessment Report**” together with the Master Assessment Report, the “**Assessment Report**”); and

WHEREAS, in order to ensure that the Assessment Area One Project is completed and funding is available in a timely manner to provide for completion, the Landowner will make provision for any additional funds that may be needed in the future for the completion of the Assessment Area One Project over and above the Assessment Area One Bonds, including, but not limited to, all reasonable and customary administrative, legal, warranty, engineering, permitting or other related soft costs.

NOW, THEREFORE, based upon good and valuable consideration and the mutual covenants of the parties, the receipt of which and sufficiency of which are hereby acknowledged, the District and the Landowner agree as follows:

1. INCORPORATION OF RECITALS. The recitals stated above are true and correct and are incorporated herein by this reference as a material part of this Agreement.

2. COMPLETION OF ASSESSMENT AREA ONE PROJECT. The Landowner and District agree and acknowledge that the District’s proposed Assessment Area One Bonds will provide only a portion of the funds necessary to complete the Assessment Area One Project. Therefore, as more particularly set forth in paragraphs 2(a) and 2(b) below, the Landowner hereby agrees to complete, cause to be completed, provide funds or cause funds to be provided to the District in an amount sufficient to allow the District to complete or cause to be completed, those portions of the Assessment Area One Project which remain unfunded including, but not limited to, all reasonable and customary administrative, legal, warranty, engineering, permitting or other related soft costs (“**Remaining Project**”) whether pursuant to existing contracts, including change orders thereto, or future contracts. While it is anticipated the District will issue a second series of bonds for purposes of financing a portion of the Remaining Project, nothing herein shall cause or be construed to require the District to issue additional bonds or indebtedness to provide funds for any

portion of the Remaining Project nor shall anything in this Agreement be construed as prohibiting the District from doing so in the future. The District and Landowner hereby acknowledge and agree that the District's execution of this Agreement constitutes the manner and means by which the District has elected to provide any and all portions of the Remaining Project not funded by District bonds or other indebtedness.

(a) When all or any portion of the Remaining Project is the subject of a District contract, the Landowner shall provide funds or cause funds to be provided directly to the District in an amount sufficient to complete the Remaining Project under such contract pursuant thereto, including change orders thereto, upon written notice from the District.

(b) When any portion of the Remaining Project is not the subject of a District contract, the Landowner may choose to: (i) complete, cause to be completed, provide funds or cause funds to be provided to the District in an amount sufficient to allow the District to complete or cause to be completed the Remaining Project; or (ii) have the District enter into a contract and proceed under Section 2(a) above, subject, in each case to a formal determination by the District's Board of Supervisors that the option selected by the Landowner will not adversely impact the District, and is in the District's best interests.

(c) Future Bonds – The parties agree that any funds provided by Landowner to fund the Remaining Project may be later payable from, and the District's acquisition of the Remaining Project may be payable from, the proceeds of a future issuance of bonds by the District (i.e., other than the Assessment Area One Bonds). Within forty-five (45) days of receipt of sufficient funds by the District for the District's improvements and facilities and from the issuance of such future bonds, the District shall reimburse Landowner in full, exclusive of interest, for the funds and/or improvements provided pursuant to this Agreement; provided, however, that no such obligation shall exist where the Landowner is in default on the payment of any debt service assessments due on any property owned by the Landowner, and, further, in the event the District's bond counsel determines that any such monies advanced or expenses incurred are not properly reimbursable for any reason, including, but not limited to federal tax restrictions imposed on tax-exempt financing, the District shall not be obligated to reimburse such monies advanced or expenses incurred. Nothing herein shall cause or be construed to require the District to issue additional bonds or indebtedness – other than the Assessment Area One Bonds – to provide funds for any portion of the Remaining Project. The Landowner shall be required to meet its obligations hereunder and complete the Assessment Area One Project regardless of whether the District issues any future bonds (other than the Assessment Area One Bonds) or otherwise pays the Landowner for any of the Remaining Project. Interest shall not accrue on any amounts owed hereunder. If within five (5) years of the date of this Agreement, the District does not or cannot issue such future bonds, and thus does not reimburse the Landowner for the funds or improvements advanced hereunder, then the parties agree that the District shall have no reimbursement obligation whatsoever. Notwithstanding the foregoing, the Landowner acknowledges that at this time the District does not intend to issue additional bonds to finance the Remaining Project.

3. OTHER CONDITIONS AND ACKNOWLEDGMENTS.

(a) The District and the Landowner agree and acknowledge that the exact location, size, configuration and composition of the Assessment Area One Project may change from that described in the Supplemental Engineer's Report, depending upon final design of the development, permitting or other regulatory requirements over time, or other factors. Material changes to the Assessment Area One Project shall be made by a written amendment to the Supplemental Engineer's Report, which shall include an estimate of the cost of the changes. Material changes to the Assessment Area One Project shall require the prior written consent of the Trustee acting at the direction of the bondholders holding a majority of the aggregate principal amount of the bonds then outstanding; however such consent is not necessary when the scope, configuration, size and/or composition of the improvements making up the Assessment Area One Project are materially changed in response to a requirement imposed by a regulatory agency.

(b) The District and Landowner agree and acknowledge that any and all portions of the Remaining Project which are required for construction and/ or completion of the Assessment Area One Project shall be conveyed to the District, to the extent not delivered by the District, or such other appropriate unit of local government or public utility as is designated in the Engineer's Report or required by governmental regulation or development approval. All conveyances to another governmental entity shall be in accordance with and in the same manner as provided in any agreement between the District and the appropriate unit of local government.

(c) Notwithstanding anything to the contrary contained in this Agreement, the payment or performance by Landowner of its obligations hereunder is expressly subject to, dependent and conditioned upon: (a) the issuance of the Assessment Area One Bonds and use of the proceeds thereof to fund a portion of the Assessment Area One Project, and (b) the scope, configuration, size and/or composition of the Assessment Area One Project not materially changing without the consent of the Landowner; however, such consent is not necessary and the Landowner must meet its completion obligations when the scope, configuration, size and/or composition of the improvements that make up the Assessment Area One Project are materially changed in response to a requirement imposed by a regulatory agency. In the event of a material change to the scope, configuration, size and/or composition of the Assessment Area One Project in response to a requirement imposed by a regulatory agency, the Landowner shall not consent to such material change without the prior written consent of the District.

4. DEFAULT AND PROTECTION AGAINST THIRD PARTY INTERFERENCE. A default by either party under this Agreement shall entitle the other to all remedies available at law or in equity, which may include, but not be limited to, the right of actual damages (excluding punitive, special or consequential damages) and/or specific performance.

5. ENFORCEMENT OF AGREEMENT. In the event that either of the parties is required to enforce this Agreement by court proceedings or otherwise, then the parties agree that the prevailing party shall be entitled to recover from the other all fees and costs incurred, including

reasonable attorneys' fees and costs for trial, alternative dispute resolution, or appellate proceedings.

6. AMENDMENTS. Amendments to and waivers of the provisions contained in this Agreement may be made only by an instrument in writing which is executed by both the District and the Landowner.

7. AUTHORIZATION. The execution of this Agreement has been duly authorized by the appropriate body or official of the District and the Landowner, both the District and the Landowner have complied with all the requirements of law, and both the District and the Landowner have full power and authority to comply with the terms and provisions of this instrument.

7. NOTICES. All notices, requests, consents and other communications under this Agreement (the “**Notices**”) shall be in writing and shall be delivered, mailed by First Class Mail, postage prepaid, or overnight delivery service, to the parties, as follows:

A. If to the District: Hickory Tree CDD
c/o Governmental Management Services –
Central Florida, LLC
219 East Livingston Street
Orlando, Florida 32801
Attn: District Manager

With a copy to: Kilinski | Van Wyk PLLC
517 East College Avenue
Tallahassee, Florida 32301
Attn: District Counsel

B. If to the Landowner: Clayton Properties Group, Inc.
3020 South Florida Avenue, Suite 101
Lakeland, Florida 33803
Attn: D. Joel Adams

Except as otherwise provided in this Agreement, any Notice shall be deemed received only upon actual delivery at the address set forth above. Notices delivered after 5:00 p.m. (at the place of delivery) or on a non-business day, shall be deemed received on the next business day. If any time for giving Notice contained in this Agreement would otherwise expire on a non-business day, the Notice period shall be extended to the next succeeding business day. Saturdays, Sundays, and legal holidays recognized by the United States government shall not be regarded as business days. Counsel for the District and counsel for the Landowner may deliver Notice on behalf of the District and the Landowner. Any party or other person to whom Notices are to be sent or copied may notify the other parties and addressees of any change in name or address to which Notices shall be sent by providing the same on five (5) days' written notice to the parties and addressees set forth herein.

8. ARM'S LENGTH TRANSACTION. This Agreement has been negotiated fully between the District and the Landowner as an arm's length transaction. Both parties participated fully in the preparation of this Agreement and received the advice of counsel. In the case of a dispute concerning the interpretation of any provision of this Agreement, both parties are deemed to have drafted, chosen, and selected the language, and the doubtful language will not be interpreted or construed against either the District or the Landowner.

10. THIRD-PARTY BENEFICIARIES. This Agreement is solely for the benefit of the District and the Landowner and no right or cause of action shall accrue upon or by reason, to or for the benefit of any third party not a formal party to this Agreement. Nothing in this Agreement expressed or implied is intended or shall be construed to confer upon any person or corporation other than the District and the Landowner any right, remedy, or claim under or by reason of this Agreement or any of the provisions or conditions of this Agreement; and all of the provisions, representations, covenants, and conditions contained in this Agreement shall inure to the sole benefit of and shall be binding upon the District and the Landowner and their respective representatives, successors, and assigns.

Notwithstanding anything in this Agreement to the contrary, the Trustee for the Assessment Area One Bonds shall be a direct third-party beneficiary of the terms and conditions of this Agreement and, acting at the direction of and on behalf of the bondholders owning a majority of the aggregate principal amount of the Assessment Area One Bonds outstanding, shall be entitled to cause the District to enforce the Landowner's obligations hereunder. The Trustee shall not be deemed to have assumed any obligations under this Agreement.

11. ASSIGNMENT. Neither the District nor the Landowner may assign this Agreement or any monies to become due hereunder without the prior written approval of the other; provided that such consent shall not be unreasonably withheld by the District in the event of a sale of the majority of Assessment Area One then owned by the Landowner pursuant to which the unaffiliated purchaser agrees to assume any remaining obligations of the Landowner under this Agreement.

12. APPLICABLE LAW AND VENUE. This Agreement and the provisions contained herein shall be construed, interpreted and controlled according to the laws of the State of Florida. Each party consents that the venue for any litigation arising out of or related to this Agreement shall be in Osceola County, Florida.

13. EFFECTIVE DATE. This Agreement shall be effective upon the later of the execution by the District and the Landowner.

14. PUBLIC RECORDS. The Landowner understands and agrees that all documents of any kind provided to the District in connection with this Agreement may be public records and treated as such in accordance with Florida law.

15. SEVERABILITY. The invalidity or unenforceability of any one or more provisions of this Agreement shall not affect the validity or enforceability of the remaining portions of this Agreement, or any part of this Agreement not held to be invalid or unenforceable.

16. LIMITATIONS ON GOVERNMENTAL LIABILITY. Nothing in this Agreement shall be deemed as a waiver of immunity or limits of liability of the District beyond any statutory limited waiver of immunity or limits of liability which may have been adopted by the Florida Legislature in Section 768.28, *Florida Statutes*, or other statute, and nothing in this Agreement shall inure to the benefit of any third party for the purpose of allowing any claim which would otherwise be barred under the Doctrine of Sovereign Immunity or by operation of law.

17. HEADINGS FOR CONVENIENCE ONLY. The descriptive headings in this Agreement are for convenience only and shall not control nor affect the meaning or construction of any of the provisions of this Agreement.

18. COUNTERPARTS. This Agreement may be executed in any number of counterparts, each of which when executed and delivered shall be an original; however, all such counterparts together shall constitute, but one and the same instrument. Signature and acknowledgment pages, if any, may be detached from the counterparts and attached to a single copy of this document to physically form one document.

19. TERMINATION. This Agreement shall continue in effect until completion of the Remaining Project, as evidenced by a Notice of Completion from the District Engineer.

[Signatures on following page]

IN WITNESS WHEREOF, the parties execute this Completion Agreement the day and year first written above.

Attest:

**HICKORY TREE COMMUNITY
DEVELOPMENT DISTRICT**

Secretary/Assistant Secretary

By: Milton Andrade
Its: Chairperson, Board of Supervisors

IN WITNESS WHEREOF, the parties execute this Completion Agreement the day and year first written above.

CLAYTON PROPERTIES GROUP, INC., a
Tennessee corporation

Witness

By: D. Joel Adams
Its: Vice President

Exhibit A: Assessment Area One

Exhibit B: Engineer's Reports

EXHIBIT A
ASSESSMENT AREA ONE

EXHIBIT B
ENGINEER'S REPORTS

[attached beginning at following page]

SECTION D

**AGREEMENT BY AND BETWEEN THE HICKORY TREE COMMUNITY
DEVELOPMENT DISTRICT AND CLAYTON PROPERTIES GROUP, INC.
REGARDING THE ACQUISITION OF WORK PRODUCT,
IMPROVEMENTS, AND REAL PROPERTY**

THIS AGREEMENT (“**Agreement**”) is made and entered into this ___ day of September, 2023, by and between:

HICKORY TREE COMMUNITY DEVELOPMENT DISTRICT, a local unit of special-purpose government established pursuant to Chapter 190, *Florida Statutes*, being situated in Osceola County, Florida, whose address is c/o Governmental Management Services – Central Florida, LLC, 219 East Livingston Street, Orlando, Florida 32801 (the “**District**”); and

CLAYTON PROPERTIES GROUP, INC., a Tennessee corporation, the developer and owner of certain lands within the District, with a mailing address of 5000 Clayton Road, Maryville, Tennessee 37804, and its successors and assigns (the “**Developer**” and, together with the District, the “**Parties**”).

RECITALS

WHEREAS, the District was established for the purposes of planning, financing, constructing, acquiring, operating and/or maintaining certain public infrastructure, as authorized by Chapter 190, *Florida Statutes*; and

WHEREAS, the District has adopted an improvement plan for the planning, design, acquisition, construction, and installation of certain infrastructure improvements, facilities and services (the “**Improvements**”) within and without the boundaries of the District, and the anticipated cost thereof, as described in that certain *Hickory Tree Community Development District Engineer’s Report*, dated June 28, 2022 (the “**Master Engineer’s Report**”), as supplemented by that certain *Hickory Tree Community Development District Supplemental Engineer’s Report (Assessment Area One)*, dated September 6, 2023 (“**Supplemental Engineer’s Report**” and the project detailed therein, the “**Assessment Area One Project**” and together with the Master Engineer’s Report, the “**Engineer’s Report**”), attached hereto as **Exhibit A** and incorporated herein by reference; and

WHEREAS, the Developer is the owner and the developer of certain lands located within the boundaries of the District identified in the Engineer’s Report and further described in **Exhibit B (“Assessment Area One”)** within which all or a portion of the District Improvements will be located; and

WHEREAS, the District intends to finance all or a portion of the Improvements through the anticipated issuance of its \$_____ Hickory Tree Community Development District Special Assessment Bonds, Series 2023 (Assessment Area One) (the “**Assessment Area One Bonds**”) and may further issue bonds in the future; and

WHEREAS, because the Assessment Area One Bonds have not yet been issued, the District has not had sufficient monies on hand to allow the District to fund the cost of preparation of the necessary surveys, reports, drawings, plans, permits, specifications, and related documents which would allow the timely commencement and completion of construction of the Assessment Area One Project (the “**Work Product**”); and

WHEREAS, the District acknowledges the Developer’s need to have the Improvements, including the Assessment Area One Project, constructed in an expeditious and timely manner in order to develop the District lands including the lands encompassing Assessment Area One; and

WHEREAS, the District agrees that it will not have sufficient monies to proceed with either the preparation of the Work Product or the commencement of construction of the Improvements described in **Exhibit A** until such time as the District has closed on the sale of the Assessment Area One Bonds; and

WHEREAS, to avoid a delay in the commencement of the construction of the Improvements, the Developer has advanced, funded, commenced, and completed and/or will complete certain work to enable the District to expeditiously provide the Improvements; and

WHEREAS, the District desires to commence the acquisition of certain Work Product and the Improvements, and accept assignment of certain agreements regarding the same; and

WHEREAS, in conjunction with the acquisition of the Work Product and/or Improvements, the Developer desires to convey to the District interests in real property sufficient to allow the District to own, operate, maintain, construct, or install the Improvements, if any such conveyances are appropriate, and such conveyances shall be in fee simple, perpetual easement, or other interest as may be in the best interests of the District (the “**Real Property**”); and

WHEREAS, the Developer and the District desire to enter into this Agreement to set forth the process by which the District may acquire the Work Product, Improvements, and/or Real Property.

NOW, THEREFORE, based upon good and valuable consideration and the mutual covenants of the Parties, the receipt and sufficiency of which are hereby acknowledged, the District and the Developer agree as follows:

SECTION 1. INCORPORATION OF RECITALS. The recitals stated above are true and correct and by this reference are incorporated herein and form a material part of this Agreement.

SECTION 2. WORK PRODUCT. The District agrees to pay the lesser of actual cost incurred by the Developer or fair market value, for preparation of the Work Product in accordance with the provisions of this Agreement. The Developer shall provide copies of any and all invoices, bills, receipts, or other evidence of costs incurred by the Developer for the Work Product. The Parties agree to cooperate and use good faith and best efforts to undertake and complete the acquisition process contemplated by this Agreement on such date as the Parties may jointly agree upon (the “**Acquisition Date**”). The Parties agree that separate or multiple Acquisition Dates may

be established for any portion of the acquisitions contemplated by this Agreement. The District Engineer shall review all evidence of cost and shall certify to the District's Board of Supervisors (the "**Board**") the total actual amount of cost, which, in the District Engineer's sole opinion, is reasonable for the Work Product. The District Engineer's opinion as to cost shall be set forth in an Engineer's Certificate which shall accompany the requisition for the funds from the trustee for the Assessment Area One Bonds ("**Trustee**"). In the event that the Developer disputes the District Engineer's opinion as to cost, the District and the Developer agree to use good faith efforts to resolve such dispute. If the Parties are unable to resolve any such dispute, the Parties agree to jointly select a third-party engineer whose decision as to any such dispute shall be binding upon the Parties. Such decision by a third-party engineer shall be set forth in an Engineer's Affidavit which shall accompany the requisition for the funds from the Trustee. The Parties acknowledge that the Work Product is being acquired for use by the District in connection with the construction of the Improvements.

A. The Developer agrees to convey to the District, and solely to the extent permitted by the terms of the Work Product, the Work Product upon payment of the sums determined to be acceptable by the District Engineer and approved by the District's Board pursuant to and as set forth in this Agreement.

B. The Developer agrees to release to the District all right, title, and interest which the Developer may have in and to the above described Work Product, as well as all common law, statutory, and other reserved rights, including all copyrights in the Work Product and extensions and renewals thereof under United States law and throughout the world, and all publication rights and all subsidiary rights and other rights in and to the Work Product in all forms, mediums, and media, now known or hereinafter devised; provided, however, that the District agrees and acknowledges that the Developer shall retain the right, title and interest to use the Work Product, and the District shall grant the Developer a license to use the Work Product to the extent reasonably required by the Developer in connection with the ownership, construction, development, and management of the Assessment Area One Project or other lands owned by Developer to which such Work Product pertains. To the extent determined necessary by the District, the Developer shall use commercially reasonable efforts to obtain all releases from any professional providing services in connection with the Work Product to enable the District to use and rely upon the Work Product. Such releases may include, but are not limited to, any architectural, engineering, or other professional services.

C. Except as otherwise separately agreed by the Parties with respect to any particular acquisition of Work Product, and without intending to modify any of the other terms of this Agreement, any conveyance of Work Product shall be on an "AS-IS" basis, and without any representation or warranty from the Developer to the District in respect thereto.

D. The Developer agrees to make reasonable good faith efforts, but without imposing any requirement on Developer to pay for additional warranty rights on behalf of the District, to provide or cause to be provided to the District, either by assignment or directly from such third parties as may be necessary and desirable to the mutual satisfaction

of the Parties hereto, a warranty that the Work Product is fit for the purposes to which it will be put by the District, as contemplated by the Engineer's Report.

E. The District agrees to allow the Developer access to and use of the Work Product without the payment of any fee by the Developer. However, to the extent the Developer's access to and use of the Work Product causes the District to incur any cost or expense, such as copying costs, the Developer agrees to pay such cost or expense.

SECTION 3. IMPROVEMENTS. The Developer has expended certain funds on behalf of the District relating to the Improvements. The District agrees to acquire or otherwise reimburse the Developer for those portions of the Improvements which have been commenced or completed prior to the issuance of the Assessment Area One Bonds. When a portion of the Improvements is ready for conveyance by the Developer to the District, the Developer shall notify the District in writing, describing the nature of the improvement, its general location, and its estimated cost. Developer agrees to provide, at or prior to the Acquisition Date, the following: (i) documentation of actual costs paid; (ii) instruments of conveyance such as special warranty bills of sale or such other instruments as may be reasonably requested by the District; and (iii) any other releases, indemnifications, or documentation as may be reasonably requested by the District. Any real property interests necessary for the functioning of the Improvements to be acquired under this paragraph shall be reviewed and conveyed in accordance with the provisions of Section 5 herein. The District Engineer in consultation with District Counsel shall determine in writing whether the infrastructure to be conveyed is a part of the Improvements contemplated by the Engineer's Report, and if so, shall provide Developer with a list of items necessary to complete the acquisition. Each such acquisition shall also be subject to the engineering review and certification process described in Section 2 above. The District Manager shall determine, in writing, whether the District has, based on the Developer's estimate of cost, sufficient unencumbered funds to acquire the improvement.

A. All documentation of any acquisition (e.g., bills of sale, receipts, maintenance bonds, as-builts, evidence of costs, deeds or easements, etc.) shall be to the reasonable satisfaction of the District. If any item acquired is to be conveyed to a third-party governmental entity, then the Developer agrees to cooperate and provide such certifications, warranties, representations or other items as may be required by that governmental entity, if any.

B. The District Engineer shall certify as to the actual cost of any improvement built or constructed by or at the direction of the Developer, and the District shall pay no more than the actual cost incurred, or the fair market value of the improvement, whichever is less, as determined by the District Engineer.

C. The Developer agrees to cooperate in the transfer of any permits to the District or another governmental entity with maintenance obligations for any Improvements conveyed pursuant to this Agreement.

D. Nothing herein shall require the District to accept any Work Product and/or Improvements unless the District Engineer, in his or her professional opinion, is able to

certify that, in addition to any other requirements of law: (i) the Work Product and/or Improvements are as set forth in the Engineer's Report; (ii) the price for such Work Product and/or Improvements is equal to or less than each of (a) the cost actually paid to develop and/or install the Work Product and/or Improvements by the Developer and (b) the reasonable fair market value of the Work Product and/or Improvements; (iii) as to Work Product, the Work Product is capable of being used for the purposes intended by the District, and, as to any Improvements, the Improvements were installed in accordance with their specifications, and are capable of performing the functions for which they were intended; and (iv) as to any Improvements, all known plans, permits and specifications necessary for the operation and maintenance of the Improvements are complete and on file with the District, and have been transferred, or are capable of being transferred, to the District for operations and maintenance responsibilities.

SECTION 4. ASSIGNMENT OF CONTRACTS. The District may accept the assignment of certain contracts. Such acceptance is predicated upon: (i) each contractor providing a bond in the form and manner required by Section 255.05, *Florida Statutes*, or the Developer providing adequate alternative security in compliance with Section 255.05, *Florida Statutes*, if required; and (ii) receipt by the District of a release from each general contractor acknowledging each assignment and the validity thereof, acknowledging the furnishing of the bond or other security required by Section 255.05, *Florida Statutes*, if any, and waiving any and all claims against the District arising as a result of or connected with such assignment. Until such time as the Assessment Area One Bonds are actually issued, the Developer agrees to provide such funds as are needed by the District to make all payments for any such assigned contracts when and as needed by the District.

SECTION 5. CONVEYANCE OF REAL PROPERTY.

A. Conveyance. In the event that real property interests are to be conveyed by the Developer and acquired by the District in connection with the acquisition of the Improvements, and as mutually agreed upon by the District and the Developer, then in such event, the Developer agrees that it will convey to the District at or prior to the Acquisition Date by a special warranty deed, or non-exclusive easement, as reasonably acceptable to the District together with a metes and bounds or other legal description, the Real Property upon which the Improvements are constructed or which are necessary for the operation and maintenance of, and access to the Improvements. The Parties agree that in no event shall the purchase price for the Real Property exceed the lesser of the actual cost to the Developer or the value of an appraisal obtained by the District for this purpose. The Parties agree that the purchase price shall not include amounts attributable to the value of improvements on the Real Property and other improvements serving the Real Property that have been, or will be, funded by the District. The District may determine in its reasonable discretion that fee title is not necessary and in such cases shall accept such other interest in the lands upon which the Improvements are constructed as the District deems reasonably acceptable. Such special warranty deed or other instrument shall be subject to a reservation by Developer of its right and privilege to use the area conveyed to construct any Improvements and any future improvements to such area for any related purposes (including, but not limited to, construction traffic relating to the construction of the development) not

inconsistent with the District's use, occupation or enjoyment thereof. The Developer shall pay the cost for recording fees and documentary stamps required, if any, for the conveyance of the lands upon which the Improvements are constructed. The Developer shall be responsible for all taxes and assessments levied on the lands upon which the Improvements are constructed until such time as the Developer conveys said lands to the District. At the time of conveyance, the District may require, at Developer's expense, an owner's title insurance policy in a form satisfactory to the District. In the event the title search reveals exceptions to title which render title unmarketable or which, in the District's reasonable discretion, would materially interfere with the District's use of such lands, the District shall not be required to accept such conveyance of Real Property and/or any related Improvements or Work Product.

B. *Boundary or Other Adjustments.* Developer and the District agree that reasonable future boundary adjustments may be made as deemed necessary and approved by both Parties in order to accurately describe lands conveyed to the District and lands which remain in Developer's ownership; provided, however, that such future boundary adjustments shall not affect the ability of the Developer to have the lots developed. The Parties agree that any land transfers made to accommodate such adjustments shall be accomplished by donation. However, the party requesting such adjustment shall pay any transaction costs resulting from the adjustment, including but not limited to taxes, title insurance, recording fees or other costs.

SECTION 6. TAXES, ASSESSMENTS, AND COSTS.

A. *Taxes and Assessments on Property Being Acquired.* The District is an exempt governmental unit acquiring property pursuant to this Agreement for use exclusively for public purposes. Accordingly, in accordance with Florida law, the Developer agrees to place in escrow with the Osceola County Tax Collector an amount equal to the current ad valorem taxes and non-ad valorem assessments prorated to the date of transfer of title, based upon the expected assessment and millage rates giving effect to the greatest discount available for early payment.

1. If and only to the extent the property acquired by the District is subject to ad valorem taxes or non-ad valorem assessments, the Developer agrees to reimburse the District for payment, or pay on its behalf, any and all ad valorem taxes and non-ad valorem assessments imposed during the calendar year in which each parcel of property is conveyed.

2. Nothing in this Agreement shall prevent the District from asserting any rights to challenge any taxes or assessments imposed, if any, on any property of the District.

B. *Notice.* The Parties agree to provide notice to the other within ten (10) calendar days of receipt of any notice of potential or actual taxes, assessments, or costs, as a result of any transaction pursuant to this Agreement or notice of any other taxes assessments or costs imposed on the property acquired by the District as described in

Subsection A above. The Developer covenants to make any payments due hereunder in a timely manner in accordance with Florida law. In the event that the Developer fails to make timely payment of any such taxes or costs, the Developer acknowledges the District's right to make such payment. If the District makes such payment, the Developer agrees to reimburse the District within thirty (30) calendar days of receiving notice of such payment, and to include in such reimbursement any fees, costs, penalties, or other expenses which accrued to the District as a result of making such a payment, including interest at the maximum rate allowed by law from the date of the payment made by the District.

C. Tax liability not created. Nothing herein is intended to create or shall create any new or additional tax liability on behalf of the Developer or the District. Furthermore, the Parties reserve all respective rights to challenge, pay under protest, contest or litigate the imposition of any tax, assessment, or cost in good faith they believe is unlawfully or inequitably imposed and agree to cooperate in good faith in the challenge of any such imposition.

SECTION 7. ACQUISITION IN ADVANCE OF RECEIPT OF PROCEEDS. The District and Developer hereby agree that an acquisition by the District may be completed prior to the District obtaining proceeds from the Assessment Area One Bonds ("**Prior Acquisitions**"). The District agrees to pursue the issuance of the Assessment Area One Bonds in good faith and, within thirty (30) days from the issuance of such Assessment Area One Bonds, to make payment for any Prior Acquisitions completed pursuant to the terms of this Agreement; provided, however, that in the event Bond Counsel determines that any such Prior Acquisitions are not properly compensable for any reason, including, but not limited to, federal tax restrictions imposed on tax-exempt financing, the District shall not be obligated to make payment for such Prior Acquisitions. Interest shall not accrue on the amounts owed for any Prior Acquisitions. In the event the District does not or cannot issue the Assessment Area One Bonds within five (5) years from the date of this Agreement, and, thus does not make payment to the Developer for the Prior Acquisitions, the Parties agree that the District shall have no reimbursement obligation whatsoever. The Developer acknowledges that the District intends to convey some or all of the Improvements to the State of Florida and Osceola County and consents to the District's conveyance of such improvements prior to payment for any Prior Acquisitions.

SECTION 8. DEFAULT. A default by either Party under this Agreement shall entitle the other to all remedies available at law or in equity, which may include, but not be limited to, the right of damages and/or specific performance, but excluding special, consequential or punitive damages.

SECTION 9. INDEMNIFICATION. For all actions or activities which occur prior to the date of the acquisition of the relevant Real Property, Improvement or Work Product hereunder, the Developer agrees to indemnify and hold harmless the District and its officers, staff, agents and employees from any and all liability, claims, actions, suits or demands by any person, corporation or other entity for injuries, death, property damage or claims of any nature arising out of, or in connection with, the use by the Developer, its officers, agents, employees, invitees or affiliates, of the Real Property, Improvement, or Work Product, including litigation or any appellate proceedings with respect thereto, irrespective of the date of the initiation or notice of the claim,

suit, etc.; provided, however, that the Developer shall not indemnify the District for a default by the District under this Agreement or the use of such Real Property, Improvement or Work Product by the District, its engineers, employees, contractors, or such persons' or entities' negligence.

SECTION 10. ENFORCEMENT OF AGREEMENT. In the event that any Party is required to enforce this Agreement by court proceedings or otherwise, then the Parties agree that the substantially prevailing party shall be entitled to recover from the other(s) all fees and costs incurred, including reasonable attorneys' fees, paralegal fees and expert witness fees, and costs for trial, alternative dispute resolution, or appellate proceedings.

SECTION 11. ENTIRE AGREEMENT. This instrument shall constitute the final and complete expression of the agreement between the District and the Developer relating to the subject matter of this Agreement.

SECTION 12. AMENDMENTS. This Agreement shall constitute the entire agreement between the Parties regarding the subject matter hereof and may be modified in writing only by the mutual agreement of all Parties, and with regards to material amendments, with the prior written consent of the Trustee for the Assessment Area One Bonds acting at the direction of the bondholders owning a majority of the aggregate principal amount of the Assessment Area One Bonds then outstanding.

SECTION 13. AUTHORIZATION. The execution of this Agreement has been duly authorized by the appropriate body or official of the District and the Developer. The District and the Developer have complied with all the requirements of law. The District and the Developer have full power and authority to comply with the terms and provisions of this Agreement.

SECTION 14. NOTICES. All notices, requests, consents and other communications under this Agreement ("Notices") shall be in writing and shall be delivered, mailed by First Class Mail, postage prepaid, or overnight delivery service, to the Parties, as follows:

(a) If to the District: Hickory Tree CDD
c/o Governmental Management Services –
Central Florida, LLC
219 East Livingston Street
Orlando, Florida 32801
Attn: District Manager

With a copy to: Kilinski | Van Wyk PLLC
517 East College Avenue
Tallahassee, Florida 32301
Attn: District Counsel

(b) If to the Developer: Clayton Properties Group, Inc.
3020 South Florida Avenue, Suite 101
Lakeland, Florida 33803
Attn: D. Joel Adams

Except as otherwise provided in this Agreement, any Notice shall be deemed received only upon actual delivery at the address set forth above. Notices delivered after 5:00 p.m. (at the place of delivery) or on a non-business day, shall be deemed received on the next business day. If any time for giving Notice contained in this Agreement would otherwise expire on a non-business day, the Notice period shall be extended to the next succeeding business day. Saturdays, Sundays, and legal holidays recognized by the United States government shall not be regarded as business days. Counsel for the District and counsel for the Developer may deliver Notice on behalf of the District and the Developer. Any Party or other person to whom Notices are to be sent or copied may notify the other parties and addressees of any change in name or address to which Notices shall be sent by providing the same on five (5) days written notice to the Parties and addressees set forth in this Agreement.

SECTION 15. ARM’S LENGTH TRANSACTION. This Agreement has been negotiated fully between the District and the Developer as an arm’s length transaction. All Parties participated fully in the preparation of this Agreement and received the advice of counsel. In the case of a dispute concerning the interpretation of any provision of this Agreement, all Parties are deemed to have drafted, chosen, and selected the language, and the doubtful language will not be interpreted or construed against any Party hereto.

SECTION 16. THIRD PARTY BENEFICIARIES. This Agreement is solely for the benefit of the District and the Developer and no right or cause of action shall accrue upon or by reason, to or for the benefit of any third party not a formal party to this Agreement. Nothing in this Agreement expressed or implied is intended or shall be construed to confer upon any person or entity other than the District and the Developer any right, remedy, or claim under or by reason of this Agreement or any of the provisions or conditions of this Agreement; and all of the provisions, representations, covenants, and conditions contained in this Agreement shall inure to the sole benefit of and shall be binding upon the District and the Developer and their respective representatives, successors, and assigns.

SECTION 17. ASSIGNMENT. This Agreement may be assigned, in whole or in part, by either Party only upon the written consent of the other, which consent shall not be unreasonably withheld. Such consent shall not be required in the event of a sale of the majority of the Assessment Area One Project then-owned by the Developer pursuant to which the unaffiliated purchaser agrees to assume any remaining obligations of the Developer under this Agreement. Upon the merger, amendment, or name change of the District, the Agreement will be assumed by operation of law by the District’s successor in interest and no consent to such assumption shall be required.

SECTION 18. APPLICABLE LAW AND VENUE. This Agreement and the provisions contained herein shall be construed, interpreted and controlled according to the laws of the State of Florida. Each Party consents that the exclusive venue for any litigation arising out of or related to this Agreement shall be in a court of appropriate jurisdiction, in and for Osceola County, Florida.

SECTION 19. EFFECTIVE DATE. This Agreement shall be effective upon its execution by the District and the Developer.

SECTION 20. TERMINATION. This Agreement may be terminated by the District without penalty in the event that the District does not issue its proposed Assessment Area One Bonds within five (5) years from the date of this Agreement.

SECTION 21. PUBLIC RECORDS. The Developer understands and agrees that all documents of any kind provided to the District in connection with this Agreement may be public records and will be treated as such in accordance with Florida law.

SECTION 22. SEVERABILITY. The invalidity or unenforceability of any one or more provisions of this Agreement shall not affect the validity or enforceability of the remaining portions of this Agreement, or any part of this Agreement not held to be invalid or unenforceable.

SECTION 23. LIMITATIONS ON GOVERNMENTAL LIABILITY. Nothing in this Agreement shall be deemed as a waiver of immunity or limits of liability of the District beyond any statutory limited waiver of immunity or limits of liability which may have been adopted by the Florida Legislature in section 768.28, *Florida Statutes*, or other statute, and nothing in this Agreement shall inure to the benefit of any third party for the purpose of allowing any claim which would otherwise be barred under the Doctrine of Sovereign Immunity or by operation of law.

SECTION 24. HEADINGS FOR CONVENIENCE ONLY. The descriptive headings in this Agreement are for convenience only and shall not control nor affect the meaning or construction of any of the provisions of this Agreement.

SECTION 25. COUNTERPARTS. This Agreement may be executed in any number of counterparts, each of which when executed and delivered shall be an original; however, all such counterparts together shall constitute but one and the same instrument. Signature and acknowledgment pages, if any, may be detached from the counterparts and attached to a single copy of this document to physically form one document.

[Remainder of this page left intentionally blank]

IN WITNESS WHEREOF, the Parties execute this Agreement the day and year first written above.

ATTEST:

**HICKORY TREE COMMUNITY
DEVELOPMENT DISTRICT**

Secretary/Assistant Secretary

Milton Andrade
Chairperson, Board of Supervisors

WITNESS:

**CLAYTON PROPERTIES GROUP,
INC.**, a Tennessee corporation

[Print Name]

D. Joel Adams, Vice President

Exhibit A: *Engineer's Reports*

Exhibit B: Legal Description of Assessment Area One (CDD Boundary)

**EXHIBIT A
ENGINEER'S REPORTS**

[TO BE ATTACHED]

EXHIBIT B
LEGAL DESCRIPTION OF ASSESSMENT AREA ONE

SECTION E

This instrument was prepared by and upon recording should be returned to:

Jennifer Kilinski, Esq.
KILINSKI | VAN WYK PLLC
517 East College Avenue
Tallahassee Florida 32301

**DECLARATION OF CONSENT TO JURISDICTION OF
HICKORY TREE COMMUNITY DEVELOPMENT DISTRICT
AND TO IMPOSITION OF SPECIAL ASSESSMENTS
(ASSESSMENT AREA ONE ASSESSMENTS)**

Clayton Properties Group, Inc., a Tennessee corporation (the “**Landowner**”), is the owner of those lands as more particularly described in **Exhibit A** attached hereto (the “**Property**” also known as “**Assessment Area One**”), located within the boundaries of the Hickory Tree Community Development District (the “**District**”). The Landowner, intending that it and its successors in interest and assigns shall be legally bound by this Declaration and Consent, hereby declares, acknowledges and agrees as follows:

1. The District is, has been, and has remained at all times, on and after June 29, 2022, a legally created, duly organized, and validly existing community development district under the provisions of Chapter 190, *Florida Statutes*, as amended (the “**Act**”). Without limiting the generality of the foregoing, the Landowner acknowledges that: (a) the petition filed with the Osceola County Board of County Commissioners (“**County**”), relating to the creation of the District contained all matters required by the Act to be contained therein and was filed in the manner and by the persons required by the Act; (b) Ordinance No. 2022-60, enacted by the County and effective on June 29, 2022 (the “**Ordinance**”), was duly and properly adopted by the County in compliance with all applicable requirements of law; (c) the members of the Board of Supervisors of the District (the “**Board**”) were and are duly and properly designated and/or elected pursuant to the Act to serve in their official capacities and had the authority and right to authorize, approve and undertake all actions of the District approved and undertaken from June 29, 2022 to and including the date of this Declaration.

2. The Landowner, for itself and its heirs, successors and assigns, hereby confirms and agrees, that the debt special assessments (the “**Assessment Area One Assessments**”) imposed by, but not limited to, Resolution Nos. 2022-27, 2022-28, 2022-36 and 2023-08 (collectively, the “**Assessment Resolutions**”) have been duly adopted by the Board, and all proceedings undertaken by the District with respect thereto have been in accordance with applicable Florida law, that the District has taken all action necessary to levy and impose the Assessment Area One Assessments, and the Assessment Area One Assessments are legal, valid and binding first liens upon the Property co-equal with the lien of all state, county, city, district and municipal taxes, superior in dignity to all other liens, titles and claims, until paid.

3. The Landowner, for itself and its heirs, successors and assigns, hereby waives the right granted in Chapter 170.09, *Florida Statutes*, to prepay the Assessment Area One Assessments without interest within thirty (30) days after the improvements are completed, in consideration of the rights granted by the District to prepay the Assessment Area One Assessments in full at any time or in part at any time, but with interest, under the circumstances set forth in the Assessment Resolutions of the District levying the Assessment Area One Assessments.

4. The Landowner hereby expressly acknowledges, represents and agrees that (i) the Assessment Area One Assessments, the Assessment Resolutions, and the terms of the financing documents related to the District's issuance of the Hickory Tree Community Development District Special Assessment Bonds, Assessment Area One, in the principal amount of \$_____ (the "**Assessment Area One Bonds**"), or securing payment thereof and all other documents and certifications relating to the issuance of the Assessment Area One Bonds (the "**Financing Documents**"), are valid and binding obligations enforceable in accordance with their terms; (ii) there are no claims or offsets whatsoever against, or defenses or counterclaims whatsoever to, payments of the Assessment Area One Assessments or claims of invalidity, deficiency or unenforceability of the Assessment Area One Assessments and Financing Documents (and the Landowner hereby expressly waives any such claims, offsets, defenses or counterclaims); (iii) the Landowner expressly waives and relinquishes any argument, claim or defense that foreclosure proceedings cannot be commenced until one (1) year after the date of the Landowner's default and agrees that, immediate use of remedies in Chapter 170, *Florida Statutes*, is an appropriate and available remedy, notwithstanding the provisions of Section 190.026, *Florida Statutes*; (iv) to the extent Landowner fails to timely pay any Assessment Area One Assessments collected by mailed notice of the District, such unpaid Assessment Area One Assessments and future Assessment Area One Assessments may be placed on the tax roll by the District for collection by the Tax Collector pursuant to Section 197.3632, *Florida Statutes*, in any subsequent year; and (v) any and all rights to challenge the validity of: any argument, claim or defense resulting from any defect or omission of any and all District notices, meetings, workshops, public hearings and other proceedings in relation to the Assessment Area One Assessments or the Assessment Area One Bonds that were conducted on or prior to the date hereof.

5. This Declaration shall represent a lien of record for purposes of Chapter 197, *Florida Statutes*, including, without limitation, Section 197.573, *Florida Statutes*. Other information regarding the Assessment Area One Assessments is available from the District Manager (Governmental Management Services – Central Florida, LLC), 219 East Livingston Street, Orlando, Florida 32801.

THE DECLARATIONS, ACKNOWLEDGEMENTS AND AGREEMENTS CONTAINED HEREIN SHALL BE BINDING ON THE LANDOWNER AND ON ALL PERSONS (INCLUDING CORPORATIONS, ASSOCIATIONS, TRUSTS AND OTHER LEGAL ENTITIES) TAKING TITLE TO ALL OR ANY PART OF THE PROPERTY, AND THEIR SUCCESSORS IN INTEREST, WHETHER OR NOT THE PROPERTY IS PLATTED AT SUCH TIME. BY TAKING SUCH TITLE, SUCH PERSONS SHALL BE DEEMED TO HAVE CONSENTED AND AGREED TO THE PROVISIONS OF THIS DECLARATION TO THE SAME EXTENT AS IF THEY HAD EXECUTED IT AND BY TAKING SUCH TITLE, SUCH PERSONS SHALL BE ESTOPPED FROM CONTESTING, IN COURT OR OTHERWISE, THE VALIDITY, LEGALITY AND ENFORCEABILITY OF THIS DECLARATION.

EFFECTIVE THIS ____ day of September, 2023.

IN WITNESS WHEREOF, the Landowner has caused this Declaration and Consent to be executed and delivered on the day and year first written above.

WITNESSES:

CLAYTON PROPERTIES GROUP, INC.,
a Tennessee corporation

Witness Signature

Printed name: _____

By: D. Joel Adams

Its: Vice President

Witness Signature

Printed name: _____

STATE OF FLORIDA)
COUNTY OF _____)

The foregoing instrument was acknowledged before me by means of physical presence or online notarization this ____ day of September, 2023, by D. Joel Adams, as Vice President of **Clayton Properties Group, Inc.**, for and on behalf of said entity. He is personally known to me or produced _____ as identification.

NOTARY STAMP:

Signature of Notary Public

Printed Name of Notary Public

EXHIBIT A
LEGAL DESCRIPTION OF ASSESSMENT AREA ONE ASSESSMENT AREA

SECTION F

RESOLUTION 2023-08

**[ASSESSMENT AREA ONE BONDS]
SUPPLEMENTAL ASSESSMENT RESOLUTION
WITH DELEGATION OF AUTHORITY**

A RESOLUTION SETTING FORTH THE SPECIFIC TERMS OF THE DISTRICT’S SPECIAL ASSESSMENT REVENUE BONDS, SERIES 2023 (ASSESSMENT AREA ONE PROJECT) (“ASSESSMENT AREA ONE BONDS”); MAKING CERTAIN ADDITIONAL FINDINGS AND ADOPTING AND CONFIRMING AN ENGINEER’S REPORT AND A SUPPLEMENTAL ASSESSMENT REPORT; DELEGATING AUTHORITY TO PREPARE FINAL REPORTS AND UPDATE THIS RESOLUTION; CONFIRMING THE MAXIMUM ASSESSMENT LIEN SECURING THE BONDS; ADDRESSING THE ALLOCATION AND COLLECTION OF THE ASSESSMENTS SECURING THE ASSESSMENT AREA ONE BONDS; ADDRESSING PREPAYMENTS; ADDRESSING TRUE-UP PAYMENTS; PROVIDING FOR THE SUPPLEMENTATION OF THE IMPROVEMENT LIEN BOOK; AND PROVIDING FOR CONFLICTS, SEVERABILITY AND AN EFFECTIVE DATE.

WHEREAS, the Hickory Tree Community Development District (“**District**”) previously indicated its intention to undertake, install, establish, construct or acquire certain public improvements and to finance such public improvements through the issuance of bonds secured by the imposition of special assessments on benefited property within the District; and

WHEREAS, the District’s Board of Supervisors (“**Board**”) has previously adopted, after proper notice and public hearing, Resolutions No. 2022-27, 2022-28, and 2022-36 (together, “**Master Assessment Resolution**”), relating to the imposition, levy, collection and enforcement of such special assessments, and establishing a master lien over the property within the District, which lien remains inchoate until the District issues bonds, as provided in the Master Assessment Resolution; and

WHEREAS, the Master Assessment Resolution provides that as each series of bonds is issued to fund all or any portion of the District’s improvements, a supplemental resolution may be adopted to set forth the specific terms of the bonds and certify the amount of the lien of the special assessments securing any portion of the bonds, including interest, costs of issuance, the number of payments due, and the application of receipt of any true-up proceeds; and

WHEREAS, on September 6, 2023, and in order to finance all or a portion of what is known as the Assessment Area One Project, as defined herein, the District adopted Resolution 2023-____ (“**Delegated Award Resolution**”), which authorized the District to enter into a *Bond Purchase*

Agreement and other agreements, and sell its Special Assessment Revenue Bonds, Series 2023 (Assessment Area One Project) (the “**Assessment Area One Bonds**”) within certain parameters set forth in the Delegated Award Resolution; and

WHEREAS, the District intends to secure the Assessment Area One Bonds by levying debt service special assessments on benefiting property in Assessment Area One (as defined herein) (“**Assessment Area One Assessments**”) pursuant to the terms of the Master Assessment Resolution, and in accordance with the master and supplemental trust indentures applicable to the Assessment Area One Bonds; and

WHEREAS, pursuant to and consistent with the Master Assessment Resolution and Delegated Award Resolution, the District desires to authorize the finalization of its Assessment Area One Assessments, among other actions.

NOW THEREFORE, BE IT RESOLVED BY THE BOARD OF SUPERVISORS OF THE HICKORY TREE COMMUNITY DEVELOPMENT DISTRICT AS FOLLOWS:

1. **INCORPORATION OF RECITALS.** All of the above representations, findings and determinations contained above are recognized as true and accurate and are expressly incorporated into this Resolution.

2. **AUTHORITY FOR THIS RESOLUTION.** This Resolution is adopted pursuant to the provisions of Florida law, including Chapters 170, 190 and 197, *Florida Statutes*, and the Master Assessment Resolution.

3. **ADDITIONAL FINDINGS; ADOPTION OF ENGINEER’S REPORT AND SUPPLEMENTAL ASSESSMENT REPORT.** The Board hereby finds and determines as follows:

- a. The *Hickory Tree Community Development District Engineer’s Report*, dated June 28, 2022 (“**Master Engineer’s Report**”), as supplemented by the *Hickory Tree Community Development District Supplemental Engineer’s Report (Assessment Area One)*, dated September 6, 2023, attached to this Resolution as **Exhibit A** (“**Supplemental Engineer’s Report**” and together with the Master Engineer’s Report, the “**Engineer’s Report**”), identifies and describes, among other things, the presently expected components and estimated costs of the District’s Capital Improvement Plan (the portion identified in the Supplemental Engineer’s Report and which is anticipated to be financed with the Assessment Area One Bonds, being hereinafter called the “**Assessment Area One Project**”). The District hereby confirms that the Assessment Area One Project serves a proper, essential and valid public purpose. The Supplemental Engineer’s Report is hereby approved, adopted, and confirmed in substantial form. The District authorizes and ratifies its use in connection with the sale of the Assessment Area One Bonds, subject to any changes deemed necessary under Section 4.a herein.

- b. The *First Supplemental Assessment Methodology (Assessment Area One Project)*, dated September 6, 2023, attached to this Resolution as **Exhibit B** (“**Supplemental Assessment Methodology Report**”), applies the master assessment methodology set forth in the *Master Assessment Methodology for Hickory Tree Community Development District*, dated June 28, 2022 (“**Master Assessment Methodology Report**” and, together with the Supplemental Assessment Methodology Report, the “**Assessment Methodology Report**”) to the Assessment Area One Project and, as finalized, to the actual terms of the Assessment Area One Bonds. The Assessment Methodology Report is hereby approved, adopted and confirmed in substantial form. The District authorizes and ratifies its use in connection with the sale of the Assessment Area One Bonds, subject to any changes deemed necessary under Section 4.a. herein.
- c. Generally speaking, and subject to the terms of **Exhibit A** and **Exhibit B**, the Assessment Area One Project benefits all developable property within the District, including Assessment Area One, as described in **Exhibit C** attached hereto. Moreover, the benefits from the Assessment Area One Project funded by the Assessment Area One Bonds equal or exceed the amount of the Assessment Area One Assessments, as described in **Exhibit B**, and such Assessment Area One Assessments are fairly and reasonably allocated across all developable property in the District. It is reasonable, proper, just and right to assess the portion of the costs of the Assessment Area One Project to be financed with the Assessment Area One Bonds to the specially benefited properties within the District as set forth in Master Assessment Resolution and this Resolution.

4. **CONFIRMATION OF MAXIMUM ASSESSMENT LIEN SECURING THE ASSESSMENT AREA ONE BONDS; DELEGATION OF AUTHORITY FOR DISTRICT STAFF TO ISSUE FINAL REPORTS AND UPDATE THIS RESOLUTION.** As provided in the Master Assessment Resolution, this Resolution is intended to set forth the terms of the Assessment Area One Bonds and the final amount of the lien of the Assessment Area One Assessments. In connection with the closing on the sale of the Assessment Area One Bonds, District Staff is authorized to:

- a. Prepare final versions of the Supplemental Engineer’s Report and Supplemental Assessment Methodology Report attached hereto as **Exhibit A** and **Exhibit B**, respectively, to incorporate final pricing terms and make such other revisions as may be deemed necessary, provided however that:
 - i. the Assessment Area One Assessments shall be levied and imposed within the parameters of the Master Assessment Resolution and Delegated Award Resolution; and
 - ii. the final versions shall be approved by the Chairperson or, in the Chairperson’s absence, the Vice Chairperson, and in the absence or

unavailability of the Vice Chairperson, any other member of the Board; and

- iii. the actual amounts financed, costs of issuance, expected costs of collection, and the total amount of assessments pledged to the issuance of the Assessment Area One Bonds, which amount shall be consistent with the lien imposed by the Master Assessment Resolution, shall all be as set forth in the final Supplemental Assessment Report.
- b. After pricing, there shall be attached **Composite Exhibit D** to this Resolution showing: (i) Maturities and Coupon of Assessment Area One Bonds, (ii) Sources and Uses of Funds for Assessment Area One Bonds, and (iii) Annual Debt Service Payment Due on Assessment Area One Bonds.
- c. Upon closing on the District's Assessment Area One Bonds, the District's Secretary is hereby authorized and directed to record a Notice of Assessment Area One Assessments in the Official Records of Osceola County, Florida, or such other instrument evidencing the actions taken by the District. The lien of the Assessment Area One Assessments shall be the principal amount due on the Assessment Area One Bonds, together with interest and collection costs, and other pledged revenues as set forth in the applicable indenture(s) and shall cover all developable acreage within Assessment Area One, as further provided in the Assessment Area One Assessment Roll included in the Supplemental Assessment Methodology Report, and as such land is ultimately defined and set forth in site plans or other designations of developable acreage. To the extent that land is added to the District and made subject to the master assessment lien described in the Master Assessment Methodology Report, the District may, by supplemental resolution at a regularly noticed meeting and without the need for a public hearing on reallocation, determine such land to be benefitted by the Assessment Area One Project and reallocate the Assessment Area One Assessments securing the Assessment Area One Bonds in order to impose Assessment Area One Assessments on the newly added and benefitted property, as may be applicable.

5. **ALLOCATION AND COLLECTION OF THE ASSESSMENT AREA ONE ASSESSMENTS.**

- a. The Assessment Area One Assessments shall be allocated in accordance with **Exhibit B** and the Master Assessment Report. The final Supplemental Assessment Methodology Report shall reflect the actual terms of the issuance of the Assessment Area One Bonds. The Assessment Area One Assessments shall be paid in not more than thirty (30) years of installments of principal and interest.

- b. The Assessment Area One Bonds are payable from and secured by the Assessment Area One Pledged Revenues. The Assessment Area One Pledged Revenues consist primarily of the revenues received by the District from the Assessment Area One Assessments levied against certain lands in the District that are subject to assessment as a result of the Assessment Area One Project or any portion thereof.
- c. The District hereby certifies the Assessment Area One Assessments for collection and authorizes and directs staff to take all actions necessary to meet the time and other deadlines imposed for collection by Osceola County and other Florida law. The District's Board each year shall adopt a resolution addressing the manner in which the Assessment Area One Assessments shall be collected for the upcoming fiscal year. The decision to collect Assessment Area One Assessments by any particular method – e.g., on the tax roll or by direct bill – does not mean that such method will be used to collect the Assessment Area One Assessments in future years, and the District reserves the right in its sole discretion to select collection methods in any given year, regardless of past practices.

6. **IMPACT FEE CREDITS.** In lieu of receiving impact fee credits (if any) from any public improvements financed by the District, the District may elect to receive a contribution of infrastructure, reduce the cost of acquiring the improvements, or otherwise address the credits, as set forth in any applicable *Acquisition Agreement* between the District and the project developer(s) and/or landowner(s).

7. **PREPAYMENT OF ASSESSMENT AREA ONE ASSESSMENTS.** Any owner of property subject to the Assessment Area One Assessments may, at its option, pre-pay the entire amount of such applicable assessments any time, or a portion of the amount of such assessments up to two (2) times (or as otherwise provided by the applicable Supplemental Indenture for the respective series of Assessment Area One Bonds), plus any applicable interest (as provided for in the applicable Supplemental Indenture for the Assessment Area One Bonds), attributable to the property subject to the applicable Assessment Area One Assessments owned by such owner. In connection with any prepayment of Assessment Area One Assessments, the District may grant a discount equal to all or part of the payee's proportionate share of financing costs (e.g., reserves) to the extent such discounts are provided for under the applicable Supplemental Indenture. Except as otherwise set forth herein, the terms of the Master Assessment Resolution addressing prepayment of assessments shall continue to apply in full force and effect.

8. **APPLICATION OF TRUE-UP PAYMENTS.** The terms of the Master Assessment Resolution addressing True-Up Payments, as defined therein, shall continue to apply in full force and effect.

9. **IMPROVEMENT LIEN BOOK.** Immediately following the closing on the District's Assessment Area One Bonds, the Assessment Area One Assessments as reflected herein shall be recorded by the Secretary of the Board in the District's Improvement Lien Book. The Assessment Area One Assessments shall be and shall remain a legal, valid and binding first lien against all

benefitted property as described in **Exhibit B** until paid and such lien shall be coequal with the lien of all state, county, district, municipal or other governmental taxes and superior in dignity to all other liens, titles, and claims.

10. **ADDITIONAL AUTHORIZATION.** The Chairperson, the Secretary, and all other Supervisors, officers and staff of the District are hereby authorized and directed to take all actions necessary or desirable in connection with the issuance and delivery of the Assessment Area One Bonds, and final levy of the Assessment Area One Assessments, and the consummation of all transactions in connection therewith, including the execution of all certificates, documents, papers, notices, and agreements necessary to the undertaking and fulfillment of all transactions referred to in or contemplated by the this Resolution. The Vice Chairperson is hereby authorized to act in the stead of the Chairperson in any undertaking authorized or required of the Chairperson hereunder, and in the absence of the Chairperson and Vice Chairperson, any other member of the District's Board of Supervisors is so authorized, and any Assistant Secretary is hereby authorized to act in the stead of the Secretary in any undertaking authorized or required of the Secretary hereunder.

11. **CONFLICTS.** This Resolution is intended to supplement the Master Assessment Resolution, which remains in full force and effect and is applicable to the Assessment Area One Bonds except as modified herein. This Resolution and the Master Assessment Resolution shall be construed to the maximum extent possible to give full force and effect to the provisions of each resolution, provided however that to the extent of any conflict, this Resolution shall control. All District resolutions or parts thereof in actual conflict with this Resolution are, to the extent of such conflict, superseded and repealed.

12. **SEVERABILITY.** If any section or part of a section of this Resolution is declared invalid or unconstitutional, the validity, force and effect of any other section or part of a section of this Resolution shall not thereby be affected or impaired unless it clearly appears that such other section or part of a section of this Resolution is wholly or necessarily dependent upon the section or part of a section so held to be invalid or unconstitutional.

13. **EFFECTIVE DATE.** This Resolution shall become effective upon its adoption.

[REMAINDER OF PAGE INTENTIONALLY LEFT BLANK]

APPROVED and **ADOPTED** this 6th day of September 2023.

ATTEST:

**HICKORY TREE COMMUNITY
DEVELOPMENT DISTRICT**

Secretary

Chairperson

- Exhibit A:** *Hickory Tree Community Development District Supplemental Engineer's Report (Assessment Area One), dated September 6, 2023*
- Exhibit B:** *First Supplemental Assessment Methodology (Assessment Area One Project), dated September 6, 2023*
- Exhibit C:** Legal Description of Assessment Area One
- Comp. Exhibit D:** Maturities and Coupon of Assessment Area One Bonds
Sources and Uses of Funds for Assessment Area One Bonds
Annual Debt Service Payment Due on Assessment Area One Bonds

EXHIBIT A

EXHIBIT B

EXHIBIT C

COMPOSITE EXHIBIT D

SECTION VIII

August 14, 2023

Hickory Tree Community Development District
Board of Supervisors

We are pleased to confirm our understanding of the services we are to provide Hickory Tree Community Development District, ("the District") for the fiscal years ended September 30, 2023, 2024, 2025, 2026 and 2027.

Audit Scope and Objectives

We will audit the financial statements of the governmental activities, the business-type activities, the aggregate discretely presented component units, each major fund, and the aggregate remaining fund information, and the disclosures, which collectively comprise the basic financial statements of the District as of and for the years ended September 30, 2023, 2024, 2025, 2026 and 2027. Accounting standards generally accepted in the United States of America (GAAP) provide for certain required supplementary information (RSI), such as management's discussion and analysis (MD&A), to supplement the District's basic financial statements. Such information, although not a part of the basic financial statements, is required by the Governmental Accounting Standards Board who considers it to be an essential part of financial reporting for placing the basic financial statements in an appropriate operational, economic, or historical context. As part of our engagement we will apply certain limited procedures to the District's RSI in accordance with auditing standards generally accepted in the United States of America (GAAS). These limited procedures will consist of inquiries of management regarding the methods of preparing the information and comparing the information for consistency with management's responses to our inquiries, the basic financial statements, and other knowledge we obtained during our audit of the basic financial statements. We will not express an opinion or provide any assurance on the information because the limited procedures do not provide us with sufficient appropriate evidence to express an opinion or provide any assurance. The following RSI is required by GAAP and will be subjected to certain limited procedures, but will not be audited.

1. Management's Discussion and Analysis
2. Budgetary comparison schedule

The objectives of our audit are to obtain reasonable assurance as to whether the financial statements as a whole are free from material misstatement, whether due to fraud or error; issue an auditor's report that includes our opinion about whether your financial statements are fairly presented, in all material respects, in conformity with GAAP; and report on the fairness of the supplementary information referred to in the second paragraph when considered in relation to the financial statements as a whole. Reasonable assurance is a high level of assurance but is not absolute assurance and therefore is not a guarantee that an audit conducted in accordance with GAAS will always detect a material misstatement when it exists. Misstatements, including omissions, can arise from fraud or error and are considered material if there is a substantial likelihood that, individually or in the aggregate, they would influence the judgment of a reasonable user made based on the financial statements.

Auditor's Responsibilities for the Audit of the Financial Statements

We will conduct our audit in accordance with GAAS and will include tests of your accounting records and other procedures we consider necessary to enable us to express such opinions. As part of an audit in accordance with GAAS, we exercise professional judgment and maintain professional skepticism throughout the audit.

We will evaluate the appropriateness of accounting policies used and the reasonableness of significant accounting estimates made by management. We will also evaluate the overall presentation of the financial statements, including the disclosures, and determine whether the financial statements represent the underlying transactions and events in a manner that achieves fair presentation. We will plan and perform the audit to obtain reasonable assurance about whether the financial statements are free of material misstatement, whether from (1) errors, (2) fraudulent financial reporting, (3) misappropriation of assets, or (4) violations of laws or governmental regulations that are attributable to the government or to acts by management or employees acting on behalf of the government.

Because of the inherent limitations of an audit, combined with the inherent limitations of internal control, and because we will not perform a detailed examination of all transactions, there is an unavoidable risk that some material misstatements may not be detected by us, even though the audit is properly planned and performed in accordance with GAAS. In addition, an audit is not designed to detect immaterial misstatements or violations of laws or governmental regulations that do not have a direct and material effect on the financial statements. However, we will inform the appropriate level of management of any material errors, fraudulent financial reporting, or misappropriation of assets that comes to our attention. We will also inform the appropriate level of management of any violations of laws or governmental regulations that come to our attention, unless clearly inconsequential. Our responsibility as auditors is limited to the period covered by our audit and does not extend to any later periods for which we are not engaged as auditors.

We will also conclude, based on the audit evidence obtained, whether there are conditions or events, considered in the aggregate, that raise substantial doubt about the government's ability to continue as a going concern for a reasonable period of time.

Our procedures will include tests of documentary evidence supporting the transactions recorded in the accounts, tests of the physical existence of inventories, and direct confirmation of receivables and certain assets and liabilities by correspondence with selected customers, creditors, and financial institutions. We will also request written representations from your attorneys as part of the engagement.

We may, from time to time and depending on the circumstances, use third-party service providers in serving your account. We may share confidential information about you with these service providers but remain committed to maintaining the confidentiality and security of your information. Accordingly, we maintain internal policies, procedures, and safeguards to protect the confidentiality of your personal information. In addition, we will secure confidentiality agreements with all service providers to maintain the confidentiality of your information and we will take reasonable precautions to determine that they have appropriate procedures in place to prevent the unauthorized release of your confidential information to others. In the event that we are unable to secure an appropriate confidentiality agreement, you will be asked to provide your consent prior to the sharing of your confidential information with the third-party service provider. Furthermore, we will remain responsible for the work provided by any such third-party service providers.

Our audit of the financial statements does not relieve you of your responsibilities.

Audit Procedures—Internal Control

We will obtain an understanding of the government and its environment, including internal control relevant to the audit, sufficient to identify and assess the risks of material misstatement of the financial statements, whether due to error or fraud, and to design and perform audit procedures responsive to those risks and obtain evidence that is sufficient and appropriate to provide a basis for our opinions. The risk of not detecting a material misstatement resulting from fraud is higher than for one resulting from error, as fraud may involve collusion, forgery, intentional omissions, misrepresentation, or the override of internal control. An audit is not designed to provide assurance on internal control or to identify deficiencies in internal control. Accordingly, we will express no such opinion. However, during the audit, we will communicate to management and those charged with governance internal control related matters that are required to be communicated under AICPA professional standards.

Audit Procedures—Compliance

As part of obtaining reasonable assurance about whether the financial statements are free of material misstatement, we will perform tests of the District's compliance with the provisions of applicable laws, regulations, contracts, and agreements. However, the objective of our audit will not be to provide an opinion on overall compliance and we will not express such an opinion.

Other Services

We will also prepare the financial statements of Hickory Tree Community Development District in conformity with accounting principles generally accepted in the United States of America based on information provided by you.

We will perform the services in accordance with applicable professional standards. The other services are limited to the financial statement services previously defined. We, in our sole professional judgment, reserve the right to refuse to perform any procedure or take any action that could be construed as assuming management responsibilities.

You agree to assume all management responsibilities for the financial statement preparation services and any other nonattest services we provide; oversee the services by designating an individual, preferably from senior management, with suitable skill, knowledge, or experience; evaluate the adequacy and results of the services; and accept responsibility for them.

Responsibilities of Management for the Financial Statements

Our audit will be conducted on the basis that you acknowledge and understand your responsibility for designing, implementing, and maintaining internal controls relevant to the preparation and fair presentation of financial statements that are free from material misstatement, whether due to fraud or error, including monitoring ongoing activities; for the selection and application of accounting principles; and for the preparation and fair presentation of the financial statements in conformity with accounting principles generally accepted in the United States of America with the oversight of those charged with governance.

Management is responsible for making information available for the drafting of financial statements, all financial records, and related information available to us and for the accuracy and completeness of that information (including information from outside of the general and subsidiary ledgers). You are also responsible for providing us with (1) access to all information of which you are aware that is relevant to the preparation and fair presentation of the financial statements, such as records, documentation, identification of all related parties and all related-party relationships and transactions, and other matters; (2) additional information that we may request for the purpose of the audit; and (3) unrestricted access to persons within the government from whom we determine it necessary to obtain audit evidence. At the conclusion of our audit, we will require certain written representations from you about the financial statements and related matters.

Your responsibilities include adjusting the financial statements to correct material misstatements and confirming to us in the management representation letter that the effects of any uncorrected misstatements aggregated by us during the current engagement and pertaining to the latest period presented are immaterial, both individually and in the aggregate, to the financial statements of each opinion unit taken as a whole.

You are responsible for the design and implementation of programs and controls to prevent and detect fraud, and for informing us about all known or suspected fraud affecting the government involving (1) management, (2) employees who have significant roles in internal control, and (3) others where the fraud could have a material effect on the financial statements. Your responsibilities include informing us of your knowledge of any allegations of fraud or suspected fraud affecting the government received in communications from employees, former employees, grantors, regulators, or others. In addition, you are responsible for identifying and ensuring that the government complies with applicable laws and regulations.

You are responsible for the preparation of the supplementary information in conformity with accounting principles generally accepted in the United States of America (GAAP). You agree to include our report on the supplementary information in any document that contains, and indicates that we have reported on, the supplementary information. You also agree to include the audited financial statements with any presentation of the supplementary information that includes our report thereon. Your responsibilities include acknowledging to us in the representation letter that (1) you are responsible for presentation of the supplementary information in accordance with GAAP; (2) you believe the supplementary information, including its form and content, is fairly presented in accordance with GAAP; (3) the methods of measurement or presentation have not changed from those used in the prior period (or, if they have changed, the reasons for such changes); and (4) you have disclosed to us any significant assumptions or interpretations underlying the measurement or presentation of the supplementary information.

Engagement Administration, Fees, and Other

We understand that your employees will prepare all cash or other confirmations we request and will locate any documents selected by us for testing.

Subject to applicable laws and regulations, audit documentation and appropriate individuals will be made available upon request and in a timely manner to a cognizant or oversight agency or its designee, a federal agency providing direct or indirect funding, or the U.S. Government Accountability Office for purposes of a quality review of the audit, to resolve audit findings, or to carry out oversight responsibilities. We will notify you of any such request. If requested, access to such audit documentation will be provided under the supervision of DiBartolomeo, McBee, Hartley & Barnes, P.A. personnel. Furthermore, upon request, we may provide copies of selected audit documentation to the aforementioned parties. These parties may intend, or decide, to distribute the copies or information contained therein to others, including other governmental agencies. Notwithstanding the foregoing, the parties acknowledge that various documents reviewed or produced during the conduct of the audit may be public records under Florida law.

We will complete the audit within prescribed statutory deadlines, with the understanding that your employees will provide information needed to perform the audit on a timely basis.

The audit documentation for this engagement will be retained for a minimum of five years after the report release date. If we are aware that a federal awarding agency or auditee is contesting an audit finding, we will contact the party(ies) contesting the audit finding for guidance prior to destroying the audit documentation.

Jim Hartley is the engagement partner and is responsible for supervising the engagement and signing the report or authorizing another individual to sign it. Our fees for these services are not to exceed \$3,250 for the year ending 2023 and \$14,150 for the years ending 2024 - 2027, respectively. The fee estimate is based on anticipated cooperation from your personnel and the assumption that unexpected circumstances will not be encountered during the audit. If significant additional time is necessary or if additional Bonds are issued, we will discuss it with you and arrive at a new fee estimate before we incur the additional costs. Our invoices for these fees will be rendered each month as work progresses and are payable on presentation. If we elect to terminate our services for nonpayment, our engagement will be deemed to have been completed upon written notification of termination, even if we have not completed our report. You will be obligated to compensate us for all time expended and to reimburse us for all out-of-pocket expenditures through the date of termination.

Either party may unilaterally terminate this agreement, with or without cause, upon thirty (30) days written notice. Upon any termination of this Agreement, the District will pay all invoices for services rendered prior to the date of the notice of termination but subject to any offsets that the District may have. Pursuant to Section 218.391, Florida Statutes, all invoices for fees or other compensation must be submitted in sufficient detail to demonstrate compliance with the terms of this engagement.

We shall take all necessary steps to ensure that the audit is completed in a timely fashion so that the financial reports and audits may be approved by the District's Board of Supervisors within 180 days after the end of the fiscal year under review.

We agree and understand that Chapter 119, Florida Statutes, may be applicable to documents prepared in connection with the services provided hereunder and agree to cooperate with public record requests made there under. In connection with this Agreement, we agree to comply with all provisions of Florida's public records laws, including but not limited to Section 119.0701, Florida Statutes, the terms of which are incorporated herein. Among other requirements, we will:

- a. Keep and maintain public records required by the District to perform the service.
- b. Upon request from the District's custodian of public records, provide the District with a copy of the requested records or allow the records to be inspected or copied within a reasonable time at a cost that does not exceed the cost provided in Chapter 119, Florida Statutes or as otherwise provided by law.
- c. Ensure that public records that are exempt or confidential and exempt from public records disclosure requirements are not disclosed except as authorized by law for the duration of the contract term and following completion of the Agreement if the auditor does not transfer the records to the District.

- d. Upon completion of this Agreement, transfer, at no cost, to the District all public records in possession of the auditor or keep and maintain public records required by the District to perform the service. If the auditor transfers all public records to the District upon completion of this Agreement, the auditor shall destroy any duplicate public records that are exempt or confidential and exempt from public records disclosure requirements. If the auditor keeps and maintains public records upon completion of the Agreement, the auditor shall meet all applicable requirements for retaining public records. All records stored electronically must be provided to the District, upon request from the District’s custodian of public records, in a format that is compatible with the information technology systems of the District.

Reporting

We will issue a written report upon completion of our audit of Hickory Tree Community Development District’s financial statements. Our report will be addressed to the Board of Supervisors of the District. Circumstances may arise in which our report may differ from its expected form and content based on the results of our audit. Depending on the nature of these circumstances, it may be necessary for us to modify our opinions, add a separate section, or add an emphasis-of-matter or other-matter paragraph to our auditor’s report, or if necessary, withdraw from this engagement. If our opinions are other than unmodified, we will discuss the reasons with you in advance. If, for any reason, we are unable to complete the audit or are unable to form or have not formed opinions, we may decline to express opinions or withdraw from this engagement.

We appreciate the opportunity to be of service to Hickory Tree Community Development District and believe this letter accurately summarizes the significant terms of our engagement. If you have any questions, please let us know. If you agree with the terms of our engagement as described in this letter, please sign the attached copy and return it to us.

DiBartolomeo, McBee, Hartley & Barnes

DiBartolomeo, McBee, Hartley & Barnes, P.A.

RESPONSE:

This letter **DocuSigned by:** correctly sets forth the understanding of Hickory Tree Community Development District.

Signature: *Milton Andrade*
05F2744F40FE41E...

Title: Chairman

Date: 8/15/2023

SECTION IX

SECTION C

SECTION 1

Hickory Tree Community Development District

Summary of Check Register

July 20, 2023 through August 23, 2023

Fund	Date	Check No.'s	Amount
General Fund	7/27/23	54-55	\$ 218.45
	8/9/23	56-60	\$ 4,192.28
	8/16/23	61	\$ 463.50
Total Amount			\$ 4,874.23

CHECK DATE	VEND#INVOICE..... DATE INVOICE	...EXPENSED TO... YRMO DPT ACCT# SUB SUBCLASS	VENDOR NAME	STATUS	AMOUNTCHECK..... AMOUNT #
7/27/23	00003	7/10/23 6956	202306 310-51300-31500	GENERAL COUNSEL JUN23	*	39.00	
				KILINSKI VAN WYK, PLLC			39.00 000054
7/27/23	00004	6/29/23 88606387	202307 310-51300-48000	NOT OF BUDGET FY24	*	179.45	
				OSCEOLA NEWS-GAZETTE			179.45 000055
8/09/23	00005	8/02/23 BW080220	202308 310-51300-11000	SUPERVISOR FEES 08/02/23	*	200.00	
				BRIAN WALSH			200.00 000056
8/09/23	00006	8/02/23 GP080220	202308 310-51300-11000	SUPERVISOR FEES 08/02/23	*	200.00	
				GARRET PARKINSON			200.00 000057
8/09/23	00001	8/01/23 16	202308 310-51300-34000	MANAGEMENT FEES AUG23	*	3,125.00	
		8/01/23 16	202308 310-51300-35200	WEBSITE ADMIN AUG23	*	100.00	
		8/01/23 16	202308 310-51300-35100	INFORMATION TECH AUG23	*	150.00	
		8/01/23 16	202308 310-51300-51000	OFFICE SUPPLIES AUG23	*	2.59	
		8/01/23 16	202308 310-51300-42000	POSTAGE AUG23	*	14.69	
				GOVERNMENTAL MANAGEMENT SERVICES			3,392.28 000058
8/09/23	00007	8/02/23 JS080220	202308 310-51300-11000	SUPERVISOR FEES 08/02/23	*	200.00	
				JEFFREY T. SHENEFIELD			200.00 000059
8/09/23	00008	8/02/23 MA080220	202308 310-51300-11000	SUPERVISOR FEES 08/02/23	*	200.00	
				MILTON ANDRADE			200.00 000060
8/16/23	00003	8/08/23 7187	202307 310-51300-31500	GENERAL COUNSEL JUL23	*	463.50	
				KILINSKI VAN WYK, PLLC			463.50 000061
				TOTAL FOR BANK A		4,874.23	
				TOTAL FOR REGISTER		4,874.23	

HKTR HICKORY TREE ZYAN

SECTION 2

Hickory Tree
Community Development District

Unaudited Financial Reporting
July 31, 2023



Table of Contents

1	<hr/>	<u>Balance Sheet</u>
2	<hr/>	<u>General Fund</u>
3	<hr/>	<u>Capital Project Funds</u>
4	<hr/>	<u>Month to Month</u>

Hickory Tree
Community Development District
Combined Balance Sheet
July 31, 2023

	<i>General Fund</i>	<i>Capital Projects Fund</i>	<i>Totals Governmental Funds</i>
Assets:			
Cash:			
Operating Account	\$ 25,536	\$ -	\$ 25,536
Total Assets	\$ 25,536	\$ -	\$ 25,536
Liabilities:			
Accounts Payable	\$ 464	\$ -	\$ 464
Total Liabilities	\$ 464	\$ -	\$ 464
Fund Balance:			
Unassigned	\$ 25,072	\$ -	\$ 25,072
Total Fund Balances	\$ 25,072	\$ -	\$ 25,072
Total Liabilities & Fund Balance	\$ 25,536	\$ -	\$ 25,536

Hickory Tree
Community Development District
General Fund
Statement of Revenues, Expenditures, and Changes in Fund Balance
For The Period Ending July 31, 2023

	Adopted Budget	Prorated Budget Thru 07/31/23	Actual Thru 07/31/23	Variance
Revenues:				
Developer Contributions	\$ 184,310	\$ 60,000	\$ 60,000	\$ -
Total Revenues	\$ 184,310	\$ 60,000	\$ 60,000	\$ -
Expenditures:				
<u>General & Administrative:</u>				
Supervisor Fees	\$ 12,000	\$ 10,000	\$ 1,600	\$ 8,400
Engineering	\$ 15,000	\$ 12,500	\$ -	\$ 12,500
Attorney	\$ 25,000	\$ 20,833	\$ 2,959	\$ 17,875
Annual Audit	\$ 4,000	\$ -	\$ -	\$ -
Assessment Administration	\$ 5,000	\$ -	\$ -	\$ -
Arbitrage	\$ 450	\$ -	\$ -	\$ -
Dissemination	\$ 5,000	\$ -	\$ -	\$ -
Trustee Fees	\$ 3,600	\$ -	\$ -	\$ -
Management Fees	\$ 37,500	\$ 31,250	\$ 31,250	\$ -
Information Technology	\$ 1,800	\$ 1,500	\$ 1,500	\$ -
Website Maintenance	\$ 1,200	\$ 1,000	\$ 2,750	\$ (1,750)
Telephone	\$ 300	\$ 250	\$ -	\$ 250
Postage & Delivery	\$ 1,000	\$ 833	\$ 59	\$ 774
Insurance	\$ 5,000	\$ 5,000	\$ 5,000	\$ -
Printing & Binding	\$ 1,000	\$ 833	\$ -	\$ 833
Legal Advertising	\$ 10,000	\$ 8,333	\$ 526	\$ 7,808
Other Current Charges	\$ 5,000	\$ 4,167	\$ 38	\$ 4,129
Office Supplies	\$ 625	\$ 521	\$ 55	\$ 466
Travel Per Diem	\$ 660	\$ 550	\$ -	\$ 550
Dues, Licenses & Subscriptions	\$ 175	\$ 175	\$ 175	\$ -
Total General & Administrative:	\$ 134,310	\$ 97,746	\$ 45,911	\$ 51,834
<u>Operations & Maintenance</u>				
Field Contingency	\$ 50,000	\$ 41,667	\$ -	\$ 41,667
Total Operations & Maintenance:	\$ 50,000	\$ 41,667	\$ -	\$ 41,667
Total Expenditures	\$ 184,310	\$ 139,413	\$ 45,911	\$ 93,501
Excess (Deficiency) of Revenues over Expenditures	\$ -		\$ 14,089	
Fund Balance - Beginning	\$ -		\$ 10,984	
Fund Balance - Ending	\$ -		\$ 25,072	

Hickory Tree

Community Development District

Capital Projects Fund

Statement of Revenues, Expenditures, and Changes in Fund Balance

For The Period Ending July 31, 2023

	Adopted Budget	Prorated Budget Thru 07/31/23	Actual Thru 07/31/23	Variance
Revenues				
Interest	\$ -	\$ -	\$ -	\$ -
Total Revenues	\$ -	\$ -	\$ -	\$ -
Expenditures:				
Capital Outlay	\$ -	\$ -	\$ 9,344	\$ (9,344)
Capital Outlay - COI	\$ -	\$ -	\$ 6,537	\$ (6,537)
Total Expenditures	\$ -	\$ -	\$ 15,881	\$ (15,881)
Excess (Deficiency) of Revenues over Expenditures	\$ -	\$ -	\$ (15,881)	
Other Financing Sources/(Uses)				
Developer Advances	\$ -	\$ -	\$ 19,221	\$ 19,221
Total Other Financing Sources (Uses)	\$ -	\$ -	\$ 19,221	\$ 19,221
Net Change in Fund Balance	\$ -	\$ -	\$ 3,341	
Fund Balance - Beginning	\$ -	\$ -	\$ (3,341)	
Fund Balance - Ending	\$ -	\$ -	\$ -	

Hickory Tree
Community Development District
Month to Month

	Oct	Nov	Dec	Jan	Feb	March	April	May	June	July	Aug	Sept	Total
Revenues:													
Developer Contributions	\$ 20,000	\$ -	\$ -	\$ -	20,000	\$ -	\$ -	\$ -	\$ -	20,000	\$ -	\$ -	60,000
Total Revenues	\$ 20,000	\$ -	\$ -	\$ -	20,000	\$ -	\$ -	\$ -	\$ -	20,000	\$ -	\$ -	60,000
Expenditures:													
General & Administrative:													
Supervisor Fees	\$ -	\$ 800	\$ -	\$ -	\$ -	\$ -	\$ 800	\$ -	\$ -	\$ -	\$ -	\$ -	1,600
Engineering	\$ -	\$ -	\$ -	\$ -	\$ -	\$ -	\$ -	\$ -	\$ -	\$ -	\$ -	\$ -	-
Attorney	\$ 279	\$ 570	\$ 38	\$ -	\$ -	\$ 772	\$ 679	\$ 119	\$ 39	\$ 464	\$ -	\$ -	2,959
Management Fees	\$ 3,125	\$ 3,125	\$ 3,125	\$ 3,125	\$ 3,125	\$ 3,125	\$ 3,125	\$ 3,125	\$ 3,125	\$ 3,125	\$ -	\$ -	31,250
Information Technology	\$ 150	\$ 150	\$ 150	\$ 150	\$ 150	\$ 150	\$ 150	\$ 150	\$ 150	\$ 150	\$ -	\$ -	1,500
Website Maintenance	\$ 100	\$ 1,850	\$ 100	\$ 100	\$ 100	\$ 100	\$ 100	\$ 100	\$ 100	\$ 100	\$ -	\$ -	2,750
Telephone	\$ -	\$ -	\$ -	\$ -	\$ -	\$ -	\$ -	\$ -	\$ -	\$ -	\$ -	\$ -	-
Postage & Delivery	\$ 29	\$ 1	\$ 1	\$ 4	\$ 5	\$ 1	\$ 1	\$ 2	\$ 15	\$ 1	\$ -	\$ -	59
Insurance	\$ 5,000	\$ -	\$ -	\$ -	\$ -	\$ -	\$ -	\$ -	\$ -	\$ -	\$ -	\$ -	5,000
Printing & Binding	\$ -	\$ -	\$ -	\$ -	\$ -	\$ -	\$ -	\$ -	\$ -	\$ -	\$ -	\$ -	-
Legal Advertising	\$ 210	\$ -	\$ -	\$ -	\$ -	\$ 62	\$ -	\$ -	\$ -	\$ 253	\$ -	\$ -	526
Other Current Charges	\$ -	\$ -	\$ -	\$ -	\$ -	\$ -	\$ -	\$ -	\$ -	\$ 38	\$ -	\$ -	38
Office Supplies	\$ 46	\$ 5	\$ 0	\$ 0	\$ 0	\$ 0	\$ 0	\$ 3	\$ 0	\$ 0	\$ -	\$ -	55
Travel Per Diem	\$ -	\$ -	\$ -	\$ -	\$ -	\$ -	\$ -	\$ -	\$ -	\$ -	\$ -	\$ -	-
Dues, Licenses & Subscriptions	\$ 175	\$ -	\$ -	\$ -	\$ -	\$ -	\$ -	\$ -	\$ -	\$ -	\$ -	\$ -	175
Total Expenditures	\$ 9,113	\$ 6,501	\$ 3,414	\$ 3,379	\$ 3,381	\$ 4,210	\$ 4,855	\$ 3,499	\$ 3,429	\$ 4,131	\$ -	\$ -	45,911
Excess (Deficiency) of Revenues over Expenditures	\$ 10,887	\$ (6,501)	\$ (3,414)	\$ (3,379)	\$ 16,619	\$ (4,210)	\$ (4,855)	\$ (3,499)	\$ (3,429)	\$ 15,869	\$ -	\$ -	14,089